

Features

- High Performance, Low Power AVR[®] 8-bit Microcontroller
- Advanced RISC Architecture
 - 123 Powerful Instructions – Most Single Clock Cycle Execution
 - 32 x 8 General Purpose Working Registers
 - Fully Static Operation
- Non-volatile Program and Data Memories
 - 4K Bytes of In-System Programmable Program Memory Flash
 - 64 Bytes of In-System Programmable EEPROM
 - 256 Bytes of Internal SRAM
 - Write/Erase Cycles: 10,000 Flash/ 100,000 EEPROM
 - Data Retention: 20 years at 85°C/ 100 years at 25°C
 - Programming Lock for Software Security
- Peripheral Features
 - QTouch[®] Library Support for Capacitive Touch Sensing (8 Channels)
 - Two 8-bit Timer/Counters with two PWM Channels, Each
 - Programmable Watchdog Timer with Separate On-chip Oscillator
 - On-chip Analog Comparator
 - 10-bit ADC
 - 4 Single-ended Channels
 - Universal Serial Interface
 - Boost Converter
- Special Microcontroller Features
 - debugWIRE On-chip Debug System
 - In-System Programmable via SPI Port
 - External and Internal Interrupt Sources
 - Pin Change Interrupt on 16 Pins
 - Low Power Idle, ADC Noise Reduction and Power-down Modes
 - Enhanced Power-on Reset Circuit
 - Programmable Brown-out Detection Circuit
 - Internal Calibrated Oscillator
 - Temperature Sensor On-chip
- I/O and Packages
 - Available in 20-pin SOIC and 20-pin QFN/MLF
 - 16 Programmable I/O Lines
- Operating Voltage:
 - 0.7 – 1.8V (via On-chip Boost Converter)
 - 1.8 – 5.5V (Boost Converter Bypassed)
- Speed Grade
 - Using On-chip Boost Converter
 - 0 – 4 MHz
 - External Power Supply
 - 0 – 4 MHz @ 1.8 – 5.5V
 - 0 – 8 MHz @ 2.7 – 5.5V
- Low Power Consumption
 - Active Mode, 1 MHz System Clock
 - 400 µA @ 3V (Without Boost Converter)
 - Power-down Mode
 - 150 nA @ 3V (Without Boost Converter)



8-bit AVR[®] Microcontroller with 4K Bytes In-System Programmable Flash and Boost Converter

ATtiny43U

Summary

Rev. 8048CS-AVR-02/12



1. Pin Configurations

Figure 1-1. Pinout of ATtiny43U

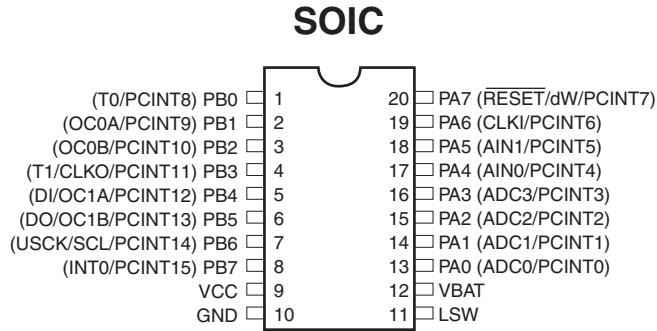

QFN/MLF Top View

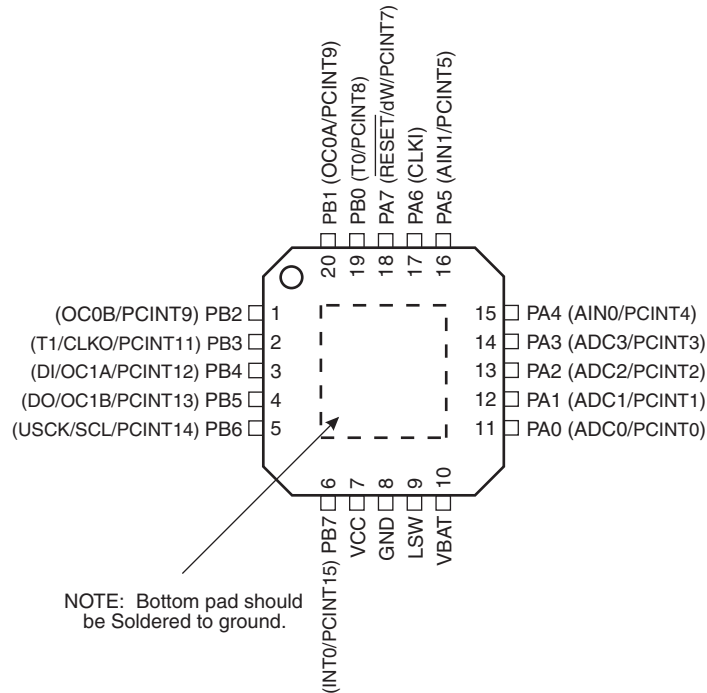

1.1 Pin Descriptions

1.1.1 V_{CC}

Supply voltage.

1.1.2 GND

Ground.

1.1.3 Port A (PA7:PA0)

Port A is a 8-bit bi-directional I/O port with internal pull-up resistors (selected for each bit). The Port A output buffers have symmetrical drive characteristics with both high sink and source

capability except PA7 which has the $\overline{\text{RESET}}$ capability. To use pin PA7 as an I/O pin, instead of RESET pin, program ('0') RSTDISBL fuse. As inputs, Port A pins that are externally pulled low will source current if the pull-up resistors are activated. The Port A pins are tri-stated when a reset condition becomes active, even if the clock is not running.

Port A has an alternate functions as analog inputs for the ADC, analog comparator, timer/counter, SPI and pin change interrupt as described in [“Alternate Port Functions” on page 69](#).

1.1.4 $\overline{\text{RESET}}$

Reset input. A low level on this pin for longer than the minimum pulse length will generate a reset, even if the clock is not running. The minimum pulse length is given in [Table 20-4 on page 161](#). Shorter pulses are not guaranteed to generate a reset.

1.1.5 Port B (PB7:PB0)

Port B is a 8-bit bi-directional I/O port with internal pull-up resistors (selected for each bit). The Port B output buffers have symmetrical drive characteristics with both high sink and source capability. As inputs, Port B pins that are externally pulled low will source current if the pull-up resistors are activated. The Port B pins are tri-stated when a reset condition becomes active, even if the clock is not running.

Port B also serves the functions of various special features as listed in [Section 11.3 “Alternate Port Functions” on page 69](#).

1.1.6 LSW

Boost converter external inductor connection. Connect to ground when boost converter is disabled permanently.

1.1.7 V_{BAT}

Battery supply voltage. Connect to ground when boost converter is disabled permanently.

2. Overview

The ATtiny43U is a low-power CMOS 8-bit microcontroller based on the AVR enhanced RISC architecture. By executing powerful instructions in a single clock cycle, the ATtiny43U achieves throughputs approaching 1 MIPS per MHz allowing the system designer to optimize power consumption versus processing speed.

Figure 2-1. Block Diagram

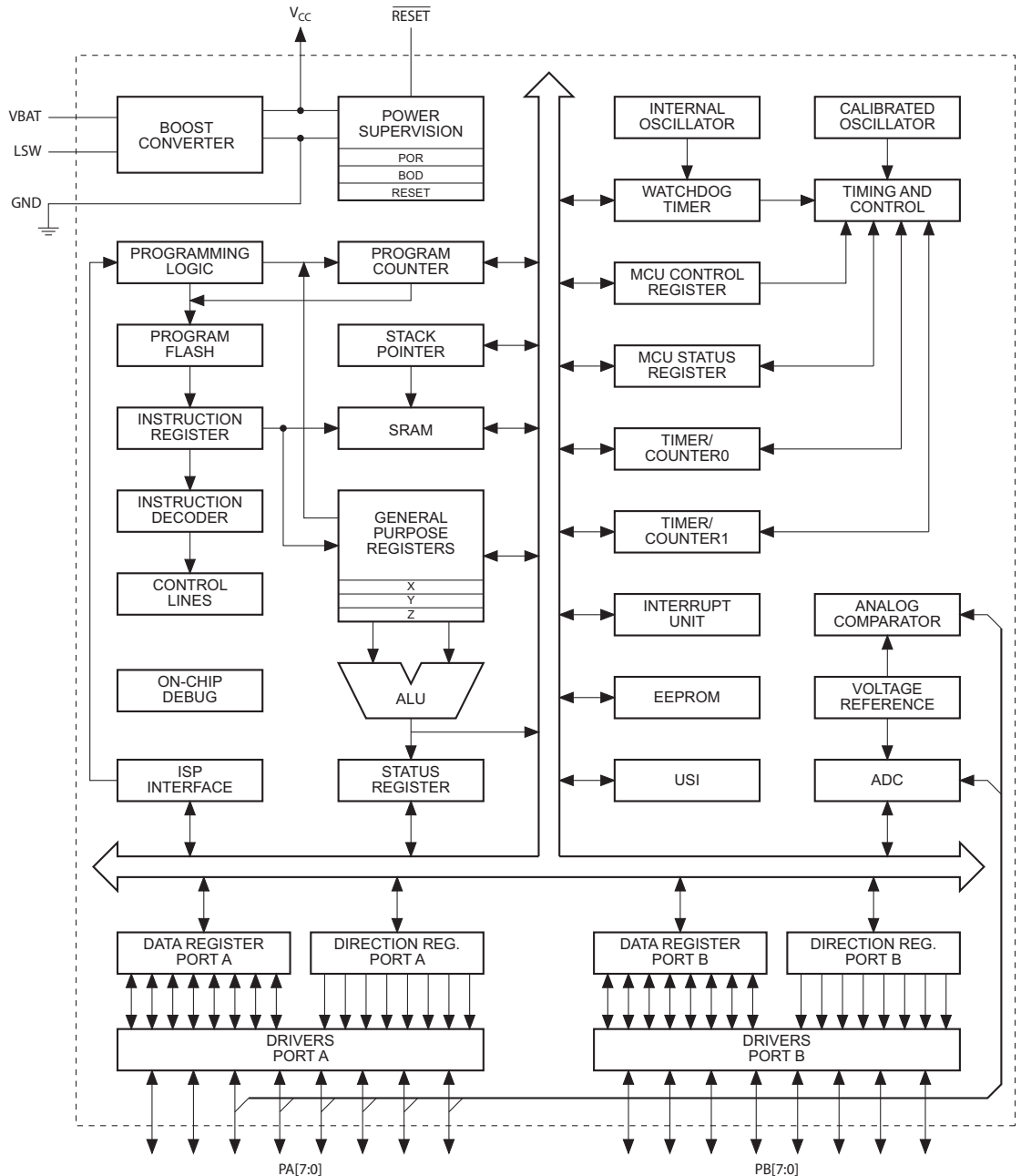

The AVR core combines a rich instruction set with 32 general purpose working registers. All the 32 registers are directly connected to the Arithmetic Logic Unit (ALU), allowing two independent registers to be accessed in one single instruction executed in one clock cycle. The resulting

architecture is more code efficient while achieving throughputs up to ten times faster than conventional CISC microcontrollers.

The ATtiny43U provides the following features: 4K byte of In-System Programmable Flash, 64 bytes EEPROM, 256 bytes SRAM, 16 general purpose I/O lines, 32 general purpose working registers, two 8-bit Timer/Counters with two PWM channels, Internal and External Interrupts, a 4-channel 10-bit ADC, Universal Serial Interface, a programmable Watchdog Timer with internal Oscillator, internal calibrated oscillator, and three software selectable power saving modes. The Idle mode stops the CPU while allowing the SRAM, Timer/Counter, ADC, Analog Comparator, and Interrupt system to continue functioning. The Power-down mode saves the register contents, disabling all chip functions until the next Interrupt or Hardware Reset. The ADC Noise Reduction mode stops the CPU and all I/O modules except ADC, to minimize switching noise during ADC conversions.

A special feature of ATtiny43U is the built-in boost voltage converter, which provides 3V supply voltage from an external, low voltage.

The device is manufactured using Atmel's high density non-volatile memory technology. The On-chip ISP Flash allows the Program memory to be re-programmed In-System through an SPI serial interface, by a conventional non-volatile memory programmer or by an On-chip boot code running on the AVR core.

The ATtiny43U AVR is supported by a full suite of program and system development tools including: C Compilers, Macro Assemblers, Program Debugger/Simulators, In-Circuit Emulators, and Evaluation kits.

3. General Information

3.1 Resources

A comprehensive set of development tools, drivers and application notes, and datasheets are available for download on <http://www.atmel.com/avr>.

3.2 Code Examples

This documentation contains simple code examples that briefly show how to use various parts of the device. These code examples assume that the part specific header file is included before compilation. Be aware that not all C compiler vendors include bit definitions in the header files and interrupt handling in C is compiler dependent. Please confirm with the C compiler documentation for more details.

For I/O Registers located in extended I/O map, “IN”, “OUT”, “SBIS”, “SBIC”, “CBI”, and “SBI” instructions must be replaced with instructions that allow access to extended I/O. Typically “LDS” and “STS” combined with “SBRS”, “SBRC”, “SBR”, and “CBR”.

3.3 Capacitive Touch Sensing

Atmel QTouch Library provides a simple to use solution for touch sensitive interfaces on Atmel AVR microcontrollers. The QTouch Library includes support for QTouch[®] and QMatrix[®] acquisition methods.

Touch sensing is easily added to any application by linking the QTouch Library and using the Application Programming Interface (API) of the library to define the touch channels and sensors. The application then calls the API to retrieve channel information and determine the state of the touch sensor.

The QTouch Library is free and can be downloaded from the Atmel website. For more information and details of implementation, refer to the QTouch Library User Guide – also available from the Atmel website.

3.4 Data Retention

Reliability Qualification results show that the projected data retention failure rate is much less than 1 PPM over 20 years at 85°C or 100 years at 25°C.

4. Register Summary

Address	Name	Bit 7	Bit 6	Bit 5	Bit 4	Bit 3	Bit 2	Bit 1	Bit 0	Page
0x3F (0x5F)	SREG	I	T	H	S	V	N	Z	C	Page 9
0x3E (0x5E)	SPH	–	–	–	–	–	–	–	SP8	Page 12
0x3D (0x5D)	SPL	SP7	SP6	SP5	SP4	SP3	SP2	SP1	SP0	Page 12
0x3C (0x5C)	OCR0B	Timer/Counter0 – Output Compare Register B								Page 97
0x3B (0x5B)	GIMSK	–	INT0	PCIE1	PCIE0	–	–	–	–	Page 61
0x3A (0x5A)	GIFR	–	INTF0	PCIF1	PCIF0	–	–	–	–	Page 61
0x39 (0x59)	TIMSK0	–	–	–	–	–	OCIE0B	OCIE0A	TOIE0	Page 97
0x38 (0x58)	TIFR0	–	–	–	–	–	OCF0B	OCF0A	TOV0	Page 98
0x37 (0x57)	SPMCSR	–	–	–	CTPB	RFLB	PGWRT	PGERS	SPMEN	Page 139
0x36 (0x56)	OCR0A	Timer/Counter0 – Output Compare Register A								Page 97
0x35 (0x55)	MCUCR	BODS	PUD	SE	SM1	SM0	BODSE	ISC01	ISC00	Pages 33, 60, 79
0x34 (0x54)	MCUSR	–	–	–	–	WDRF	BORF	EXTRF	PORF	Page 55
0x33 (0x53)	TCCR0B	FOC0A	FOC0B	–	–	WGM02	CS02	CS01	CS00	Page 95
0x32 (0x52)	TCNT0	Timer/Counter0								Page 96
0x31 (0x51)	OSCCAL	CAL7	CAL6	CAL5	CAL4	CAL3	CAL2	CAL1	CAL0	Page 28
0x30 (0x50)	TCCR0A	COM0A1	COM0A0	COM0B1	COM0B0	–	–	WGM01	WGM00	Page 92
0x2F (0x4F)	TCCR1A	COM1A1	COM1A0	COM1B1	COM1B0	–	–	WGM11	WGM10	Page 92
0x2E (0x4E)	TCCR1B	FOC1A	FOC1B	–	–	WGM12	CS12	CS11	CS10	Page 95
0x2D (0x4D)	TCNT1	Timer/Counter1								Page 97
0x2C (0x4C)	OCR1A	Timer/Counter1 – Output Compare Register A								Page 97
0x2B (0x4B)	OCR1B	Timer/Counter1 – Output Compare Register B								Page 97
0x2A (0x4A)	Reserved	–								
0x29 (0x49)	Reserved	–								
0x28 (0x48)	Reserved	–								
0x27 (0x47)	DWDR	DWDR[7:0]								Page 134
0x26 (0x46)	CLKPR	CLKPCE	–	–	–	CLKPS3	CLKPS2	CLKPS1	CLKPS0	Page 28
0x25 (0x45)	Reserved	–								
0x24 (0x44)	Reserved	–								
0x23 (0x43)	GTCCR	TSM	–	–	–	–	–	–	PSR10	Page 101
0x22 (0x42)	Reserved	–								
0x21 (0x41)	WDTCR	WDIF	WDIE	WDP3	WDCE	WDE	WDP2	WDP1	WDP0	Page 55
0x20 (0x40)	PCMSK1	PCINT15	PCINT14	PCINT13	PCINT12	PCINT11	PCINT10	PCINT9	PCINT8	Page 62
0x1F (0x3F)	Reserved	–								
0x1E (0x3E)	EEAR	–	–	EEAR5	EEAR4	EEAR3	EEAR2	EEAR1	EEAR0	Page 20
0x1D (0x3D)	EEDR	EEPROM Data Register								Page 21
0x1C (0x3C)	EEDR	–	–	EEDR5	EEDR4	EEDR3	EEDR2	EEDR1	EEDR0	Page 21
0x1B (0x3B)	PORTA	PORTA7	PORTA6	PORTA5	PORTA4	PORTA3	PORTA2	PORTA1	PORTA0	Page 79
0x1A (0x3A)	DDRA	DDA7	DDA6	DDA5	DDA4	DDA3	DDA2	DDA1	DDA0	Page 79
0x19 (0x39)	PINA	PINA7	PINA6	PINA5	PINA4	PINA3	PINA2	PINA1	PINA0	Page 79
0x18 (0x38)	PORTB	PORTB7	PORTB6	PORTB5	PORTB4	PORTB3	PORTB2	PORTB1	PORTB0	Page 79
0x17 (0x37)	DDRB	ddb7	ddb6	ddb5	ddb4	ddb3	ddb2	ddb1	ddb0	Page 79
0x16 (0x36)	PINB	PINB7	PINB6	PINB5	PINB4	PINB3	PINB2	PINB1	PINB0	Page 79
0x15 (0x35)	GPOR2	General Purpose I/O Register 2								Page 22
0x14 (0x34)	GPOR1	General Purpose I/O Register 1								Page 22
0x13 (0x33)	GPOR0	General Purpose I/O Register 0								Page 22
0x12 (0x32)	PCMSK0	PCINT7	PCINT6	PCINT5	PCINT4	PCINT3	PCINT2	PCINT1	PCINT0	Page 62
0x11 (0x31)	Reserved	–								
0x10 (0x30)	USIBR	USI Buffer Register								Page 113
0x0F (0x2F)	USIDR	USI Data Register								Page 112
0x0E (0x2E)	USISR	USISIF	USIOIF	USIPF	USIDC	USICNT3	USICNT2	USICNT1	USICNT0	Page 111
0x0D (0x2D)	USICR	USISIE	USIOIE	USIWM1	USIWM0	USICS1	USICS0	USICLK	USITC	Page 109
0x0C (0x2C)	TIMSK1	–	–	–	–	–	OCIE1B	OCIE1A	TOIE1	Page 98
0x0B (0x2B)	TIFR1	–	–	–	–	–	OCF1B	OCF1A	TOV1	Page 98
0x0A (0x2A)	Reserved	–								
0x09 (0x29)	Reserved	–								
0x08 (0x28)	ACSR	ACD	ACBG	ACO	ACI	ACIE	–	ACIS1	ACIS0	Page 115
0x07 (0x27)	ADMUX	–	REFS	–	–	–	MUX2	MUX1	MUX0	Page 128
0x06 (0x26)	ADCSRA	ADEN	ADSC	ADATE	ADIF	ADIE	ADPS2	ADPS1	ADPS0	Page 129
0x05 (0x25)	ADCH	ADC Data Register High Byte								Page 130
0x04 (0x24)	ADCL	ADC Data Register Low Byte								Page 130
0x03 (0x23)	ADCSRB	BS	ACME	–	ADLAR	–	ADTS2	ADTS1	ADTS0	Pages 48, 115, 131
0x02 (0x22)	Reserved	–								
0x01 (0x21)	DIDR0	–	–	AIN1D	AIN0D	ADC3D	ADC2D	ADC1D	ADC0D	Pages 116, 132
0x00 (0x20)	PRR	PRE2	PRE1	PRE0	–	PRTIM1	PRTIM0	PRUSI	PRADC	Page 34

- Note:
1. For compatibility with future devices, reserved bits should be written to zero if accessed. Reserved I/O memory addresses should never be written.
 2. I/O Registers within the address range 0x00 - 0x1F are directly bit-accessible using the SBI and CBI instructions. In these registers, the value of single bits can be checked by using the SBIS and SBIC instructions.
 3. Some of the Status Flags are cleared by writing a logical one to them. Note that, unlike most other AVR's, the CBI and SBI instructions will only operation the specified bit, and can therefore be used on registers containing such Status Flags. The CBI and SBI instructions work with registers 0x00 to 0x1F only.

5. Instruction Set Summary

Mnemonics	Operands	Description	Operation	Flags	#Clocks
ARITHMETIC AND LOGIC INSTRUCTIONS					
ADD	Rd, Rr	Add two Registers	$Rd \leftarrow Rd + Rr$	Z,C,N,V,H	1
ADC	Rd, Rr	Add with Carry two Registers	$Rd \leftarrow Rd + Rr + C$	Z,C,N,V,H	1
ADIW	Rd,K	Add Immediate to Word	$Rdh:Rdl \leftarrow Rdh:Rdl + K$	Z,C,N,V,S	2
SUB	Rd, Rr	Subtract two Registers	$Rd \leftarrow Rd - Rr$	Z,C,N,V,H	1
SUBI	Rd, K	Subtract Constant from Register	$Rd \leftarrow Rd - K$	Z,C,N,V,H	1
SBC	Rd, Rr	Subtract with Carry two Registers	$Rd \leftarrow Rd - Rr - C$	Z,C,N,V,H	1
SBCI	Rd, K	Subtract with Carry Constant from Reg.	$Rd \leftarrow Rd - K - C$	Z,C,N,V,H	1
SBIW	Rd,K	Subtract Immediate from Word	$Rdh:Rdl \leftarrow Rdh:Rdl - K$	Z,C,N,V,S	2
AND	Rd, Rr	Logical AND Registers	$Rd \leftarrow Rd \bullet Rr$	Z,N,V	1
ANDI	Rd, K	Logical AND Register and Constant	$Rd \leftarrow Rd \bullet K$	Z,N,V	1
OR	Rd, Rr	Logical OR Registers	$Rd \leftarrow Rd \vee Rr$	Z,N,V	1
ORI	Rd, K	Logical OR Register and Constant	$Rd \leftarrow Rd \vee K$	Z,N,V	1
EOR	Rd, Rr	Exclusive OR Registers	$Rd \leftarrow Rd \oplus Rr$	Z,N,V	1
COM	Rd	One's Complement	$Rd \leftarrow 0xFF - Rd$	Z,C,N,V	1
NEG	Rd	Two's Complement	$Rd \leftarrow 0x00 - Rd$	Z,C,N,V,H	1
SBR	Rd,K	Set Bit(s) in Register	$Rd \leftarrow Rd \vee K$	Z,N,V	1
CBR	Rd,K	Clear Bit(s) in Register	$Rd \leftarrow Rd \bullet (0xFF - K)$	Z,N,V	1
INC	Rd	Increment	$Rd \leftarrow Rd + 1$	Z,N,V	1
DEC	Rd	Decrement	$Rd \leftarrow Rd - 1$	Z,N,V	1
TST	Rd	Test for Zero or Minus	$Rd \leftarrow Rd \bullet Rd$	Z,N,V	1
CLR	Rd	Clear Register	$Rd \leftarrow Rd \oplus Rd$	Z,N,V	1
SER	Rd	Set Register	$Rd \leftarrow 0xFF$	None	1
BRANCH INSTRUCTIONS					
RJMP	k	Relative Jump	$PC \leftarrow PC + k + 1$	None	2
IJMP		Indirect Jump to (Z)	$PC \leftarrow Z$	None	2
RCALL	k	Relative Subroutine Call	$PC \leftarrow PC + k + 1$	None	3
ICALL		Indirect Call to (Z)	$PC \leftarrow Z$	None	3
RET		Subroutine Return	$PC \leftarrow STACK$	None	4
RETI		Interrupt Return	$PC \leftarrow STACK$	I	4
CPSE	Rd,Rr	Compare, Skip if Equal	if (Rd = Rr) $PC \leftarrow PC + 2$ or 3	None	1/2/3
CP	Rd,Rr	Compare	$Rd - Rr$	Z, N,V,C,H	1
CPC	Rd,Rr	Compare with Carry	$Rd - Rr - C$	Z, N,V,C,H	1
CPI	Rd,K	Compare Register with Immediate	$Rd - K$	Z, N,V,C,H	1
SBRC	Rr, b	Skip if Bit in Register Cleared	if (Rr(b)=0) $PC \leftarrow PC + 2$ or 3	None	1/2/3
SBRS	Rr, b	Skip if Bit in Register is Set	if (Rr(b)=1) $PC \leftarrow PC + 2$ or 3	None	1/2/3
SBIC	P, b	Skip if Bit in I/O Register Cleared	if (P(b)=0) $PC \leftarrow PC + 2$ or 3	None	1/2/3
SBIS	P, b	Skip if Bit in I/O Register is Set	if (P(b)=1) $PC \leftarrow PC + 2$ or 3	None	1/2/3
BRBS	s, k	Branch if Status Flag Set	if (SREG(s) = 1) then $PC \leftarrow PC + k + 1$	None	1/2
BRBC	s, k	Branch if Status Flag Cleared	if (SREG(s) = 0) then $PC \leftarrow PC + k + 1$	None	1/2
BREQ	k	Branch if Equal	if (Z = 1) then $PC \leftarrow PC + k + 1$	None	1/2
BRNE	k	Branch if Not Equal	if (Z = 0) then $PC \leftarrow PC + k + 1$	None	1/2
BRCS	k	Branch if Carry Set	if (C = 1) then $PC \leftarrow PC + k + 1$	None	1/2
BRCC	k	Branch if Carry Cleared	if (C = 0) then $PC \leftarrow PC + k + 1$	None	1/2
BRSH	k	Branch if Same or Higher	if (C = 0) then $PC \leftarrow PC + k + 1$	None	1/2
BRLO	k	Branch if Lower	if (C = 1) then $PC \leftarrow PC + k + 1$	None	1/2
BRMI	k	Branch if Minus	if (N = 1) then $PC \leftarrow PC + k + 1$	None	1/2
BRPL	k	Branch if Plus	if (N = 0) then $PC \leftarrow PC + k + 1$	None	1/2
BRGE	k	Branch if Greater or Equal, Signed	if (N \oplus V = 0) then $PC \leftarrow PC + k + 1$	None	1/2
BRLT	k	Branch if Less Than Zero, Signed	if (N \oplus V = 1) then $PC \leftarrow PC + k + 1$	None	1/2
BRHS	k	Branch if Half Carry Flag Set	if (H = 1) then $PC \leftarrow PC + k + 1$	None	1/2
BRHC	k	Branch if Half Carry Flag Cleared	if (H = 0) then $PC \leftarrow PC + k + 1$	None	1/2
BRTS	k	Branch if T Flag Set	if (T = 1) then $PC \leftarrow PC + k + 1$	None	1/2
BRTC	k	Branch if T Flag Cleared	if (T = 0) then $PC \leftarrow PC + k + 1$	None	1/2
BRVS	k	Branch if Overflow Flag is Set	if (V = 1) then $PC \leftarrow PC + k + 1$	None	1/2
BRVC	k	Branch if Overflow Flag is Cleared	if (V = 0) then $PC \leftarrow PC + k + 1$	None	1/2
BRIE	k	Branch if Interrupt Enabled	if (I = 1) then $PC \leftarrow PC + k + 1$	None	1/2
BRID	k	Branch if Interrupt Disabled	if (I = 0) then $PC \leftarrow PC + k + 1$	None	1/2
BIT AND BIT-TEST INSTRUCTIONS					
SBI	P,b	Set Bit in I/O Register	$I/O(P,b) \leftarrow 1$	None	2
CBI	P,b	Clear Bit in I/O Register	$I/O(P,b) \leftarrow 0$	None	2
LSL	Rd	Logical Shift Left	$Rd(n+1) \leftarrow Rd(n), Rd(0) \leftarrow 0$	Z,C,N,V	1
LSR	Rd	Logical Shift Right	$Rd(n) \leftarrow Rd(n+1), Rd(7) \leftarrow 0$	Z,C,N,V	1
ROL	Rd	Rotate Left Through Carry	$Rd(0) \leftarrow C, Rd(n+1) \leftarrow Rd(n), C \leftarrow Rd(7)$	Z,C,N,V	1

Mnemonics	Operands	Description	Operation	Flags	#Clocks
ROR	Rd	Rotate Right Through Carry	$Rd(7) \leftarrow C, Rd(n) \leftarrow Rd(n+1), C \leftarrow Rd(0)$	Z,C,N,V	1
ASR	Rd	Arithmetic Shift Right	$Rd(n) \leftarrow Rd(n+1), n=0..6$	Z,C,N,V	1
SWAP	Rd	Swap Nibbles	$Rd(3..0) \leftarrow Rd(7..4), Rd(7..4) \leftarrow Rd(3..0)$	None	1
BSET	s	Flag Set	$SREG(s) \leftarrow 1$	SREG(s)	1
BCLR	s	Flag Clear	$SREG(s) \leftarrow 0$	SREG(s)	1
BST	Rr, b	Bit Store from Register to T	$T \leftarrow Rr(b)$	T	1
BLD	Rd, b	Bit load from T to Register	$Rd(b) \leftarrow T$	None	1
SEC		Set Carry	$C \leftarrow 1$	C	1
CLC		Clear Carry	$C \leftarrow 0$	C	1
SEN		Set Negative Flag	$N \leftarrow 1$	N	1
CLN		Clear Negative Flag	$N \leftarrow 0$	N	1
SEZ		Set Zero Flag	$Z \leftarrow 1$	Z	1
CLZ		Clear Zero Flag	$Z \leftarrow 0$	Z	1
SEI		Global Interrupt Enable	$I \leftarrow 1$	I	1
CLI		Global Interrupt Disable	$I \leftarrow 0$	I	1
SES		Set Signed Test Flag	$S \leftarrow 1$	S	1
CLS		Clear Signed Test Flag	$S \leftarrow 0$	S	1
SEV		Set Twos Complement Overflow	$V \leftarrow 1$	V	1
CLV		Clear Twos Complement Overflow	$V \leftarrow 0$	V	1
SET		Set T in SREG	$T \leftarrow 1$	T	1
CLT		Clear T in SREG	$T \leftarrow 0$	T	1
SEH		Set Half Carry Flag in SREG	$H \leftarrow 1$	H	1
CLH		Clear Half Carry Flag in SREG	$H \leftarrow 0$	H	1
DATA TRANSFER INSTRUCTIONS					
MOV	Rd, Rr	Move Between Registers	$Rd \leftarrow Rr$	None	1
MOVW	Rd, Rr	Copy Register Word	$Rd+1:Rd \leftarrow Rr+1:Rr$	None	1
LDI	Rd, K	Load Immediate	$Rd \leftarrow K$	None	1
LD	Rd, X	Load Indirect	$Rd \leftarrow (X)$	None	2
LD	Rd, X+	Load Indirect and Post-Inc.	$Rd \leftarrow (X), X \leftarrow X + 1$	None	2
LD	Rd, -X	Load Indirect and Pre-Dec.	$X \leftarrow X - 1, Rd \leftarrow (X)$	None	2
LD	Rd, Y	Load Indirect	$Rd \leftarrow (Y)$	None	2
LD	Rd, Y+	Load Indirect and Post-Inc.	$Rd \leftarrow (Y), Y \leftarrow Y + 1$	None	2
LD	Rd, -Y	Load Indirect and Pre-Dec.	$Y \leftarrow Y - 1, Rd \leftarrow (Y)$	None	2
LDD	Rd, Y+q	Load Indirect with Displacement	$Rd \leftarrow (Y + q)$	None	2
LD	Rd, Z	Load Indirect	$Rd \leftarrow (Z)$	None	2
LD	Rd, Z+	Load Indirect and Post-Inc.	$Rd \leftarrow (Z), Z \leftarrow Z + 1$	None	2
LD	Rd, -Z	Load Indirect and Pre-Dec.	$Z \leftarrow Z - 1, Rd \leftarrow (Z)$	None	2
LDD	Rd, Z+q	Load Indirect with Displacement	$Rd \leftarrow (Z + q)$	None	2
LDS	Rd, k	Load Direct from SRAM	$Rd \leftarrow (k)$	None	2
ST	X, Rr	Store Indirect	$(X) \leftarrow Rr$	None	2
ST	X+, Rr	Store Indirect and Post-Inc.	$(X) \leftarrow Rr, X \leftarrow X + 1$	None	2
ST	-X, Rr	Store Indirect and Pre-Dec.	$X \leftarrow X - 1, (X) \leftarrow Rr$	None	2
ST	Y, Rr	Store Indirect	$(Y) \leftarrow Rr$	None	2
ST	Y+, Rr	Store Indirect and Post-Inc.	$(Y) \leftarrow Rr, Y \leftarrow Y + 1$	None	2
ST	-Y, Rr	Store Indirect and Pre-Dec.	$Y \leftarrow Y - 1, (Y) \leftarrow Rr$	None	2
STD	Y+q, Rr	Store Indirect with Displacement	$(Y + q) \leftarrow Rr$	None	2
ST	Z, Rr	Store Indirect	$(Z) \leftarrow Rr$	None	2
ST	Z+, Rr	Store Indirect and Post-Inc.	$(Z) \leftarrow Rr, Z \leftarrow Z + 1$	None	2
ST	-Z, Rr	Store Indirect and Pre-Dec.	$Z \leftarrow Z - 1, (Z) \leftarrow Rr$	None	2
STD	Z+q, Rr	Store Indirect with Displacement	$(Z + q) \leftarrow Rr$	None	2
STS	k, Rr	Store Direct to SRAM	$(k) \leftarrow Rr$	None	2
LPM		Load Program Memory	$R0 \leftarrow (Z)$	None	3
LPM	Rd, Z	Load Program Memory	$Rd \leftarrow (Z)$	None	3
LPM	Rd, Z+	Load Program Memory and Post-Inc	$Rd \leftarrow (Z), Z \leftarrow Z + 1$	None	3
SPM		Store Program Memory	$(z) \leftarrow R1:R0$	None	
IN	Rd, P	In Port	$Rd \leftarrow P$	None	1
OUT	P, Rr	Out Port	$P \leftarrow Rr$	None	1
PUSH	Rr	Push Register on Stack	$STACK \leftarrow Rr$	None	2
POP	Rd	Pop Register from Stack	$Rd \leftarrow STACK$	None	2
MCU CONTROL INSTRUCTIONS					
NOP		No Operation		None	1
SLEEP		Sleep	(see specific descr. for Sleep function)	None	1
WDR		Watchdog Reset	(see specific descr. for WDR/Timer)	None	1
BREAK		Break	For On-chip Debug Only	None	N/A

6. Ordering Information

6.1 ATtiny43U

Speed	Supply Voltage	Temperature Range	Package ⁽¹⁾	Ordering Code ⁽²⁾
8 MHz	1.8 - 5.5V ⁽³⁾	Industrial (-40°C to 85°C)	20M1	ATtiny43U-MU
				ATtiny43U-MUR
			20S2	ATtiny43U-SU
				ATtiny43U-SUR

Notes: 1. All packages are Pb-free, halide-free and fully green and they comply with the European directive for Restriction of Hazardous Substances (RoHS).

2. Code indicators:

– U, N or F: matte tin

– R: tape & reel

3. Supply voltage on V_{CC} pin, boost converter disregarded. When boost converter is active the device can be operated from voltages sources lower than indicated here. See table “Characteristics of Boost Converter. T = -20°C to +85°C, unless otherwise noted” on page 162 for more information.

Package Type	
20M1	20-pad, 4 x 4 x 0.8 mm Body, Quad Flat No-Lead/Micro Lead Frame Package (QFN/MLF)
20S2	20-lead, 0.300" Wide Body, Plastic Gull Wing Small Outline Package (SOIC)

7. Packaging Information

7.1 20M1

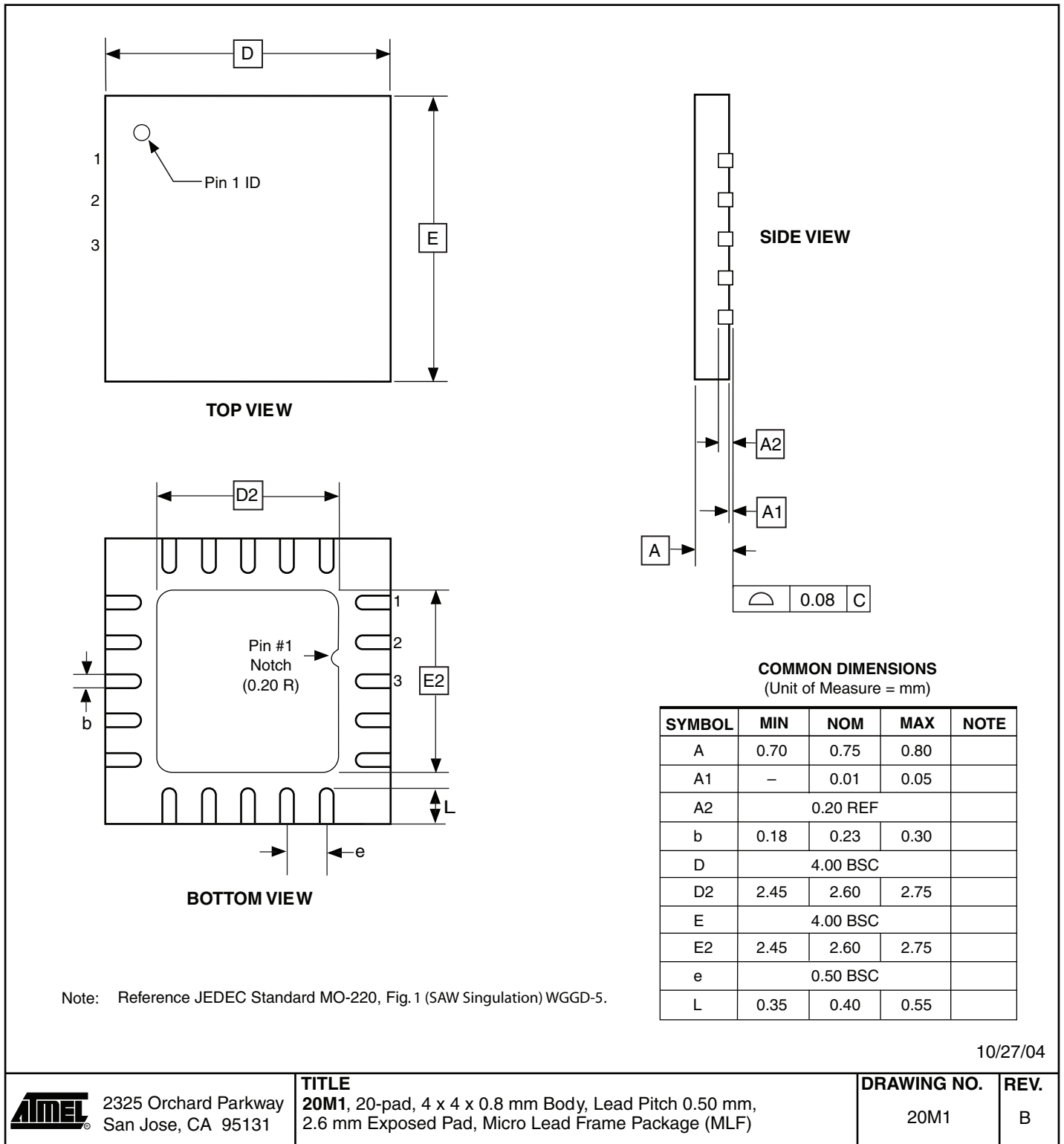

10/27/04



2325 Orchard Parkway
San Jose, CA 95131

TITLE

20M1, 20-pad, 4 x 4 x 0.8 mm Body, Lead Pitch 0.50 mm,
2.6 mm Exposed Pad, Micro Lead Frame Package (MLF)

DRAWING NO.

20M1

REV.

B

7.2 20S2

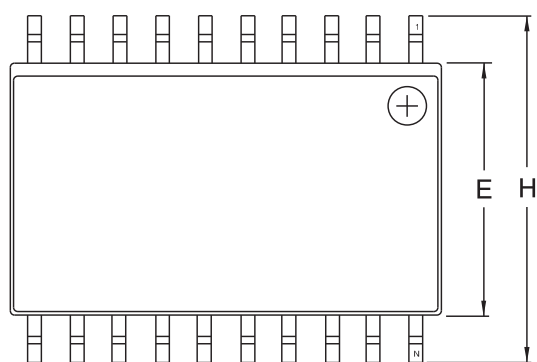

Top View

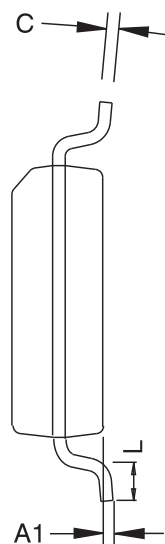

End View

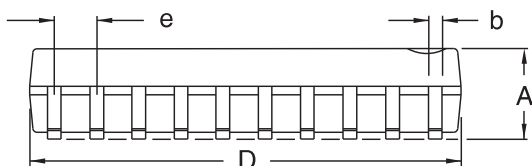

Side View

COMMON DIMENSIONS
(Unit of Measure – mm)

SYMBOL	MIN	NOM	MAX	NOTE
A	2.35		2.65	
A1	0.10		0.30	
b	0.33		0.51	4
C	0.23		0.32	
D	12.60		13.00	1
E	7.40		7.60	2
H	10.00		10.65	
L	0.40		1.27	3
e	1.27 BSC			

- Notes.
1. This drawing is for general information only; refer to JEDEC Drawing MS-013, Variation AC for additional information.
 2. Dimension 'D' does not include mold Flash, protrusions or gate burrs. Mold Flash, protrusions and gate burrs shall not exceed 0.15 mm (0.006") per side.
 3. Dimension 'E' does not include inter-lead Flash or protrusion. Inter-lead Flash and protrusions shall not exceed 0.25 mm (0.010") per side.
 4. 'L' is the length of the terminal for soldering to a substrate.
 5. The lead width 'b', as measured 0.36 mm (0.014") or greater above the seating plane, shall not exceed a maximum value of 0.61 mm (0.024") per side.

ATMEL 2325 Orchard Parkway
San Jose, CA 95131

TITLE
20S2, 20-lead, 0.300" Wide Body, Plastic Gull
Wing Small Outline Package (SOIC)

DRAWING NO.
20S2

REV.
B

8. Errata

The revision letter in this section refers to the revision of the ATtiny43U device.

8.1 ATtiny43U

8.1.1 Rev. D – F

No known errata.

8.1.2 Rev. C

- **Increased Probability of Boost Converter Entering Active Low Current Mode**

1. **Increased Probability Of Boost Converter Entering Active Low Current Mode**

The boost converter may enter and stay in Active Low Current Mode at supply voltages and load currents higher than those specified. This is due to high switching currents in bonding wires of the SOIC package. Devices packaged in MLF are not affected.

Problem Fix / Workaround

Add a 1.5nF capacitor between pins LSW and GND of the SOIC package. Also, increase the value of the by-pass capacitor between pins V_{CC} and GND to at least 30 μ F.

Alternatively, use the device in MLF, without modifications.

8.1.3 Rev. B – A

Not sampled.

9. Datasheet Revision History

9.1 Rev. 8048C – 02/12

1. Removed preliminary status of device.
2. Updated boost converter descriptions:
 - Last chapter of [Section 8.1 “Overview”](#) on page 35
 - Second chapter of [Section 8.6.4 “RC Filter”](#) on page 44
 - Boost Converter Component values in [Table 8-1](#) on page 45
 - Last chapter of [Section 9.2.3 “Brown-out Detection”](#) on page 51
 - DC Current from Boost Converter Output in [Section 20.1 “Absolute Maximum Ratings*”](#) on page 158
 - [Section 20.7 “Boost Converter Characteristics”](#) on page 162
 - [Section 20.8 “ADC Characteristics”](#) on page 164
 - [Section 21.1 “Boost Converter”](#) on page 168
3. Updated:
 - [Section “Features”](#) on page 1
 - [Section 16.8 “Analog Input Circuitry”](#) on page 124
 - [Table 16-4](#) on page 129
 - [Section 19.7.1 “Serial Programming Algorithm”](#) on page 154
 - [Section 20.2 “DC Characteristics”](#) on page 158
 - [Section 21. “Typical Characteristics”](#) on page 168
 - Bit syntax throughout the datasheet, e.g. from CSn2:0 to CSn[2:0]
4. Added:
 - [Section 3.3 “Capacitive Touch Sensing”](#) on page 6
 - Description on reset in [Section 8.5.1 “Stopping the Boost Converter”](#) on page 41
 - [Section 8.10 “Firmware Example”](#) on page 46
 - Characteristic plots in [Section 21. “Typical Characteristics”](#) , starting on page 170
 - Tape & reel in [Section 6. “Ordering Information”](#) on page 11

9.2 Rev. 8048B – 05/09

1. Updated bullet on data retention in [“Features”](#) on page 1.
2. Removed section [“Typical Applications”](#) on page 46. This data can now be found in application note AVR188.

9.3 Rev. 8048A – 02/09

Initial revision.



Headquarters

Atmel Corporation

2325 Orchard Parkway
San Jose, CA 95131
USA
Tel: (+1)(408) 441-0311
Fax: (+1)(408) 487-2600

International

Atmel Asia Limited

Unit 01-5 & 16, 19F
BEA Tower, Millennium City 5
418 Kwun Tong Road
Kwun Tong, Kowloon
HONG KONG
Tel: (+852) 2245-6100
Fax: (+852) 2722-1369

Atmel Munich GmbH

Business Campus
Parking 4
D-85748 Garching b. Munich
GERMANY
Tel: (+49) 89-31970-0
Fax: (+49) 89-3194621

Atmel Japan

9F, Tonetsu Shinkawa Bldg.
1-24-8 Shinkawa
Chuo-ku, Tokyo 104-0033
JAPAN
Tel: (+81)(3) 3523-3551
Fax: (+81)(3) 3523-7581

Product Contact

Web Site

www.atmel.com

Technical Support

avr@atmel.com

Sales Contact

www.atmel.com/contacts

Literature Requests

www.atmel.com/literature

Disclaimer: The information in this document is provided in connection with Atmel products. No license, express or implied, by estoppel or otherwise, to any intellectual property right is granted by this document or in connection with the sale of Atmel products. **EXCEPT AS SET FORTH IN ATMEL'S TERMS AND CONDITIONS OF SALE LOCATED ON ATMEL'S WEB SITE, ATMEL ASSUMES NO LIABILITY WHATSOEVER AND DISCLAIMS ANY EXPRESS, IMPLIED OR STATUTORY WARRANTY RELATING TO ITS PRODUCTS INCLUDING, BUT NOT LIMITED TO, THE IMPLIED WARRANTY OF MERCHANTABILITY, FITNESS FOR A PARTICULAR PURPOSE, OR NON-INFRINGEMENT. IN NO EVENT SHALL ATMEL BE LIABLE FOR ANY DIRECT, INDIRECT, CONSEQUENTIAL, PUNITIVE, SPECIAL OR INCIDENTAL DAMAGES (INCLUDING, WITHOUT LIMITATION, DAMAGES FOR LOSS OF PROFITS, BUSINESS INTERRUPTION, OR LOSS OF INFORMATION) ARISING OUT OF THE USE OR INABILITY TO USE THIS DOCUMENT, EVEN IF ATMEL HAS BEEN ADVISED OF THE POSSIBILITY OF SUCH DAMAGES.** Atmel makes no representations or warranties with respect to the accuracy or completeness of the contents of this document and reserves the right to make changes to specifications and product descriptions at any time without notice. Atmel does not make any commitment to update the information contained herein. Unless specifically provided otherwise, Atmel products are not suitable for, and shall not be used in, automotive applications. Atmel's products are not intended, authorized, or warranted for use as components in applications intended to support or sustain life.

© 2012 Atmel Corporation. All rights reserved.

Atmel®, logo and combinations thereof, and others are registered trademarks or trademarks of Atmel Corporation or its subsidiaries. Other terms and product names may be trademarks of others.