

Features

- High Performance, Low Power AVR[®] 8-bit Microcontroller
- Advanced RISC Architecture
 - 131 Powerful Instructions - Most Single Clock Cycle Execution
 - 32 x 8 General Purpose Working Registers
 - Fully Static Operation
 - Up to 4 MIPS Throughput at 4 MHz
- High Endurance Non-volatile Memory segments
 - 8K/16K Bytes of In-System Self-Programmable Flash Program Memory(ATmega8HVA/16HVA)
 - 256 Bytes EEPROM
 - 512 Bytes Internal SRAM
 - Write/Erase cycles: 10,000 Flash/100,000 EEPROM
 - Data Retention: 20 years at 85°C /100 years at 25°C⁽¹⁾
 - Programming Lock for Software Security
- Battery Management Features
 - One or Two Cells in Series
 - Over-current Protection (Charge and Discharge)
 - Short-circuit Protection (Discharge)
 - High Voltage Outputs to Drive N-Channel Charge/Discharge FETs
- Peripheral Features
 - Two configurable 8- or 16-bit Timers with Separate Prescaler, Optional Input Capture (IC), Compare Mode and CTC
 - SPI - Serial Programmable Interface
 - 12-bit Voltage ADC, Four External and One Internal ADC Inputs
 - High Resolution Coulomb Counter ADC for Current Measurements
 - Programmable Watchdog Timer
- Special Microcontroller Features
 - debugWIRE On-chip Debug System
 - In-System Programmable via SPI ports
 - Power-on Reset
 - On-chip Voltage Regulator with Short-circuit Monitoring Interface
 - External and Internal Interrupt Sources
 - Sleep Modes:
Idle, ADC Noise Reduction, Power-save, and Power-off
- Additional Secure Authentication Features available only under NDA
- Packages
 - 36-pad LGA
 - 28-lead TSOP
- Operating Voltage: 1.8 - 9V
- Maximum Withstand Voltage (High-voltage pins): 28V
- Temperature Range: - 20°C to 85°C
- Speed Grade: 1-4 MHz



8-bit AVR[®] Microcontroller with 8K/16K Bytes In-System Programmable Flash

ATmega8HVA
ATmega16HVA

Preliminary

Summary



1. Pin Configurations

1.1 LGA

Figure 1-1. LGA - Pinout ATmega8HVA/16HVA

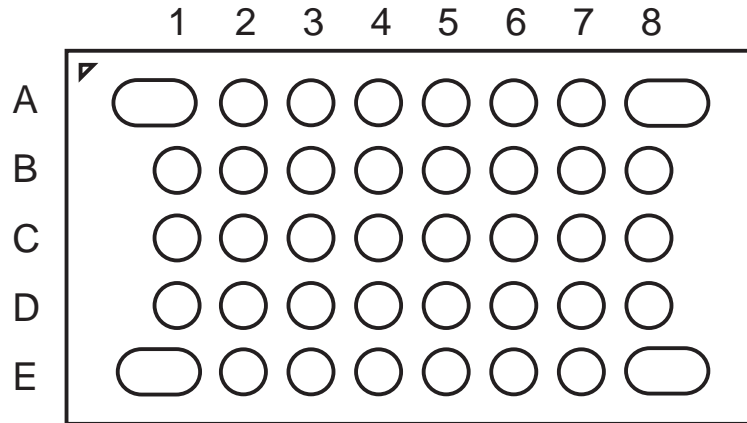
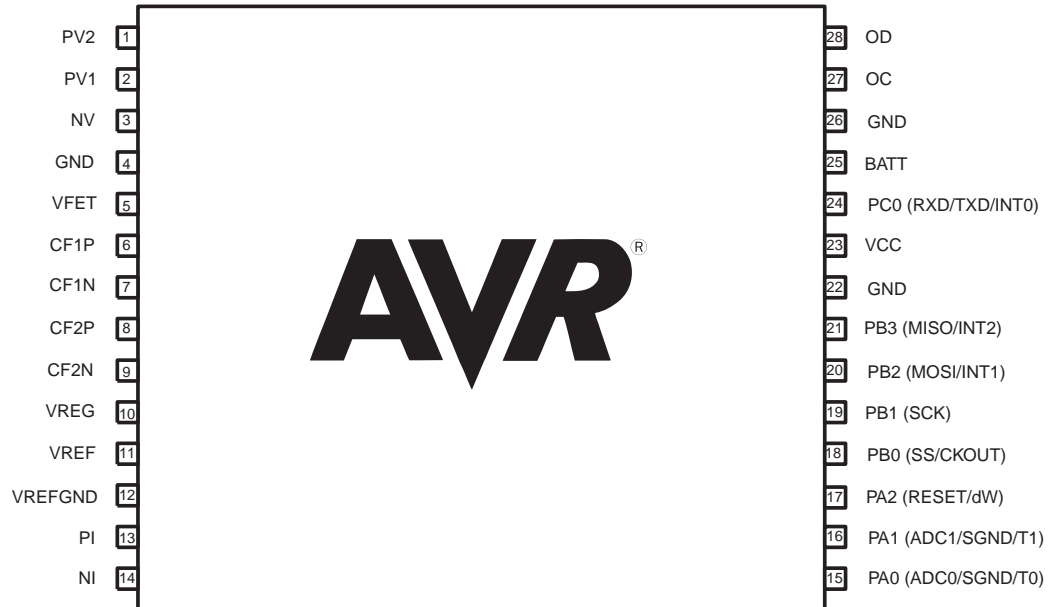

Figure 1-2. LGA - pinout ATmega8HVA/16HVA

	1	2	3	4	5	6	7	8
A	DNC	PV2	PV1	NV	GND	OC	OD	DNC
B	CF2P	CF2N	VFET	CF1P	GND	PC0	DNC	GND
C	VREF	VREFGND	VREG	CF1N	VCC	GND	GND	BATT
D	PI	NI	GND	GND	GND	PB2	PB3	GND
E	DNC	DNC	PA1	PA0	PB1	PB0	RESET	DNC

1.2 TSOP

Figure 1-3. TSOP - pinout ATmega8HVA/16HVA



1.3 Pin Descriptions

1.3.1 VFET

Input to the internal voltage regulator.

1.3.2 VCC

Digital supply voltage. Normally connected to VREG.

1.3.3 VREG

Output from the internal voltage regulator.

1.3.4 CF1P/CF1N/CF2P/CF2N

CF1P/CF1N/CF2P/CF2N are the connection pins for connecting external fly capacitors to the step-up regulator.

1.3.5 VREF

Internal Voltage Reference for external decoupling.

1.3.6 VREFGND

Ground for decoupling of Internal Voltage Reference. Do not connect to GND or SGND on PCB.

1.3.7 GND

Ground

1.3.8 Port A (PA1..PA0)

Port A serves as a low-voltage 2-bit bi-directional I/O port with internal pull-up resistors (selected for each bit). As inputs, Port A pins that are externally pulled low will source current if the pull-up resistors are activated. The Port A pins are tri-stated when a reset condition becomes active, even if the clock is not running.

Port A also serves the functions of various special features of the ATmega8HVA/16HVA as listed in ["Alternate Functions of Port A" on page 70](#).

1.3.9 Port B (PB3..PB0)

Port B is a low-voltage 4-bit bi-directional I/O port with internal pull-up resistors (selected for each bit). As inputs, Port B pins that are externally pulled low will source current if the pull-up resistors are activated. The Port B pins are tri-stated when a reset condition becomes active, even if the clock is not running.

Port B also serves the functions of various special features of the ATmega8HVA/16HVA as listed in ["Alternate Functions of Port B" on page 71](#).

1.3.10 PC0

Port C serves the functions of various special features of the ATmega8HVA/16HVA as listed in ["Alternate Functions of Port C" on page 61](#).

1.3.11 OC

High voltage output to drive Charge FET.

1.3.12 OD

High voltage output to drive Discharge FET.

1.3.13 NI

NI is the filtered negative input from the current sense resistor.

1.3.14 PI

PI is the filtered positive input from the current sense resistor.

1.3.15 NV/PV1/PV2

NV, PV1, and PV2 are the inputs for battery cells 1 and 2.

1.3.16 BATT

Input for detecting when a charger is connected.

1.3.17 $\overline{\text{RESET}}$ /dw

Reset input. A low level on this pin for longer than the minimum pulse length will generate a reset, even if the clock is not running. The minimum pulse length is given in Table 11 on page 38. Shorter pulses are not guaranteed to generate a reset. This pin is also used as debugWIRE communication pin.



The ATmega8HVA/16HVA contains a 12-bit ADC that can be used to measure the voltage of each cell individually. The ADC can also be used to monitor temperature, either on-chip temperature using the built-in temperature sensor, external temperature using thermistors connected to dedicated ADC inputs. The ATmega8HVA/16HVA contains a high-voltage tolerant, open-drain IO pin that supports serial communication. Programming can be done in-system using the 4 General Purpose IO ports that support SPI programming.

The AVR core combines a rich instruction set with 32 general purpose working registers. All the 32 registers are directly connected to the Arithmetic Logic Unit (ALU), allowing two independent registers to be accessed in one single instruction executed in one clock cycle. The resulting architecture is more code efficient while achieving throughputs up to ten times faster than conventional CISC microcontrollers.

The MCU includes 8K/16K bytes of In-System Programmable Flash with Read-While-Write capabilities, 256 bytes EEPROM, 512 bytes SRAM, 32 general purpose working registers, 6 general purpose I/O lines, debugWIRE for On-chip debugging and SPI for In-system Programming, two flexible Timer/Counters with Input Capture and compare modes, internal and external interrupts, a 12-bit Sigma Delta ADC for voltage and temperature measurements, a high resolution Sigma Delta ADC for Coulomb Counting and instantaneous current measurements, Additional Secure Authentication Features, an autonomous Battery Protection module, a programmable Watchdog Timer with wake-up capabilities, and software selectable power saving modes.

The AVR core combines a rich instruction set with 32 general purpose working registers. All the 32 registers are directly connected to the Arithmetic Logic Unit (ALU), allowing two independent registers to be accessed in one single instruction executed in one clock cycle. The resulting architecture is more code efficient while achieving throughputs up to ten times faster than conventional CISC microcontrollers.

The device is manufactured using Atmel's high voltage high density non-volatile memory technology. The On-chip ISP Flash allows the program memory to be reprogrammed In-System, through an SPI serial interface, by a conventional non-volatile memory programmer or by an On-chip Boot program running on the AVR core. By combining an 8-bit RISC CPU with In-System Self-Programmable Flash, fuel gauging ADCs, dedicated battery protection circuitry, and a voltage regulator on a monolithic chip, the ATmega8HVA/16HVA is a powerful microcontroller that provides a highly flexible and cost effective solution for Li-ion Smart Battery applications.

The ATmega8HVA/16HVA AVR is supported with a full suite of program and system development tools including: C Compilers, Macro Assemblers, Program Debugger/Simulators, and On-chip Debugger.

The ATmega8HVA/16HVA is a low-power CMOS 8-bit microcontroller based on the AVR architecture. It is part of the AVR Smart Battery family that provides secure authentication, highly accurate monitoring and autonomous protection for Lithium-ion battery cells.

2.1 Comparison Between ATmega8HVA and ATmega16HVA

The ATmega8HVA and ATmega16HVA differ only in memory size and interrupt vector size. [Table 2-1](#) summarizes the different configuration for the two devices.

Table 2-1. Configuration summary

Device	Flash	Interrupt vector size
ATmega8HVA	8K	1 Word
ATmega16HVA	16K	2 Word

3. Disclaimer

All Min, Typ and Max values contained in this datasheet are preliminary estimates based on simulations and characterization of other AVR microcontrollers manufactured on the same process technology. Final values will be available after the device is characterized.

4. Resources

A comprehensive set of development tools, application notes and datasheets are available for download on <http://www.atmel.com/avr>.

5. Data Retention

Reliability Qualification results show that the projected data retention failure rate is much less than 1 PPM over 20 years at 85°C or 100 years at 25°C.

6. Register Summary

Address	Name	Bit 7	Bit 6	Bit 5	Bit 4	Bit 3	Bit 2	Bit 1	Bit 0	Page
(0xFF)	Reserved	-	-	-	-	-	-	-	-	
(0xFE)	BPPLR	-	-	-	-	-	-	BPPLE	BPPL	127
(0xFD)	BPCR	-	-	-	SCD	DOCD	COCD	DHCD	CHCD	127
(0xFC)	BPHCTR	-	-	-	-	-	-	-	-	130
(0xFB)	BPOCTR	-	-	-	-	-	-	-	-	129
(0xFA)	BPSCTR	-	-	-	-	-	-	-	-	128
(0xF9)	BPCHCD	-	-	-	-	-	-	-	-	132
(0xF8)	BPDHCD	-	-	-	-	-	-	-	-	132
(0xF7)	BPCOCD	-	-	-	-	-	-	-	-	131
(0xF6)	BPDOCD	-	-	-	-	-	-	-	-	131
(0xF5)	BPSCD	-	-	-	-	-	-	-	-	131
(0xF4)	Reserved	-	-	-	-	-	-	-	-	
(0xF3)	BPIFR	-	-	-	SCIF	DOCIF	COCIF	DHCIF	CHCIF	134
(0xF2)	BPIMSK	-	-	-	SCIE	DOCIE	COCIE	DHCIE	CHCIE	133
(0xF1)	Reserved	-	-	-	-	-	-	-	-	
(0xF0)	FCSR	-	-	-	-	DUVRD	CPS	DFE	CFE	138
(0xEF)	Reserved	-	-	-	-	-	-	-	-	
(0xEE)	Reserved	-	-	-	-	-	-	-	-	
(0xED)	Reserved	-	-	-	-	-	-	-	-	
(0xEC)	Reserved	-	-	-	-	-	-	-	-	
(0xEB)	Reserved	-	-	-	-	-	-	-	-	
(0xEA)	Reserved	-	-	-	-	-	-	-	-	
(0xE9)	CADICH	-	-	-	-	-	-	-	-	110
(0xE8)	CADICL	-	-	-	-	-	-	-	-	110
(0xE7)	Reserved	-	-	-	-	-	-	-	-	
(0xE6)	CADRC	-	-	-	-	-	-	-	-	111
(0xE5)	CADCSRA	-	CADACIE	-	CADICIE	-	CADACIF	CADRCIF	CADICIF	109
(0xE4)	CADCSRA	CADEN	CADPOL	CADUB	-	CADAS[1:0]	-	CADS[1:0]	CADSE	107
(0xE3)	CADAC3	-	-	-	-	-	-	-	-	110
(0xE2)	CADAC2	-	-	-	-	-	-	-	-	110
(0xE1)	CADAC1	-	-	-	-	-	-	-	-	110
(0xE0)	CADAC0	-	-	-	-	-	-	-	-	110
(0xDF)	Reserved	-	-	-	-	-	-	-	-	
(0xDE)	Reserved	-	-	-	-	-	-	-	-	
(0xDD)	Reserved	-	-	-	-	-	-	-	-	
(0xDC)	Reserved	-	-	-	-	-	-	-	-	
(0xDB)	Reserved	-	-	-	-	-	-	-	-	
(0xDA)	Reserved	-	-	-	-	-	-	-	-	
(0xD9)	Reserved	-	-	-	-	-	-	-	-	
(0xD8)	Reserved	-	-	-	-	-	-	-	-	
(0xD7)	Reserved	-	-	-	-	-	-	-	-	
(0xD6)	Reserved	-	-	-	-	-	-	-	-	
(0xD5)	Reserved	-	-	-	-	-	-	-	-	
(0xD4)	Reserved	-	-	-	-	-	-	-	-	
(0xD3)	Reserved	-	-	-	-	-	-	-	-	
(0xD2)	Reserved	-	-	-	-	-	-	-	-	
(0xD1)	BGCR	-	-	-	-	-	-	-	-	119
(0xD0)	BGCCR	BGD	-	-	-	-	-	-	-	118
(0xCF)	Reserved	-	-	-	-	-	-	-	-	
(0xCE)	Reserved	-	-	-	-	-	-	-	-	
(0xCD)	Reserved	-	-	-	-	-	-	-	-	
(0xCC)	Reserved	-	-	-	-	-	-	-	-	
(0xCB)	Reserved	-	-	-	-	-	-	-	-	
(0xCA)	Reserved	-	-	-	-	-	-	-	-	
(0xC9)	Reserved	-	-	-	-	-	-	-	-	
(0xC8)	ROCR	ROCS	-	-	-	-	-	ROCWIF	ROCWIE	123
(0xC7)	Reserved	-	-	-	-	-	-	-	-	
(0xC6)	Reserved	-	-	-	-	-	-	-	-	
(0xC5)	Reserved	-	-	-	-	-	-	-	-	
(0xC4)	Reserved	-	-	-	-	-	-	-	-	
(0xC3)	Reserved	-	-	-	-	-	-	-	-	
(0xC2)	Reserved	-	-	-	-	-	-	-	-	
(0xC1)	Reserved	-	-	-	-	-	-	-	-	
(0xC0)	Reserved	-	-	-	-	-	-	-	-	

Address	Name	Bit 7	Bit 6	Bit 5	Bit 4	Bit 3	Bit 2	Bit 1	Bit 0	Page
(0xBF)	Reserved	-	-	-	-	-	-	-	-	
(0xBE)	Reserved	-	-	-	-	-	-	-	-	
(0xBD)	Reserved	-	-	-	-	-	-	-	-	
(0xBC)	Reserved	-	-	-	-	-	-	-	-	
(0xBB)	Reserved	-	-	-	-	-	-	-	-	
(0xBA)	Reserved	-	-	-	-	-	-	-	-	
(0xB9)	Reserved	-	-	-	-	-	-	-	-	
(0xB8)	Reserved	-	-	-	-	-	-	-	-	
(0xB7)	Reserved	-	-	-	-	-	-	-	-	
(0xB6)	Reserved	-	-	-	-	-	-	-	-	
(0xB5)	Reserved	-	-	-	-	-	-	-	-	
(0xB4)	Reserved	-	-	-	-	-	-	-	-	
(0xB3)	Reserved	-	-	-	-	-	-	-	-	
(0xB2)	Reserved	-	-	-	-	-	-	-	-	
(0xB1)	Reserved	-	-	-	-	-	-	-	-	
(0xB0)	Reserved	-	-	-	-	-	-	-	-	
(0xAF)	Reserved	-	-	-	-	-	-	-	-	
(0xAE)	Reserved	-	-	-	-	-	-	-	-	
(0xAD)	Reserved	-	-	-	-	-	-	-	-	
(0xAC)	Reserved	-	-	-	-	-	-	-	-	
(0xAB)	Reserved	-	-	-	-	-	-	-	-	
(0xAA)	Reserved	-	-	-	-	-	-	-	-	
(0xA9)	Reserved	-	-	-	-	-	-	-	-	
(0xA8)	Reserved	-	-	-	-	-	-	-	-	
(0xA7)	Reserved	-	-	-	-	-	-	-	-	
(0xA6)	Reserved	-	-	-	-	-	-	-	-	
(0xA5)	Reserved	-	-	-	-	-	-	-	-	
(0xA4)	Reserved	-	-	-	-	-	-	-	-	
(0xA3)	Reserved	-	-	-	-	-	-	-	-	
(0xA2)	Reserved	-	-	-	-	-	-	-	-	
(0xA1)	Reserved	-	-	-	-	-	-	-	-	
(0xA0)	Reserved	-	-	-	-	-	-	-	-	
(0x9F)	Reserved	-	-	-	-	-	-	-	-	
(0x9E)	Reserved	-	-	-	-	-	-	-	-	
(0x9D)	Reserved	-	-	-	-	-	-	-	-	
(0x9C)	Reserved	-	-	-	-	-	-	-	-	
(0x9B)	Reserved	-	-	-	-	-	-	-	-	
(0x9A)	Reserved	-	-	-	-	-	-	-	-	
(0x99)	Reserved	-	-	-	-	-	-	-	-	
(0x98)	Reserved	-	-	-	-	-	-	-	-	
(0x97)	Reserved	-	-	-	-	-	-	-	-	
(0x96)	Reserved	-	-	-	-	-	-	-	-	
(0x95)	Reserved	-	-	-	-	-	-	-	-	
(0x94)	Reserved	-	-	-	-	-	-	-	-	
(0x93)	Reserved	-	-	-	-	-	-	-	-	
(0x92)	Reserved	-	-	-	-	-	-	-	-	
(0x91)	Reserved	-	-	-	-	-	-	-	-	
(0x90)	Reserved	-	-	-	-	-	-	-	-	
(0x8F)	Reserved	-	-	-	-	-	-	-	-	
(0x8E)	Reserved	-	-	-	-	-	-	-	-	
(0x8D)	Reserved	-	-	-	-	-	-	-	-	
(0x8C)	Reserved	-	-	-	-	-	-	-	-	
(0x8B)	Reserved	-	-	-	-	-	-	-	-	
(0x8A)	Reserved	-	-	-	-	-	-	-	-	
(0x89)	OCR1B	Timer/Counter1 – Output Compare Register B								92
(0x88)	OCR1A	Timer/Counter1 – Output Compare Register A								91
(0x87)	Reserved	-	-	-	-	-	-	-	-	
(0x86)	Reserved	-	-	-	-	-	-	-	-	
(0x85)	TCNT1H	Timer/Counter1 (8 Bit) High Byte								91
(0x84)	TCNT1L	Timer/Counter1 (8 Bit) Low Byte								91
(0x83)	Reserved	-	-	-	-	-	-	-	-	
(0x82)	Reserved	-	-	-	-	-	-	-	-	
(0x81)	TCCR1B	-	-	-	-	-	CS12	CS11	CS10	76
(0x80)	TCCR1A	TCW1	ICEN1	ICNC1	ICES1	ICS1	-	-	WGM10	90
(0x7F)	Reserved	-	-	-	-	-	-	-	-	
(0x7E)	DIDR0	-	-	-	-	-	-	PA1DID	PA0DID	116



Address	Name	Bit 7	Bit 6	Bit 5	Bit 4	Bit 3	Bit 2	Bit 1	Bit 0	Page
(0x7D)	Reserved	–	–	–	–	–	–	–	–	
(0x7C)	VADMUX	–	–	–	–	VADMUX[3:0]				114
(0x7B)	Reserved	–	–	–	–	–	–	–	–	
(0x7A)	VADCSR	–	–	–	–	VADEN	VADSC	VADCCIF	VADCCIE	114
(0x79)	VADCH	–	–	–	–	VADC Data Register High byte				115
(0x78)	VADCL	VADC Data Register Low byte								115
(0x77)	Reserved	–	–	–	–	–	–	–	–	
(0x76)	Reserved	–	–	–	–	–	–	–	–	
(0x75)	Reserved	–	–	–	–	–	–	–	–	
(0x74)	Reserved	–	–	–	–	–	–	–	–	
(0x73)	Reserved	–	–	–	–	–	–	–	–	
(0x72)	Reserved	–	–	–	–	–	–	–	–	
(0x71)	Reserved	–	–	–	–	–	–	–	–	
(0x70)	Reserved	–	–	–	–	–	–	–	–	
(0x6F)	TIMSK1	–	–	–	–	ICIE1	OCIE1B	OCIE1A	TOIE1	92
(0x6E)	TIMSK0	–	–	–	–	ICIE0	OCIE0B	OCIE0A	TOIE0	92
(0x6D)	Reserved	–	–	–	–	–	–	–	–	
(0x6C)	Reserved	–	–	–	–	–	–	–	–	
(0x6B)	Reserved	–	–	–	–	–	–	–	–	
(0x6A)	Reserved	–	–	–	–	–	–	–	–	
(0x69)	EICRA	–	–	ISC21	ISC20	ISC11	ISC10	ISC01	ISC00	56
(0x68)	Reserved	–	–	–	–	–	–	–	–	
(0x67)	Reserved	–	–	–	–	–	–	–	–	
(0x66)	FOSCCAL	Fast Oscillator Calibration Register								30
(0x65)	Reserved	–	–	–	–	–	–	–	–	
(0x64)	PRR0	–	–	PRVRM	–	PRSPI	PRTIM1	PRTIM0	PRVADC	39
(0x63)	Reserved	–	–	–	–	–	–	–	–	
(0x62)	Reserved	–	–	–	–	–	–	–	–	
(0x61)	CLKPR	CLKPCE	–	–	–	–	–	CLKPS1	CLKPS0	31
(0x60)	WDTCR	WDIF	WDIE	WDP3	WDCE	WDE	WDP2	WDP1	WDP0	49
0x3F (0x5F)	SREG	I	T	H	S	V	N	Z	C	9
0x3E (0x5E)	SPH	SP15	SP14	SP13	SP12	SP11	SP10	SP9	SP8	12
0x3D (0x5D)	SPL	SP7	SP6	SP5	SP4	SP3	SP2	SP1	SP0	12
0x3C (0x5C)	Reserved	–	–	–	–	–	–	–	–	
0x3B (0x5B)	Reserved	–	–	–	–	–	–	–	–	
0x3A (0x5A)	Reserved	–	–	–	–	–	–	–	–	
0x39 (0x59)	Reserved	–	–	–	–	–	–	–	–	
0x38 (0x58)	Reserved	–	–	–	–	–	–	–	–	
0x37 (0x57)	SPMCSR	–	–	SIGRD	CTPB	RFLB	PGWRT	PGERS	SPMEN	147
0x36 (0x56)	Reserved	–	–	–	–	–	–	–	–	
0x35 (0x55)	MCUCR	–	–	CKOE	PUD	–	–	–	–	73/31
0x34 (0x54)	MCUSR	–	–	–	OCDRF	WDRF	BODRF	EXTRF	PORF	49
0x33 (0x53)	SMCR	–	–	–	–	SM[2:0]		–	SE	39
0x32 (0x52)	Reserved	–	–	–	–	–	–	–	–	
0x31 (0x51)	DWDR	debugWIRE Data Register								140
0x30 (0x50)	Reserved	–	–	–	–	–	–	–	–	
0x2F (0x4F)	Reserved	–	–	–	–	–	–	–	–	
0x2E (0x4E)	SPDR	SPI Data Register								103
0x2D (0x4D)	SPSR	SPIF	WCOL	–	–	–	–	–	SPI2X	102
0x2C (0x4C)	SPCR	SPIE	SPE	DORD	MSTR	CPOL	CPHA	SPR1	SPR0	101
0x2B (0x4B)	GPIOR2	General Purpose I/O Register 2								23
0x2A (0x4A)	GPIOR1	General Purpose I/O Register 1								23
0x29 (0x49)	OCR0B	Timer/Counter0 Output Compare Register B								92
0x28 (0x48)	OCR0A	Timer/Counter0 Output Compare Register A								91
0x27 (0x47)	TCNT0H	Timer/Counter0 (8 Bit) High Byte								91
0x26 (0x46)	TCNT0L	Timer/Counter0 (8 Bit) Low Byte								91
0x25 (0x45)	TCCR0B	–	–	–	–	–	CS02	CS01	CS00	76
0x24 (0x44)	TCCR0A	TCW0	ICEN0	ICNC0	ICES0	ICS0	–	–	WGM00	90
0x23 (0x43)	GTCCR	TSM	–	–	–	–	–	–	PSRSYNC	
0x22 (0x42)	Reserved	–	–	–	–	–	–	–	–	
0x21 (0x41)	EEAR	EEPROM Address Register Low Byte								19
0x20 (0x40)	EEDR	EEPROM Data Register								19
0x1F (0x3F)	EECR	–	–	EEMP1	EEMP0	EERIE	EEMPE	EEPE	EERE	19
0x1E (0x3E)	GPIOR0	General Purpose I/O Register 0								23
0x1D (0x3D)	EIMSK	–	–	–	–	–	INT2	INT1	INT0	57
0x1C (0x3C)	EIFR	–	–	–	–	–	INTF2	INTF1	INTF0	57

Address	Name	Bit 7	Bit 6	Bit 5	Bit 4	Bit 3	Bit 2	Bit 1	Bit 0	Page
0x1B (0x3B)	Reserved	–	–	–	–	–	–	–	–	
0x1A (0x3A)	Reserved	–	–	–	–	–	–	–	–	
0x19 (0x39)	Reserved	–	–	–	–	–	–	–	–	
0x18 (0x38)	Reserved	–	–	–	–	–	–	–	–	
0x17 (0x37)	OSICSR	–	–	–	OSISELO	–	–	OSIST	OSIEN	32
0x16 (0x36)	TIFR1	–	–	–	–	ICF1	OCF1B	OCF1A	TOV1	93
0x15 (0x35)	TIFR0	–	–	–	–	ICF0	OCF0B	OCF0A	TOV0	93
0x14 (0x34)	Reserved	–	–	–	–	–	–	–	–	
0x13 (0x33)	Reserved	–	–	–	–	–	–	–	–	
0x12 (0x32)	Reserved	–	–	–	–	–	–	–	–	
0x11 (0x31)	Reserved	–	–	–	–	–	–	–	–	
0x10 (0x30)	Reserved	–	–	–	–	–	–	–	–	
0x0F (0x2F)	Reserved	–	–	–	–	–	–	–	–	
0x0E (0x2E)	Reserved	–	–	–	–	–	–	–	–	
0x0D (0x2D)	Reserved	–	–	–	–	–	–	–	–	
0x0C (0x2C)	Reserved	–	–	–	–	–	–	–	–	
0x0B (0x2B)	Reserved	–	–	–	–	–	–	–	–	
0x0A (0x2A)	Reserved	–	–	–	–	–	–	–	–	
0x09 (0x29)	Reserved	–	–	–	–	–	–	–	–	
0x08 (0x28)	PORTC	–	–	–	–	–	–	–	PORTC0	62
0x07 (0x27)	Reserved	–	–	–	–	–	–	–	–	
0x06 (0x26)	PINC	–	–	–	–	–	–	–	PINC0	62
0x05 (0x25)	PORTB	–	–	–	–	PORTB3	PORTB2	PORTB1	PORTB0	73
0x04 (0x24)	DDRB	–	–	–	–	DDB3	DDB2	DDB1	DDB0	73
0x03 (0x23)	PINB	–	–	–	–	PINB3	PINB2	PINB1	PINB0	73
0x02 (0x22)	PORTA	–	–	–	–	–	–	PORTA1	PORTA0	73
0x01 (0x21)	DDRA	–	–	–	–	–	–	DDA1	DDA0	73
0x00 (0x20)	PINA	–	–	–	–	–	–	PINA1	PINA0	73

- Notes:
1. For compatibility with future devices, reserved bits should be written to zero if accessed. Reserved I/O memory addresses should never be written.
 2. I/O registers within the address range \$00 - \$1F are directly bit-accessible using the SBI and CBI instructions. In these registers, the value of single bits can be checked by using the SBIS and SBIC instructions.
 3. Some of the status flags are cleared by writing a logical one to them. Note that the CBI and SBI instructions will operate on all bits in the I/O register, writing a one back into any flag read as set, thus clearing the flag. The CBI and SBI instructions work with registers 0x00 to 0x1F only.
 4. When using the I/O specific commands IN and OUT, the I/O addresses \$00 - \$3F must be used. When addressing I/O registers as data space using LD and ST instructions, \$20 must be added to these addresses. The ATmega8HVA/16HVA is a complex microcontroller with more peripheral units than can be supported within the 64 location reserved in Opcode for the IN and OUT instructions. For the Extended I/O space from \$60 - \$FF in SRAM, only the ST/STS/STD and LD/LDS/LDD instructions can be used.

7. Instruction Set Summary

Mnemonics	Operands	Description	Operation	Flags	#Clocks
ARITHMETIC AND LOGIC INSTRUCTIONS					
ADD	Rd, Rr	Add two Registers	$Rd \leftarrow Rd + Rr$	Z,C,N,V,H	1
ADC	Rd, Rr	Add with Carry two Registers	$Rd \leftarrow Rd + Rr + C$	Z,C,N,V,H	1
ADIW	RdI,K	Add Immediate to Word	$Rdh:Rdl \leftarrow Rdh:Rdl + K$	Z,C,N,V,S	2
SUB	Rd, Rr	Subtract two Registers	$Rd \leftarrow Rd - Rr$	Z,C,N,V,H	1
SUBI	Rd, K	Subtract Constant from Register	$Rd \leftarrow Rd - K$	Z,C,N,V,H	1
SBC	Rd, Rr	Subtract with Carry two Registers	$Rd \leftarrow Rd - Rr - C$	Z,C,N,V,H	1
SBCI	Rd, K	Subtract with Carry Constant from Reg.	$Rd \leftarrow Rd - K - C$	Z,C,N,V,H	1
SBIW	RdI,K	Subtract Immediate from Word	$Rdh:Rdl \leftarrow Rdh:Rdl - K$	Z,C,N,V,S	2
AND	Rd, Rr	Logical AND Registers	$Rd \leftarrow Rd \cdot Rr$	Z,N,V	1
ANDI	Rd, K	Logical AND Register and Constant	$Rd \leftarrow Rd \cdot K$	Z,N,V	1
OR	Rd, Rr	Logical OR Registers	$Rd \leftarrow Rd \vee Rr$	Z,N,V	1
ORI	Rd, K	Logical OR Register and Constant	$Rd \leftarrow Rd \vee K$	Z,N,V	1
EOR	Rd, Rr	Exclusive OR Registers	$Rd \leftarrow Rd \oplus Rr$	Z,N,V	1
COM	Rd	One's Complement	$Rd \leftarrow 0xFF - Rd$	Z,C,N,V	1
NEG	Rd	Two's Complement	$Rd \leftarrow 0x00 - Rd$	Z,C,N,V,H	1
SBR	Rd,K	Set Bit(s) in Register	$Rd \leftarrow Rd \vee K$	Z,N,V	1
CBR	Rd,K	Clear Bit(s) in Register	$Rd \leftarrow Rd \cdot (0xFF - K)$	Z,N,V	1
INC	Rd	Increment	$Rd \leftarrow Rd + 1$	Z,N,V	1
DEC	Rd	Decrement	$Rd \leftarrow Rd - 1$	Z,N,V	1
TST	Rd	Test for Zero or Minus	$Rd \leftarrow Rd \cdot Rd$	Z,N,V	1
CLR	Rd	Clear Register	$Rd \leftarrow Rd \oplus Rd$	Z,N,V	1
SER	Rd	Set Register	$Rd \leftarrow 0xFF$	None	1
MUL	Rd, Rr	Multiply Unsigned	$R1:R0 \leftarrow Rd \times Rr$	Z,C	2
MULS	Rd, Rr	Multiply Signed	$R1:R0 \leftarrow Rd \times Rr$	Z,C	2
MULSU	Rd, Rr	Multiply Signed with Unsigned	$R1:R0 \leftarrow Rd \times Rr$	Z,C	2
FMUL	Rd, Rr	Fractional Multiply Unsigned	$R1:R0 \leftarrow (Rd \times Rr) \lll 1$	Z,C	2
FMULS	Rd, Rr	Fractional Multiply Signed	$R1:R0 \leftarrow (Rd \times Rr) \lll 1$	Z,C	2
FMULSU	Rd, Rr	Fractional Multiply Signed with Unsigned	$R1:R0 \leftarrow (Rd \times Rr) \lll 1$	Z,C	2
BRANCH INSTRUCTIONS					
RJMP	k	Relative Jump	$PC \leftarrow PC + k + 1$	None	2
IJMP		Indirect Jump to (Z)	$PC \leftarrow Z$	None	2
JMP ⁽¹⁾	k	Direct Jump	$PC \leftarrow k$	None	3
RCALL	k	Relative Subroutine Call	$PC \leftarrow PC + k + 1$	None	3
ICALL		Indirect Call to (Z)	$PC \leftarrow Z$	None	3
CALL ⁽¹⁾	k	Direct Subroutine Call	$PC \leftarrow k$	None	4
RET		Subroutine Return	$PC \leftarrow STACK$	None	4
RETI		Interrupt Return	$PC \leftarrow STACK$	I	4
CPSE	Rd,Rr	Compare, Skip if Equal	if (Rd = Rr) $PC \leftarrow PC + 2$ or 3	None	1/2/3
CP	Rd,Rr	Compare	$Rd - Rr$	Z, N, V, C, H	1
CPC	Rd,Rr	Compare with Carry	$Rd - Rr - C$	Z, N, V, C, H	1
CPI	Rd,K	Compare Register with Immediate	$Rd - K$	Z, N, V, C, H	1
SBRC	Rr, b	Skip if Bit in Register Cleared	if (Rr(b)=0) $PC \leftarrow PC + 2$ or 3	None	1/2/3
SBRS	Rr, b	Skip if Bit in Register is Set	if (Rr(b)=1) $PC \leftarrow PC + 2$ or 3	None	1/2/3
SBIC	P, b	Skip if Bit in I/O Register Cleared	if (P(b)=0) $PC \leftarrow PC + 2$ or 3	None	1/2/3
SBIS	P, b	Skip if Bit in I/O Register is Set	if (P(b)=1) $PC \leftarrow PC + 2$ or 3	None	1/2/3
BRBS	s, k	Branch if Status Flag Set	if (SREG(s) = 1) then $PC \leftarrow PC + k + 1$	None	1/2
BRBC	s, k	Branch if Status Flag Cleared	if (SREG(s) = 0) then $PC \leftarrow PC + k + 1$	None	1/2
BREQ	k	Branch if Equal	if (Z = 1) then $PC \leftarrow PC + k + 1$	None	1/2
BRNE	k	Branch if Not Equal	if (Z = 0) then $PC \leftarrow PC + k + 1$	None	1/2
BRCS	k	Branch if Carry Set	if (C = 1) then $PC \leftarrow PC + k + 1$	None	1/2
BRCC	k	Branch if Carry Cleared	if (C = 0) then $PC \leftarrow PC + k + 1$	None	1/2
BRSH	k	Branch if Same or Higher	if (C = 0) then $PC \leftarrow PC + k + 1$	None	1/2
BRLO	k	Branch if Lower	if (C = 1) then $PC \leftarrow PC + k + 1$	None	1/2
BRMI	k	Branch if Minus	if (N = 1) then $PC \leftarrow PC + k + 1$	None	1/2
BRPL	k	Branch if Plus	if (N = 0) then $PC \leftarrow PC + k + 1$	None	1/2
BRGE	k	Branch if Greater or Equal, Signed	if (N \oplus V = 0) then $PC \leftarrow PC + k + 1$	None	1/2
BRLT	k	Branch if Less Than Zero, Signed	if (N \oplus V = 1) then $PC \leftarrow PC + k + 1$	None	1/2
BRHS	k	Branch if Half Carry Flag Set	if (H = 1) then $PC \leftarrow PC + k + 1$	None	1/2
BRHC	k	Branch if Half Carry Flag Cleared	if (H = 0) then $PC \leftarrow PC + k + 1$	None	1/2
BRTS	k	Branch if T Flag Set	if (T = 1) then $PC \leftarrow PC + k + 1$	None	1/2
BRTC	k	Branch if T Flag Cleared	if (T = 0) then $PC \leftarrow PC + k + 1$	None	1/2
BRVS	k	Branch if Overflow Flag is Set	if (V = 1) then $PC \leftarrow PC + k + 1$	None	1/2
BRVC	k	Branch if Overflow Flag is Cleared	if (V = 0) then $PC \leftarrow PC + k + 1$	None	1/2

7. Instruction Set Summary (Continued)

Mnemonics	Operands	Description	Operation	Flags	#Clocks
BRIE	k	Branch if Interrupt Enabled	if (I = 1) then PC ← PC + k + 1	None	1/2
BRID	k	Branch if Interrupt Disabled	if (I = 0) then PC ← PC + k + 1	None	1/2
BIT AND BIT-TEST INSTRUCTIONS					
SBI	P,b	Set Bit in I/O Register	I/O(P,b) ← 1	None	2
CBI	P,b	Clear Bit in I/O Register	I/O(P,b) ← 0	None	2
LSL	Rd	Logical Shift Left	Rd(n+1) ← Rd(n), Rd(0) ← 0	Z,C,N,V	1
LSR	Rd	Logical Shift Right	Rd(n) ← Rd(n+1), Rd(7) ← 0	Z,C,N,V	1
ROL	Rd	Rotate Left Through Carry	Rd(0) ← C, Rd(n+1) ← Rd(n), C ← Rd(7)	Z,C,N,V	1
ROR	Rd	Rotate Right Through Carry	Rd(7) ← C, Rd(n) ← Rd(n+1), C ← Rd(0)	Z,C,N,V	1
ASR	Rd	Arithmetic Shift Right	Rd(n) ← Rd(n+1), n=0..6	Z,C,N,V	1
SWAP	Rd	Swap Nibbles	Rd(3..0) ← Rd(7..4), Rd(7..4) ← Rd(3..0)	None	1
BSET	s	Flag Set	SREG(s) ← 1	SREG(s)	1
BCLR	s	Flag Clear	SREG(s) ← 0	SREG(s)	1
BST	Rr, b	Bit Store from Register to T	T ← Rr(b)	T	1
BLD	Rd, b	Bit load from T to Register	Rd(b) ← T	None	1
SEC		Set Carry	C ← 1	C	1
CLC		Clear Carry	C ← 0	C	1
SEN		Set Negative Flag	N ← 1	N	1
CLN		Clear Negative Flag	N ← 0	N	1
SEZ		Set Zero Flag	Z ← 1	Z	1
CLZ		Clear Zero Flag	Z ← 0	Z	1
SEI		Global Interrupt Enable	I ← 1	I	1
CLI		Global Interrupt Disable	I ← 0	I	1
SES		Set Signed Test Flag	S ← 1	S	1
CLS		Clear Signed Test Flag	S ← 0	S	1
SEV		Set Twos Complement Overflow	V ← 1	V	1
CLV		Clear Twos Complement Overflow	V ← 0	V	1
SET		Set T in SREG	T ← 1	T	1
CLT		Clear T in SREG	T ← 0	T	1
SEH		Set Half Carry Flag in SREG	H ← 1	H	1
CLH		Clear Half Carry Flag in SREG	H ← 0	H	1
DATA TRANSFER INSTRUCTIONS					
MOV	Rd, Rr	Move Between Registers	Rd ← Rr	None	1
MOVW	Rd, Rr	Copy Register Word	Rd+1:Rd ← Rr+1:Rr	None	1
LDI	Rd, K	Load Immediate	Rd ← K	None	1
LD	Rd, X	Load Indirect	Rd ← (X)	None	2
LD	Rd, X+	Load Indirect and Post-Inc.	Rd ← (X), X ← X + 1	None	2
LD	Rd, -X	Load Indirect and Pre-Dec.	X ← X - 1, Rd ← (X)	None	2
LD	Rd, Y	Load Indirect	Rd ← (Y)	None	2
LD	Rd, Y+	Load Indirect and Post-Inc.	Rd ← (Y), Y ← Y + 1	None	2
LD	Rd, -Y	Load Indirect and Pre-Dec.	Y ← Y - 1, Rd ← (Y)	None	2
LDD	Rd, Y+q	Load Indirect with Displacement	Rd ← (Y + q)	None	2
LD	Rd, Z	Load Indirect	Rd ← (Z)	None	2
LD	Rd, Z+	Load Indirect and Post-Inc.	Rd ← (Z), Z ← Z + 1	None	2
LD	Rd, -Z	Load Indirect and Pre-Dec.	Z ← Z - 1, Rd ← (Z)	None	2
LDD	Rd, Z+q	Load Indirect with Displacement	Rd ← (Z + q)	None	2
LDS	Rd, k	Load Direct from SRAM	Rd ← (k)	None	2
ST	X, Rr	Store Indirect	(X) ← Rr	None	2
ST	X+, Rr	Store Indirect and Post-Inc.	(X) ← Rr, X ← X + 1	None	2
ST	-X, Rr	Store Indirect and Pre-Dec.	X ← X - 1, (X) ← Rr	None	2
ST	Y, Rr	Store Indirect	(Y) ← Rr	None	2
ST	Y+, Rr	Store Indirect and Post-Inc.	(Y) ← Rr, Y ← Y + 1	None	2
ST	-Y, Rr	Store Indirect and Pre-Dec.	Y ← Y - 1, (Y) ← Rr	None	2
STD	Y+q, Rr	Store Indirect with Displacement	(Y + q) ← Rr	None	2
ST	Z, Rr	Store Indirect	(Z) ← Rr	None	2
ST	Z+, Rr	Store Indirect and Post-Inc.	(Z) ← Rr, Z ← Z + 1	None	2
ST	-Z, Rr	Store Indirect and Pre-Dec.	Z ← Z - 1, (Z) ← Rr	None	2
STD	Z+q, Rr	Store Indirect with Displacement	(Z + q) ← Rr	None	2
STS	k, Rr	Store Direct to SRAM	(k) ← Rr	None	2
LPM		Load Program Memory	R0 ← (Z)	None	3
LPM	Rd, Z	Load Program Memory	Rd ← (Z)	None	3
LPM	Rd, Z+	Load Program Memory and Post-Inc	Rd ← (Z), Z ← Z + 1	None	3
SPM		Store Program Memory	(Z) ← R1:R0	None	-
IN	Rd, P	In Port	Rd ← P	None	1

7. Instruction Set Summary (Continued)

Mnemonics	Operands	Description	Operation	Flags	#Clocks
OUT	P, Rr	Out Port	P ← Rr	None	1
PUSH	Rr	Push Register on Stack	STACK ← Rr	None	2
POP	Rd	Pop Register from Stack	Rd ← STACK	None	2
MCU CONTROL INSTRUCTIONS					
NOP		No Operation		None	1
SLEEP		Sleep	(see specific descr. for Sleep function)	None	1
WDR		Watchdog Reset	(see specific descr. for WDR/timer)	None	1
BREAK		Break	For On-chip Debug Only	None	N/A

Note: 1. These instructions are only available in ATmega16HVA.

8. Ordering Information

8.1 ATmega8HVA

Speed (MHz)	Power Supply	Ordering Code	Package ⁽¹⁾	Operation Range
1 - 4	1.8 - 9.0V	ATmega8HVA-4CKU ATmega8HVA-4TU	36CK1 28T	-20 to +85°C

Notes: 1. Pb-free packaging, complies with the European Directive for Restriction of Hazardous Substances (RoHS directive). Also Halide free and fully Green.

Package Type	
36CK1	36-pad, (6.50 x 3.50 x 0.85 mm Body, 0.60 mm Pitch), Land Grid Array (LGA) Package.
28T	28-lead (8 x 13.4 mm) Plastic Thin Small Outline Package, Type I (TSOP)

8.2 ATmega16HVA

Speed (MHz)	Power Supply	Ordering Code	Package ⁽¹⁾	Operation Range
1 - 4	1.8 - 9.0V	ATmega16HVA-4CKU ATmega16HVA-4TU	36CK1 28T	-20 to +85°C

Notes: 1. Pb-free packaging, complies with the European Directive for Restriction of Hazardous Substances (RoHS directive). Also Halide free and fully Green.

Package Type	
36CK1	36-pad, (6.50 x 3.50 x 0.85 mm Body, 0.60 mm Pitch), Land Grid Array (LGA) Package.
28T	28-lead (8 x 13.4 mm) Plastic Thin Small Outline Package, Type I (TSOP)

9. Packaging Information

9.1 36CK1

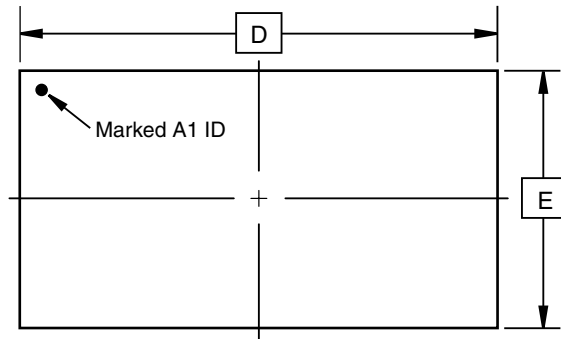

Top View

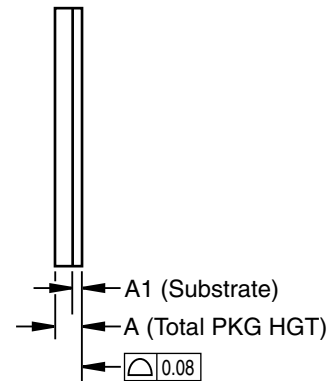

Side View

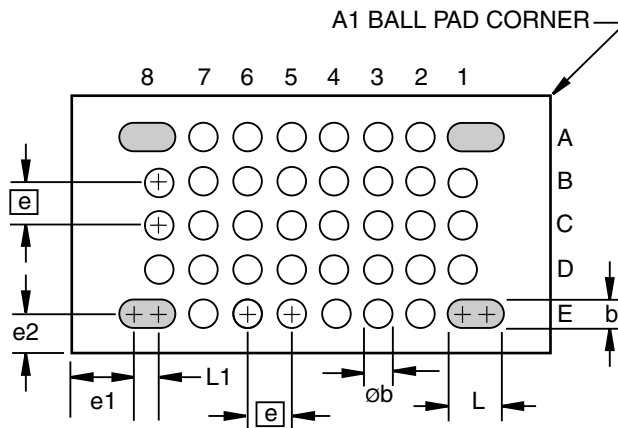

Bottom View

COMMON DIMENSIONS
(Unit of Measure = mm)

SYMBOL	MIN	NOM	MAX	NOTE
D	6.40	6.50	6.60	
E	3.40	3.50	3.60	
A	0.59	0.66	0.73	
A1	0.17	0.21	0.25	
L	0.70 REF			2
L1	0.35 REF			
b	0.35 REF			2
øb	0.32	0.35	0.38	2
e	0.60 TYP			
e1	0.80 REF			
e2	0.55 REF			

- Notes:
1. This drawing is for general information only.
 2. Metal pad dimensions.
 3.  => Dummy pad.

3/15/07



2325 Orchard Parkway
San Jose, CA 95131

TITLE

36CK1, 36-Pad, 6.50 x 3.50 x 0.73 mm Body,
0.60 mm Pitch, Land Grid Array (LGA) Package

DRAWING NO.

36CK1

REV.

D



9.2 28T

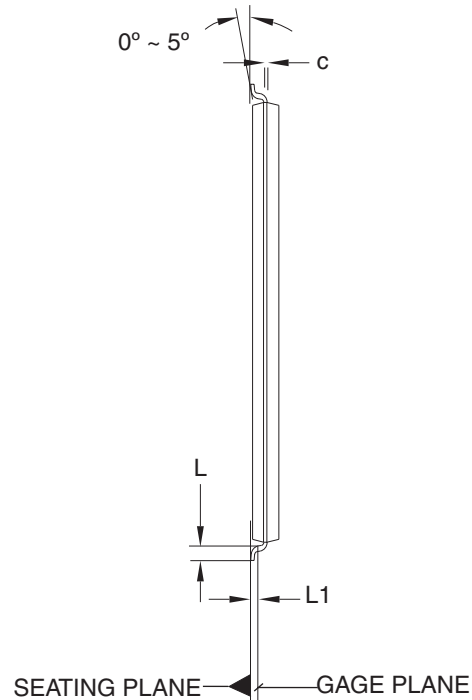
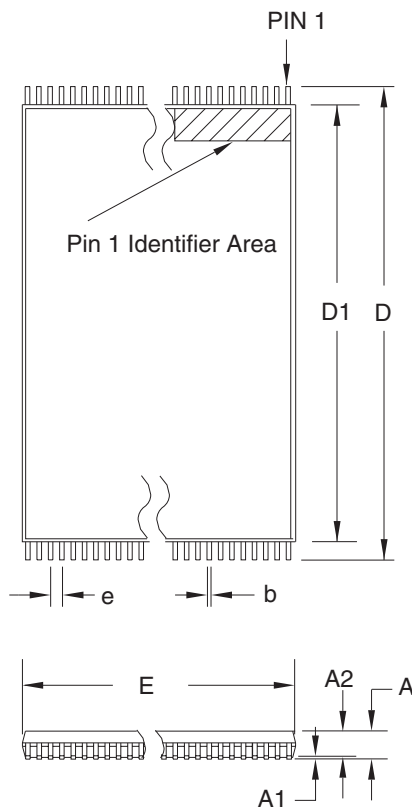

COMMON DIMENSIONS
(Unit of Measure = mm)

SYMBOL	MIN	NOM	MAX	NOTE
A	–	–	1.20	
A1	0.05	–	0.15	
A2	0.90	1.00	1.05	
D	13.20	13.40	13.60	
D1	11.70	11.80	11.90	Note 2
E	7.90	8.00	8.10	Note 2
L	0.50	0.60	0.70	
L1	0.25 BASIC			
b	0.17	0.22	0.27	
c	0.10	–	0.21	
e	0.55 BASIC			

- Notes:
1. This package conforms to JEDEC reference MO-183.
 2. Dimensions D1 and E do not include mold protrusion. Allowable protrusion on E is 0.15 mm per side and on D1 is 0.25 mm per side.
 3. Lead coplanarity is 0.10 mm maximum.

12/06/02



2325 Orchard Parkway
San Jose, CA 95131

TITLE

28T, 28-lead (8 x 13.4 mm) Plastic Thin Small Outline
Package, Type I (TSOP)

DRAWING NO.

28T

REV.

C

10. Errata

10.1 ATmega8HVA

10.1.1 Rev. A

No known errata.

10.2 ATmega16HVA

10.2.1 Rev. A

No known errata.

11. Datasheet Revision History

11.1 Rev. 8024A – 04/08

1. Initial revision



Headquarters

Atmel Corporation
2325 Orchard Parkway
San Jose, CA 95131
USA
Tel: 1(408) 441-0311
Fax: 1(408) 487-2600

International

Atmel Asia
Room 1219
Chinachem Golden Plaza
77 Mody Road Tsimshatsui
East Kowloon
Hong Kong
Tel: (852) 2721-9778
Fax: (852) 2722-1369

Atmel Europe
Le Krebs
8, Rue Jean-Pierre Timbaud
BP 309
78054 Saint-Quentin-en-
Yvelines Cedex
France
Tel: (33) 1-30-60-70-00
Fax: (33) 1-30-60-71-11

Atmel Japan
9F, Tonetsu Shinkawa Bldg.
1-24-8 Shinkawa
Chuo-ku, Tokyo 104-0033
Japan
Tel: (81) 3-3523-3551
Fax: (81) 3-3523-7581

Product Contact

Web Site
www.atmel.com

Technical Support
avr@atmel.com

Sales Contact
www.atmel.com/contacts

Literature Requests
www.atmel.com/literature

Disclaimer: The information in this document is provided in connection with Atmel products. No license, express or implied, by estoppel or otherwise, to any intellectual property right is granted by this document or in connection with the sale of Atmel products. **EXCEPT AS SET FORTH IN ATMEL'S TERMS AND CONDITIONS OF SALE LOCATED ON ATMEL'S WEB SITE, ATMEL ASSUMES NO LIABILITY WHATSOEVER AND DISCLAIMS ANY EXPRESS, IMPLIED OR STATUTORY WARRANTY RELATING TO ITS PRODUCTS INCLUDING, BUT NOT LIMITED TO, THE IMPLIED WARRANTY OF MERCHANTABILITY, FITNESS FOR A PARTICULAR PURPOSE, OR NON-INFRINGEMENT. IN NO EVENT SHALL ATMEL BE LIABLE FOR ANY DIRECT, INDIRECT, CONSEQUENTIAL, PUNITIVE, SPECIAL OR INCIDENTAL DAMAGES (INCLUDING, WITHOUT LIMITATION, DAMAGES FOR LOSS OF PROFITS, BUSINESS INTERRUPTION, OR LOSS OF INFORMATION) ARISING OUT OF THE USE OR INABILITY TO USE THIS DOCUMENT, EVEN IF ATMEL HAS BEEN ADVISED OF THE POSSIBILITY OF SUCH DAMAGES.** Atmel makes no representations or warranties with respect to the accuracy or completeness of the contents of this document and reserves the right to make changes to specifications and product descriptions at any time without notice. Atmel does not make any commitment to update the information contained herein. Unless specifically provided otherwise, Atmel products are not suitable for, and shall not be used in, automotive applications. Atmel's products are not intended, authorized, or warranted for use as components in applications intended to support or sustain life.

© 2008 Atmel Corporation. All rights reserved. Atmel®, logo and combinations thereof, AVR® and others are registered trademarks or trademarks of Atmel Corporation or its subsidiaries. Other terms and product names may be trademarks of others.