



# MCP73861/2/3/4

---

## Advanced Single or Dual Cell, Fully Integrated Li-Ion/Li-Polymer Charge Management Controllers

---

### Features:

- Linear Charge Management Controllers:
  - Integrated Pass Transistor
  - Integrated Current Sense
  - Reverse-Blocking Protection
- High-Accuracy Preset Voltage Regulation:  $\pm 0.5\%$
- Four Selectable Voltage Regulation Options:
  - 4.1V, 4.2V – **MCP73861/3**
  - 8.2V, 8.4V – **MCP73862/4**
- Programmable Charge Current: 1.2A Maximum
- Programmable Safety Charge Timers
- Preconditioning of Deeply Depleted Cells
- Automatic End-of-Charge Control
- Optional Continuous Cell Temperature Monitoring
- Charge Status Output for Direct LED Drive
- Fault Output for Direct LED Drive
- Automatic Power-Down
- Thermal Regulation
- Temperature Range:  $-40^{\circ}\text{C}$  to  $+85^{\circ}\text{C}$
- Packaging: 16-Pin, 4 x 4 QFN  
16-Pin SOIC

### Applications:

- Lithium-Ion/Lithium-Polymer Battery Chargers
- Personal Data Assistants (PDAs)
- Cellular Telephones
- Hand-Held Instruments
- Cradle Chargers
- Digital Cameras
- MP3 Players

### Description:

The MCP7386X family of devices features highly advanced linear charge management controllers for use in space-limited, cost-sensitive applications. The devices combine high-accuracy, constant voltage and current regulation, cell preconditioning, cell temperature monitoring, advanced safety timers, automatic charge termination, internal current sensing, reverse-blocking protection, charge status and fault indication in either a space-saving 16-pin 4 x 4 QFN package, or a 16-pin SOIC package. The MCP7386X provides a complete, fully functional, stand-alone charge management solution with a minimum number of external components.

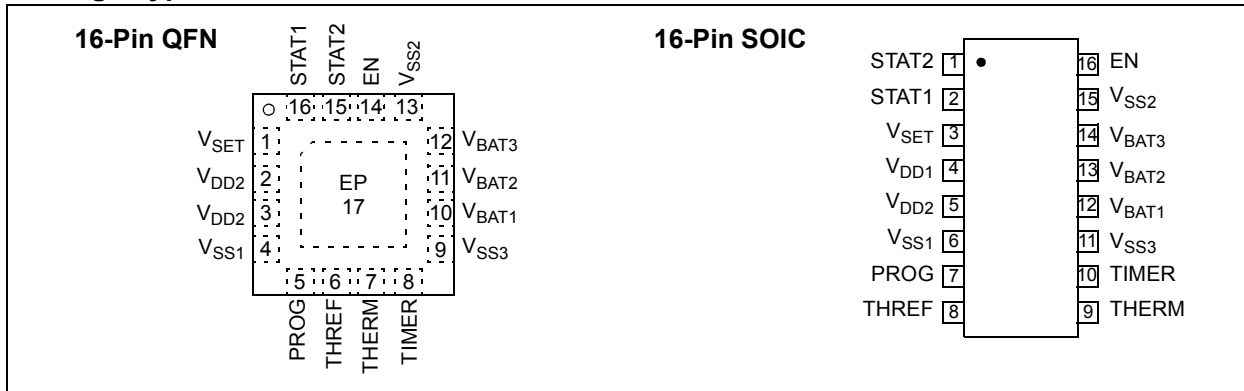
The MCP73861/3 is intended for applications utilizing single-cell Lithium-Ion or Lithium-Polymer battery packs, while the MCP73862/4 is intended for dual series cell Lithium-Ion or Lithium-Polymer battery packs. The MCP73861/3 has two selectable voltage-regulation options available (4.1V and 4.2V), for use with either coke or graphite anodes and operate with an input voltage range of 4.5V to 12V. The MCP73862/4 has two selectable voltage-regulation options available (8.2V and 8.4V), for use with coke or graphite anodes, and operate with an input voltage range of 8.7V to 12V.

The MCP73861/2 and MCP73863/4 differ only in the function of the charge status output (STAT1) when a charge cycle has been completed. The MCP73861/2 flashes the output, while the MCP73863/4 turns the output off. Refer to [Section 5.2.1 “Charge Status Outputs \(STAT1, STAT2\)”](#).

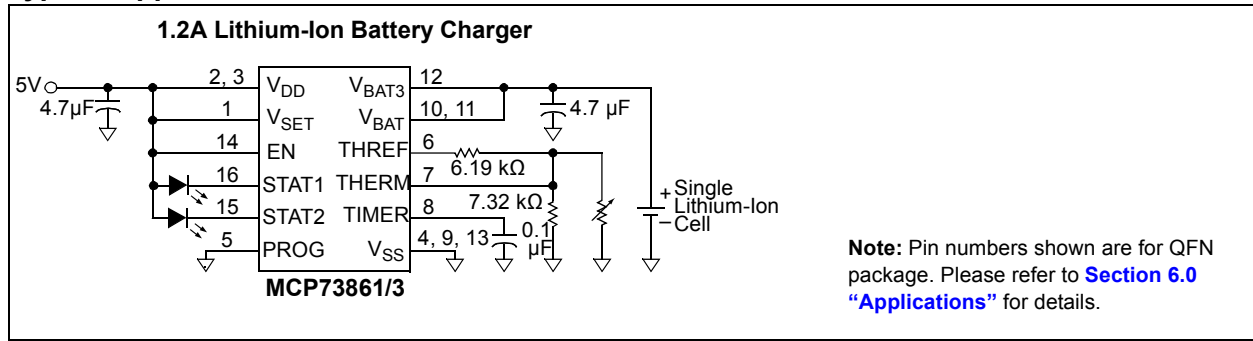
The MCP7386X family of devices are fully specified over the ambient temperature range of  $-40^{\circ}\text{C}$  to  $+85^{\circ}\text{C}$ .

# MCP73861/2/3/4

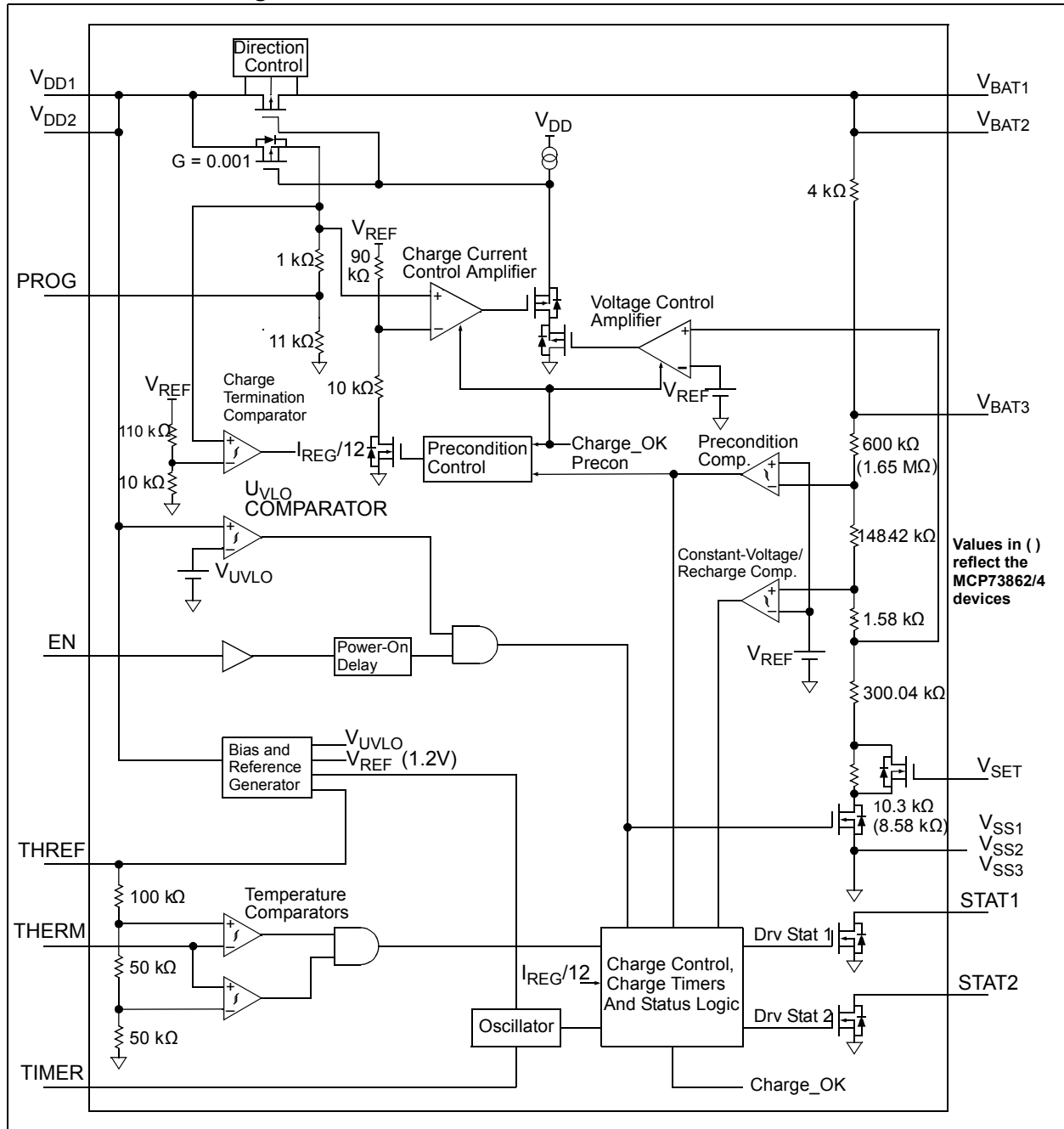
## Package Types



## Typical Application



## Functional Block Diagram



# MCP73861/2/3/4

## 1.0 ELECTRICAL CHARACTERISTICS

### Absolute Maximum Ratings†

$V_{DDN}$ .....	13.5V
$V_{BATN}$ , $V_{SET}$ , EN, STAT1, STAT2 w.r.t. $V_{SS}$ .....	-0.3 to ( $V_{DD} + 0.3$ )V
PROG, THREF, THERM, TIMER w.r.t. $V_{SS}$ .....	-0.3 to 6V
Maximum Junction Temperature, $T_J$ .....	Internally Limited
Storage temperature .....	-65°C to +150°C
ESD protection on all pins:	
Human Body Model (1.5 k $\Omega$ in series with 100 pF)....	$\geq 4$ kV
Machine Model (200 pF, No series resistance) .....	300V

† **Notice:** Stresses above those listed under “Maximum Ratings” may cause permanent damage to the device. This is a stress rating only and functional operation of the device at those or any other conditions above those indicated in the operational listings of this specification is not implied. Exposure to maximum rating conditions for extended periods may affect device reliability.

### DC CHARACTERISTICS

Electrical Specifications: Unless otherwise indicated, all limits apply for $V_{DD} = [V_{REG}(typ.) + 0.3V]$ to 12V, $T_A = -40^\circ\text{C}$ to $+85^\circ\text{C}$ . Typical values are at $+25^\circ\text{C}$ , $V_{DD} = [V_{REG}(typ.) + 1.0V]$						
Parameters	Sym.	Min.	Typ.	Max.	Units	Conditions
<b>Supply Input</b>						
Supply Voltage	$V_{DD}$	4.5	—	12	V	<b>MCP73861/3</b>
		8.7	—	12	V	<b>MCP73862/4</b>
Supply Current	$I_{SS}$	—	0.17	4	$\mu\text{A}$	Disabled
		—	0.53	4	mA	Operating
UVLO Start Threshold	$V_{START}$	4.25	4.5	4.65	V	<b>MCP73861/3</b>
		8.45	8.8	9.05	V	<b>MCP73862/4</b> $V_{DD}$ Low-to-High
UVLO Stop Threshold	$V_{STOP}$	4.20	4.4	4.55	V	<b>MCP73861/3</b>
		8.40	8.7	8.95	V	<b>MCP73862/4</b> $V_{DD}$ High-to-Low
<b>Voltage Regulation (Constant-Voltage Mode)</b>						
Regulated Output Voltage	$V_{REG}$	4.079	4.1	4.121	V	<b>MCP73861/3</b> , $V_{SET} = V_{SS}$
		4.179	4.2	4.221	V	<b>MCP73861/3</b> , $V_{SET} = V_{DD}$
		8.159	8.2	8.241	V	<b>MCP73862/4</b> , $V_{SET} = V_{SS}$
		8.358	8.4	8.442	V	<b>MCP73862/4</b> , $V_{SET} = V_{DD}$
$V_{DD} = [V_{REG}(typ.) + 1V]$ , $I_{OUT} = 10$ mA $T_A = -5^\circ\text{C}$ to $+55^\circ\text{C}$						
Line Regulation	$ \Delta V_{BAT} / V_{BAT}  / \Delta V_{DD}$	—	0.025	0.25	%/V	$V_{DD} = [V_{REG}(typ.) + 1V]$ to 12V $I_{OUT} = 10$ mA
Load Regulation	$ \Delta V_{BAT} / V_{BAT} $	—	0.01	0.25	%	$I_{OUT} = 10$ mA to 150 mA $V_{DD} = [V_{REG}(typ.) + 1V]$
Supply Ripple Attenuation	PSRR	—	60	—	dB	$I_{OUT} = 10$ mA, 10 Hz to 1 kHz
		—	42	—	dB	$I_{OUT} = 10$ mA, 10 Hz to 10 kHz
		—	28	—	dB	$I_{OUT} = 10$ mA, 10 Hz to 1 MHz
Output Reverse Leakage Current	$I_{DISCHARGE}$	—	0.23	1	$\mu\text{A}$	$V_{DD} < V_{BAT} = V_{REG}(typ.)$ , $V_{DD} = 1.5$ k $\Omega$ to Ground
Output Reverse Leakage Switchover Time	$I_{DISCHARGE\_SW}$	—	0	1000	ms	$V_{DD} < V_{BAT}$ , $V_{DD} \leq 1.5$ k $\Omega$ to Ground

## DC CHARACTERISTICS (CONTINUED)

Electrical Specifications: Unless otherwise indicated, all limits apply for $V_{DD} = [V_{REG}(typ.) + 0.3V]$ to 12V, $T_A = -40^\circ C$ to $+85^\circ C$ . Typical values are at $+25^\circ C$ , $V_{DD} = [V_{REG}(typ.) + 1.0V]$						
Parameters	Sym.	Min.	Typ.	Max.	Units	Conditions
<b>Current Regulation (Fast Charge Constant-Current Mode)</b>						
Fast Charge Current Regulation	$I_{REG}$	85	100	115	mA	PROG = OPEN
		1020	1200	1380	mA	PROG = $V_{SS}$
		425	500	575	mA	PROG = 1.6 k $\Omega$ $T_A = -5^\circ C$ to $+55^\circ C$
<b>Preconditioning Current Regulation (Trickle Charge Constant-Current Mode)</b>						
Precondition Current Regulation	$I_{PREG}$	5	10	15	mA	PROG = OPEN
		60	120	180	mA	PROG = $V_{SS}$
		25	50	75	mA	PROG = 1.6 k $\Omega$ $T_A = -5^\circ C$ to $+55^\circ C$
Precondition Threshold Voltage	$V_{PTH}$	2.70	2.80	2.90	V	MCP73861/3, $V_{SET} = V_{SS}$
		2.75	2.85	2.95	V	MCP73861/3, $V_{SET} = V_{DD}$
		5.40	5.60	5.80	V	MCP73862/4, $V_{SET} = V_{SS}$
		5.50	5.70	5.90	V	MCP73862/4, $V_{SET} = V_{DD}$ $V_{BAT}$ Low-to-High
<b>Charge Termination</b>						
Charge Termination Current	$I_{TERM}$	6	8.5	11	mA	PROG = OPEN
		70	90	120	mA	PROG = $V_{SS}$
		32	41	50	mA	PROG = 1.6 k $\Omega$ $T_A = -5^\circ C$ to $+55^\circ C$
<b>Automatic Recharge</b>						
Recharge Threshold Voltage	$V_{RTH}$	$V_{REG} - 300$ mV	$V_{REG} - 200$ mV	$V_{REG} - 100$ mV	V	MCP73861/3
		$V_{REG} - 600$ mV	$V_{REG} - 400$ mV	$V_{REG} - 200$ mV	V	MCP73862/4 $V_{BAT}$ High-to-Low
<b>Thermistor Reference</b>						
Thermistor Reference Output Voltage	$V_{THREF}$	2.475	2.55	2.625	V	$T_A = 25^\circ C$ , $V_{DD} = V_{REG}(typ.) + 1V$ , $I_{THREF} = 0$ mA
Thermistor Reference Source Current	$I_{THREF}$	200	—	—	$\mu A$	
Thermistor Reference Line Regulation	$ \frac{\Delta V_{THREF}}{V_{THREF}}  / \frac{\Delta V_{DD}}{V_{DD}}$	—	0.1	0.25	%/V	$V_{DD} = [V_{REG}(typ.) + 1V]$ to 12V
Thermistor Reference Load Regulation	$ \frac{\Delta V_{THREF}}{V_{THREF}} $	—	0.01	0.10	%	$I_{THREF} = 0$ mA to 0.20 mA
<b>Thermistor Comparator</b>						
Upper Trip Threshold	$V_{T1}$	1.18	1.25	1.32	V	
Upper Trip Point Hysteresis	$V_{T1HYS}$	—	-50	—	mV	
Lower Trip Threshold	$V_{T2}$	0.59	0.62	0.66	V	
Lower Trip Point Hysteresis	$V_{T2HYS}$	—	80	—	mV	
Input Bias Current	$I_{BIAS}$	—	—	2	$\mu A$	
<b>Status Indicator – STAT1, STAT2</b>						
Sink Current	$I_{SINK}$	4	8	12	mA	
Low Output Voltage	$V_{OL}$	—	200	400	mV	$I_{SINK} = 1$ mA
Input Leakage Current	$I_{LK}$	—	0.01	1	$\mu A$	$I_{SINK} = 0$ mA, $V_{STAT1,2} = 12V$

# MCP73861/2/3/4

## DC CHARACTERISTICS (CONTINUED)

**Electrical Specifications:** Unless otherwise indicated, all limits apply for  $V_{DD} = [V_{REG}(typ.) + 0.3V]$  to 12V,  $T_A = -40^{\circ}C$  to  $+85^{\circ}C$ . Typical values are at  $+25^{\circ}C$ ,  $V_{DD} = [V_{REG}(typ.) + 1.0V]$

Parameters	Sym.	Min.	Typ.	Max.	Units	Conditions
<b>Enable Input</b>						
Input High Voltage Level	$V_{IH}$	1.4	—	—	V	
Input Low Voltage Level	$V_{IL}$	—	—	0.8	V	
Input Leakage Current	$I_{LK}$	—	0.01	1	$\mu A$	$V_{ENABLE} = 12V$
<b>Thermal Shutdown</b>						
Die Temperature	$T_{SD}$	—	155	—	$^{\circ}C$	
Die Temperature Hysteresis	$T_{SDHYS}$	—	10	—	$^{\circ}C$	

## AC CHARACTERISTICS

**Electrical Specifications:** Unless otherwise indicated, all limits apply for  $V_{DD} = [V_{REG}(typ.) + 0.3V]$  to 12V,  $T_A = -40^{\circ}C$  to  $+85^{\circ}C$ . Typical values are at  $+25^{\circ}C$ ,  $V_{DD} = [V_{REG}(typ.) + 1.0V]$

Parameters	Sym.	Min.	Typ.	Max.	Units	Conditions
UVLO Start Delay	$t_{START}$	—	—	5	ms	$V_{DD}$ Low-to-High
<b>Current Regulation</b>						
Transition Time Out of Preconditioning	$t_{DELAY}$	—	—	1	ms	$V_{BAT} < V_{PTH}$ to $V_{BAT} > V_{PTH}$
Current Rise Time Out of Preconditioning	$t_{RISE}$	—	—	1	ms	$I_{OUT}$ Rising to 90% of $I_{REG}$
Fast Charge Safety Timer Period	$t_{FAST}$	1.1	1.5	1.9	Hours	$C_{TIMER} = 0.1 \mu F$
<b>Preconditioning Current Regulation</b>						
Preconditioning Charge Safety Timer Period	$t_{PRECON}$	45	60	75	Minutes	$C_{TIMER} = 0.1 \mu F$
<b>Charge Termination</b>						
Elapsed Time Termination Period	$t_{TERM}$	2.2	3	3.8	Hours	$C_{TIMER} = 0.1 \mu F$
<b>Status Indicators</b>						
Status Output turn-off	$t_{OFF}$	—	—	200	$\mu s$	$I_{SINK} = 1 mA$ to 0 mA
Status Output turn-on	$t_{ON}$	—	—	200	$\mu s$	$I_{SINK} = 0 mA$ to 1 mA

## TEMPERATURE SPECIFICATIONS

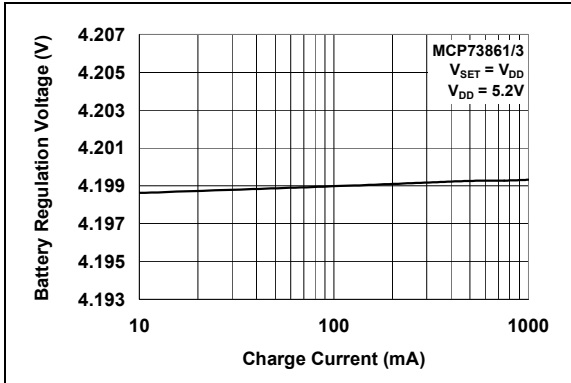
**Electrical Specifications:** Unless otherwise indicated, all limits apply for  $V_{DD} = [V_{REG}(typ.) + 0.3V]$  to 12V. Typical values are at  $+25^{\circ}C$ ,  $V_{DD} = [V_{REG}(typ.) + 1.0V]$

Parameters	Sym.	Min.	Typ.	Max.	Units	Conditions
<b>Temperature Ranges</b>						
Specified Temperature Range	$T_A$	-40	—	+85	$^{\circ}C$	
Operating Temperature Range	$T_J$	-40	—	+125	$^{\circ}C$	
Storage Temperature Range	$T_A$	-65	—	+150	$^{\circ}C$	
<b>Thermal Package Resistances</b>						
Thermal Resistance, 16-lead, 4 mm x 4 mm QFN	$\theta_{JA}$	—	47	—	$^{\circ}C/W$	4-Layer JC51-7 Standard Board, Natural Convection
Thermal Resistance, 16-lead SOIC	$\theta_{JA}$	—	86.1	—	$^{\circ}C/W$	4-Layer JC51-7 Standard Board, Natural Convection

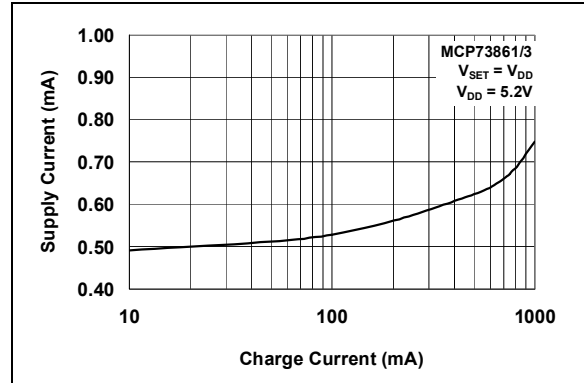
## 2.0 TYPICAL PERFORMANCE CURVES

**Note:** The graphs and tables provided following this note are a statistical summary based on a limited number of samples and are provided for informational purposes only. The performance characteristics listed herein are not tested or guaranteed. In some graphs or tables, the data presented may be outside the specified operating range (e.g., outside specified power supply range) and therefore outside the warranted range.

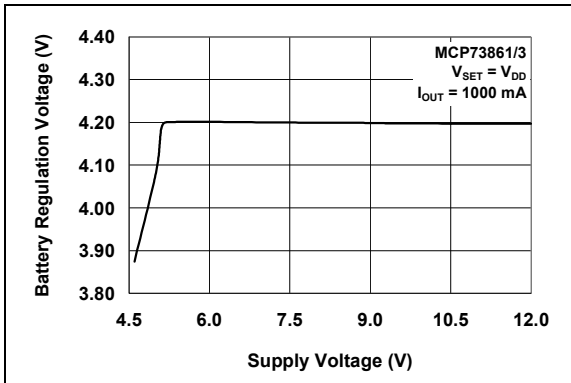
**NOTE:** Unless otherwise indicated,  $V_{DD} = [V_{REG}(typ.) + 1V]$ ,  $I_{OUT} = 10\text{ mA}$  and  $T_A = +25^\circ\text{C}$ , Constant-voltage mode.



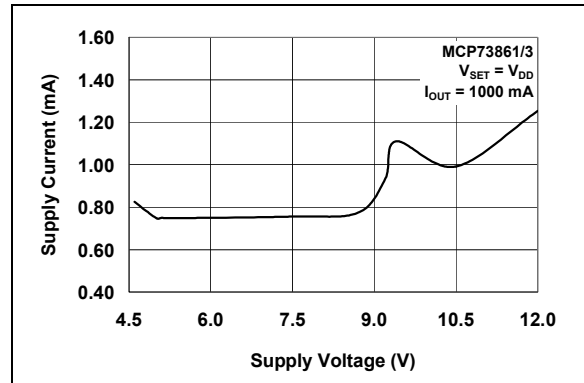
**FIGURE 2-1:** Battery Regulation Voltage ( $V_{BAT}$ ) vs. Charge Current ( $I_{OUT}$ ).



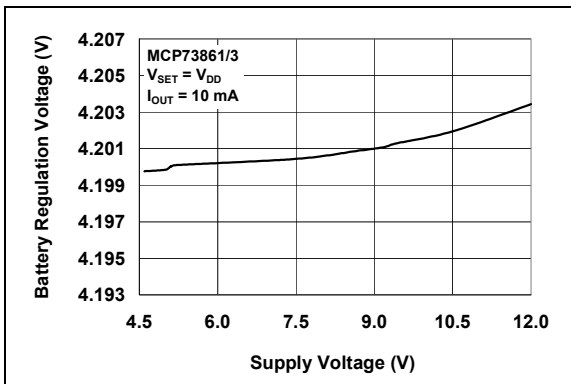
**FIGURE 2-4:** Supply Current ( $I_{SS}$ ) vs. Charge Current ( $I_{OUT}$ ).



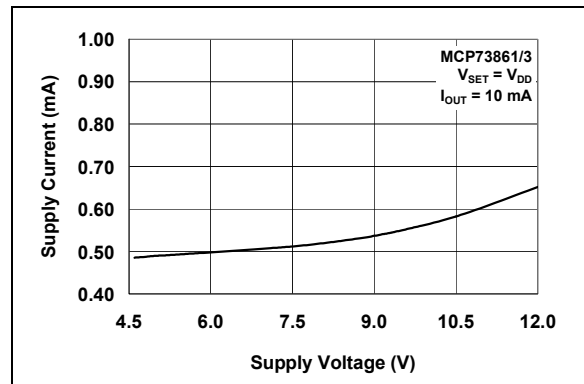
**FIGURE 2-2:** Battery Regulation Voltage ( $V_{BAT}$ ) vs. Supply Voltage ( $V_{DD}$ ).



**FIGURE 2-5:** Supply Current ( $I_{SS}$ ) vs. Supply Voltage ( $V_{DD}$ ).



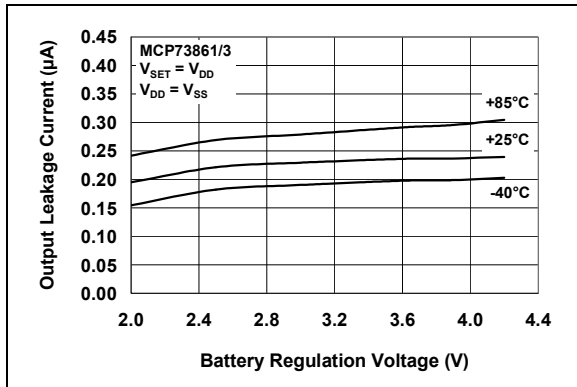
**FIGURE 2-3:** Battery Regulation Voltage ( $V_{BAT}$ ) vs. Supply Voltage ( $V_{DD}$ ).



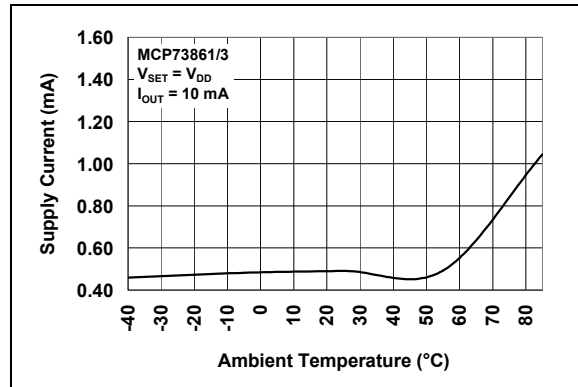
**FIGURE 2-6:** Supply Current ( $I_{SS}$ ) vs. Supply Voltage ( $V_{DD}$ ).

# MCP73861/2/3/4

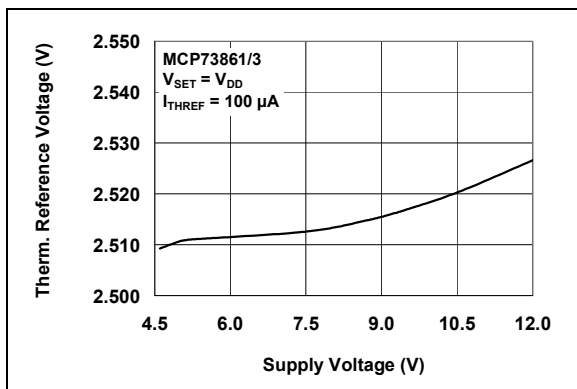
**NOTE:** Unless otherwise indicated,  $V_{DD} = [V_{REG}(typ.) + 1V]$ ,  $I_{OUT} = 10\text{ mA}$  and  $T_A = +25^\circ\text{C}$ , Constant-voltage mode.



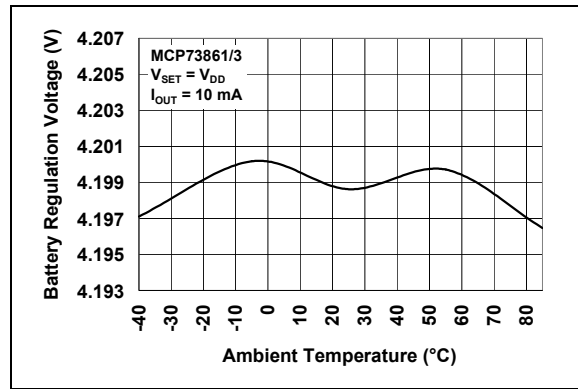
**FIGURE 2-7:** Output Leakage Current ( $I_{DISCHARGE}$ ) vs. Battery Regulation Voltage ( $V_{BAT}$ ).



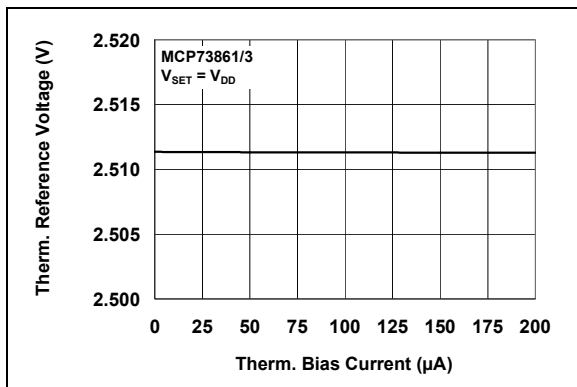
**FIGURE 2-10:** Supply Current ( $I_{SS}$ ) vs. Ambient Temperature ( $T_A$ ).



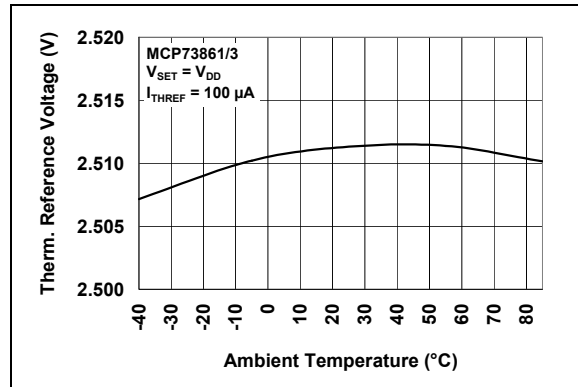
**FIGURE 2-8:** Thermistor Reference Voltage ( $V_{THREF}$ ) vs. Supply Voltage ( $V_{DD}$ ).



**FIGURE 2-11:** Battery Regulation Voltage ( $V_{BAT}$ ) vs. Ambient Temperature ( $T_A$ ).



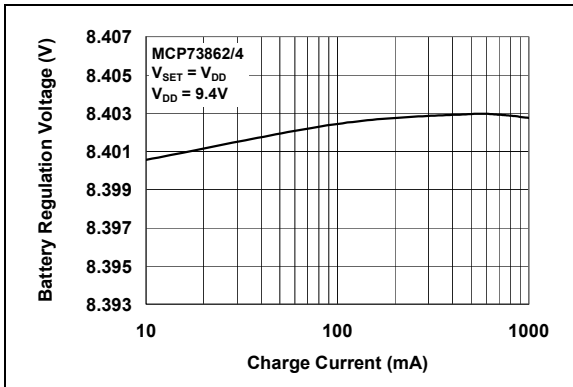
**FIGURE 2-9:** Thermistor Reference Voltage ( $V_{THREF}$ ) vs. Thermistor Bias Current ( $I_{THREF}$ ).



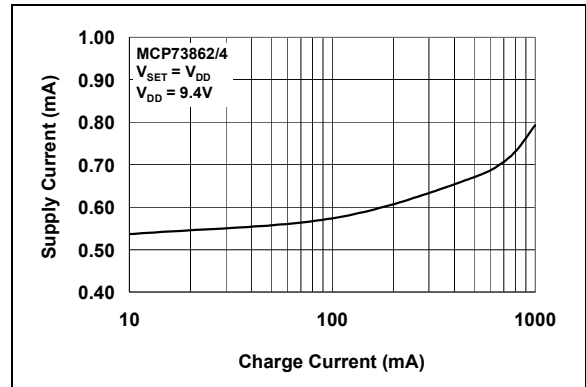
**FIGURE 2-12:** Thermistor Reference Voltage ( $V_{THREF}$ ) vs. Ambient Temperature ( $T_A$ ).



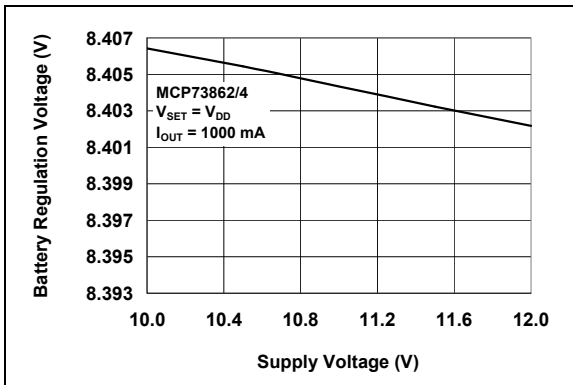
**NOTE:** Unless otherwise indicated,  $V_{DD} = [V_{REG}(typ.) + 1V]$ ,  $I_{OUT} = 10\text{ mA}$  and  $T_A = +25^\circ\text{C}$ , Constant-voltage mode.



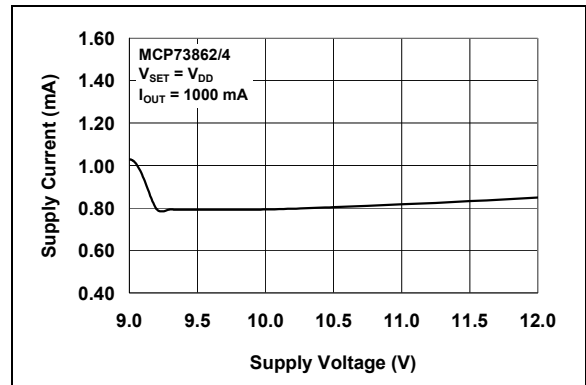
**FIGURE 2-13:** Battery Regulation Voltage ( $V_{BAT}$ ) vs. Charge Current ( $I_{OUT}$ ).



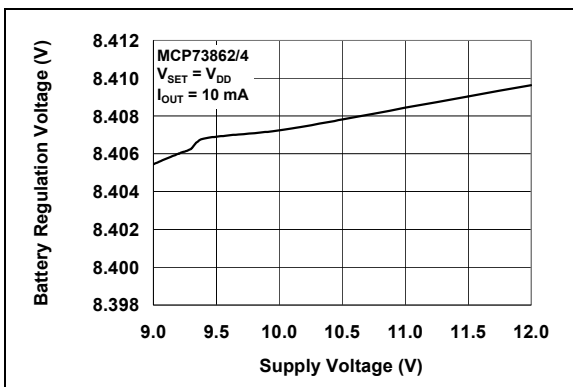
**FIGURE 2-16:** Supply Current ( $I_{SS}$ ) vs. Charge Current ( $I_{OUT}$ ).



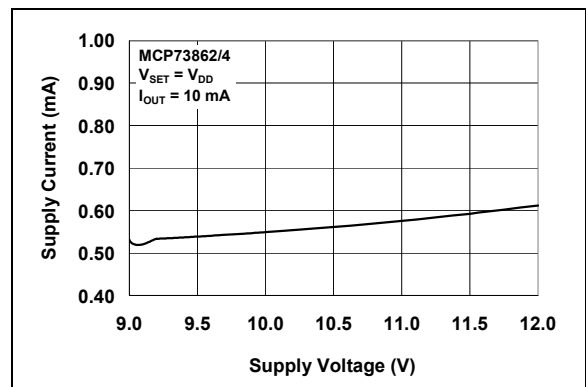
**FIGURE 2-14:** Battery Regulation Voltage ( $V_{BAT}$ ) vs. Supply Voltage ( $V_{DD}$ ).



**FIGURE 2-17:** Supply Current ( $I_{SS}$ ) vs. Supply Voltage ( $V_{DD}$ ).



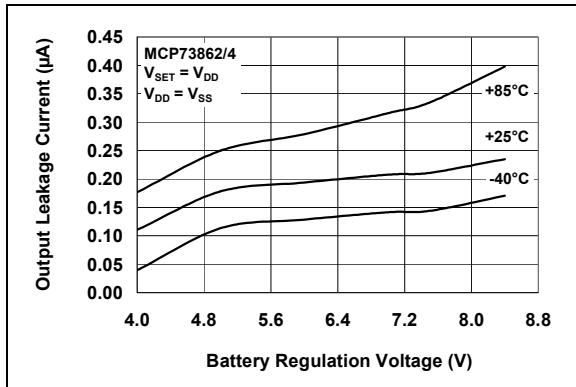
**FIGURE 2-15:** Battery Regulation Voltage ( $V_{BAT}$ ) vs. Supply Voltage ( $V_{DD}$ ).



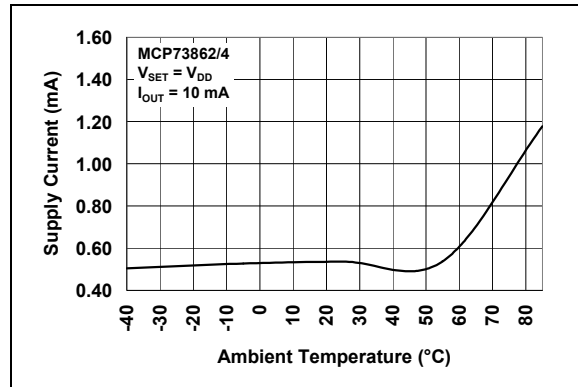
**FIGURE 2-18:** Supply Current ( $I_{SS}$ ) vs. Supply Voltage ( $V_{DD}$ ).

# MCP73861/2/3/4

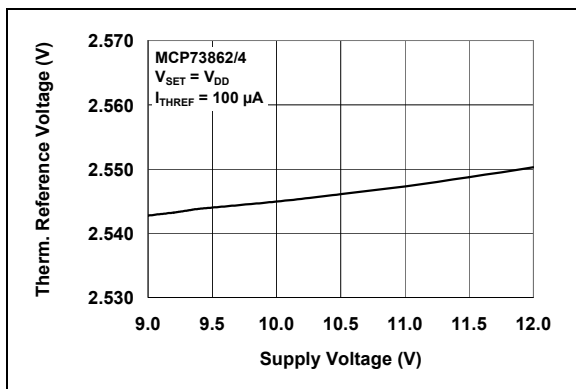
**NOTE:** Unless otherwise indicated,  $V_{DD} = [V_{REG}(typ.) + 1V]$ ,  $I_{OUT} = 10\text{ mA}$  and  $T_A = +25^\circ\text{C}$ , Constant-voltage mode.



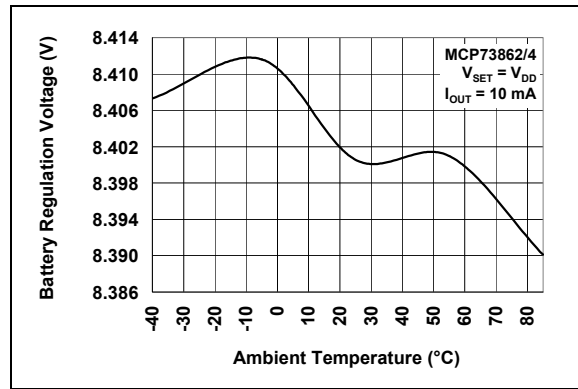
**FIGURE 2-19:** Output Leakage Current ( $I_{DISCHARGE}$ ) vs. Battery Regulation Voltage ( $V_{BAT}$ ).



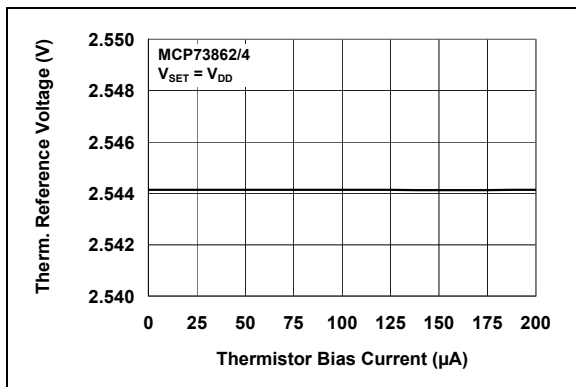
**FIGURE 2-22:** Supply Current ( $I_{SS}$ ) vs. Ambient Temperature ( $T_A$ ).



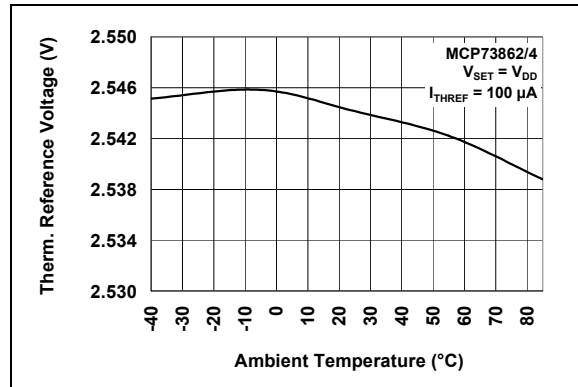
**FIGURE 2-20:** Thermistor Reference Voltage ( $V_{THREF}$ ) vs. Supply Voltage ( $V_{DD}$ ).



**FIGURE 2-23:** Battery Regulation Voltage ( $V_{BAT}$ ) vs. Ambient Temperature ( $T_A$ ).



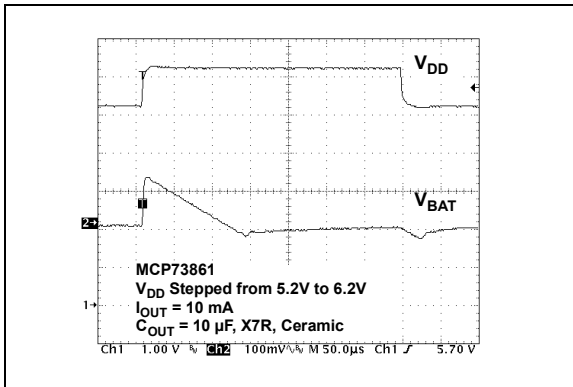
**FIGURE 2-21:** Thermistor Reference Voltage ( $V_{THREF}$ ) vs. Thermistor Bias Current ( $I_{THREF}$ ).



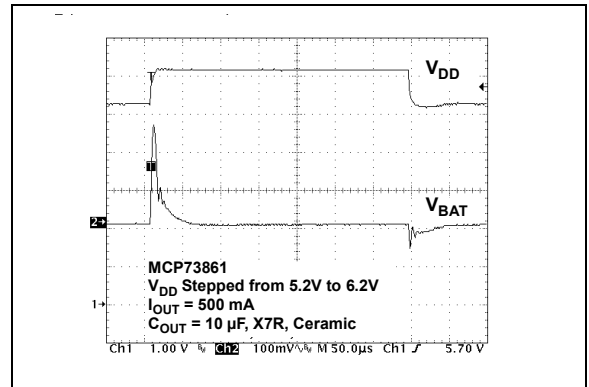
**FIGURE 2-24:** Thermistor Reference Voltage ( $V_{THREF}$ ) vs. Ambient Temperature ( $T_A$ ).

# MCP73861/2/3/4

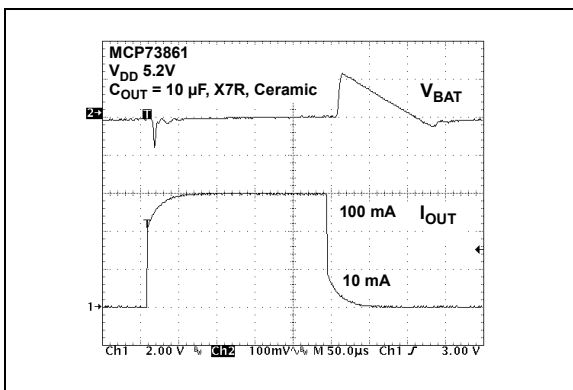
**NOTE:** Unless otherwise indicated,  $V_{DD} = [V_{REG}(typ.) + 1V]$ ,  $I_{OUT} = 10\text{ mA}$  and  $T_A = +25^\circ\text{C}$ , Constant-voltage mode.



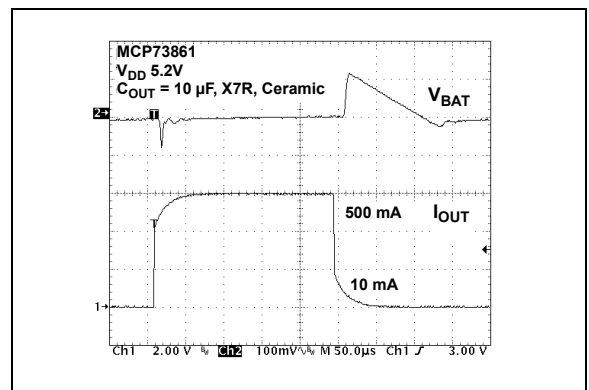
**FIGURE 2-25:** Line Transient Response.



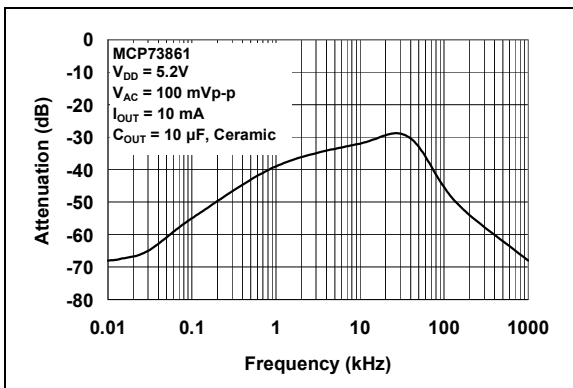
**FIGURE 2-28:** Line Transient Response.



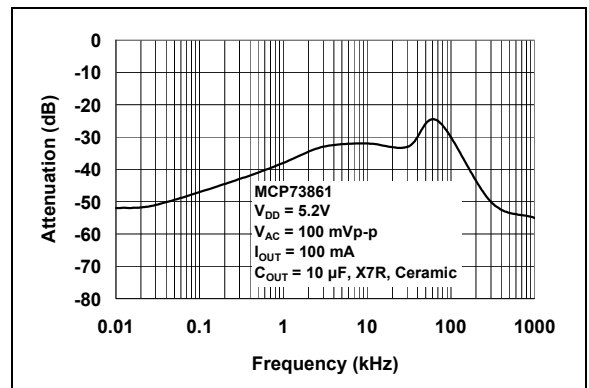
**FIGURE 2-26:** Load Transient Response.



**FIGURE 2-29:** Load Transient Response.



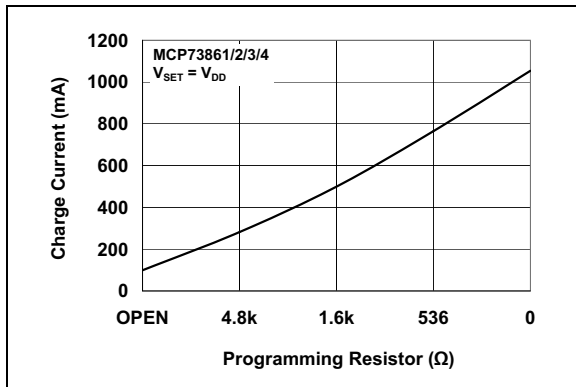
**FIGURE 2-27:** Power Supply Ripple Rejection.



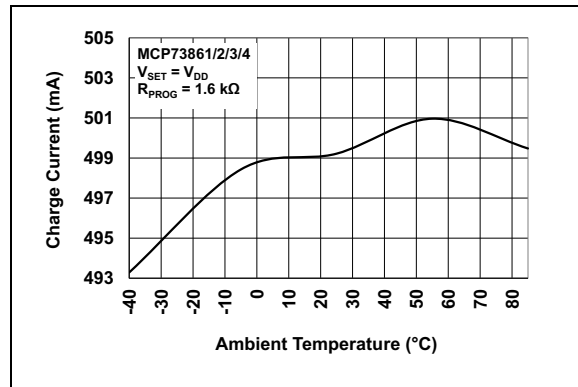
**FIGURE 2-30:** Power Supply Ripple Rejection.

# MCP73861/2/3/4

**NOTE:** Unless otherwise indicated,  $V_{DD} = [V_{REG}(typ.) + 1V]$ ,  $I_{OUT} = 10\text{ mA}$  and  $T_A = +25^\circ\text{C}$ , Constant-voltage mode.



**FIGURE 2-31:** Charge Current ( $I_{OUT}$ ) vs. Programming Resistor ( $R_{PROG}$ ).



**FIGURE 2-32:** Charge Current ( $I_{OUT}$ ) vs. Ambient Temperature ( $T_A$ ).

## 3.0 PIN DESCRIPTION

The descriptions of the pins are listed in [Table 3.1](#).

**TABLE 3-1: PIN FUNCTION TABLE**

MCP73861/2/3/4		Symbol	Function
QFN	SOIC		
1	3	$V_{SET}$	Voltage Regulation Selection
2	4	$V_{DD1}$	Battery Management Input Supply
3	5	$V_{DD2}$	Battery Management Input Supply
4	6	$V_{SS1}$	Battery Management 0V Reference
5	7	PROG	Current Regulation Set
6	8	THREF	Cell Temperature Sensor Bias
7	9	THERM	Cell Temperature Sensor Input
8	10	TIMER	Timer Set
9	11	$V_{SS3}$	Battery Management 0V Reference
10	12	$V_{BAT1}$	Battery Charge Control Output
11	13	$V_{BAT2}$	Battery Charge Control Output
12	14	$V_{BAT3}$	Battery Voltage Sense
13	15	$V_{SS2}$	Battery Management 0V Reference
14	16	EN	Logic Enable
15	1	STAT2	Fault Status Output
16	2	STAT1	Charge Status Output
17	–	EP	Exposed Pad; Battery Management 0V Reference

### 3.1 Voltage Regulation Selection ( $V_{SET}$ )

**MCP73861/3:** Connect  $V_{SET}$  to  $V_{SS}$  for 4.1V regulation voltage, connect to  $V_{DD}$  for 4.2V regulation voltage.

**MCP73862/4:** Connect  $V_{SET}$  to  $V_{SS}$  for 8.2V regulation voltage, connect to  $V_{DD}$  for 8.4V regulation voltage.

### 3.2 Battery Management Input Supply ( $V_{DD2}$ , $V_{DD1}$ )

A supply voltage of  $[V_{REG} \text{ (typ.)} + 0.3V]$  to 12V is recommended. Bypass to  $V_{SS}$  with a minimum of 4.7  $\mu F$ . A 1.5 k $\Omega$  resistor should be connected from  $V_{DD}$  to ground when using disconnectable supplies to force  $V_{DD} < V_{BAT}$  when the supply is disconnected and assure low leakage current.

### 3.3 Battery Management 0V Reference ( $V_{SS1}$ , $V_{SS2}$ , $V_{SS3}$ )

Connect to negative terminal of battery and input supply.

### 3.4 Current Regulation Set (PROG)

Preconditioning, fast and termination currents are scaled by placing a resistor from PROG to  $V_{SS}$ .

### 3.5 Cell Temperature Sensor Bias (THREF)

THREF is a voltage reference to bias external thermistor for continuous cell temperature monitoring and prequalification.

### 3.6 Cell Temperature Sensor Input (THERM)

THERM is an input for an external thermistor for continuous cell-temperature monitoring and prequalification. Connect to THREF/3 to disable temperature sensing.

### 3.7 Timer Set

All safety timers are scaled by  $C_{TIMER}/0.1 \mu F$ .

### 3.8 Battery Charge Control Output ( $V_{BAT1}$ , $V_{BAT2}$ )

Connect to positive terminal of battery. Drain terminal of internal P-channel MOSFET pass transistor. Bypass to  $V_{SS}$  with a minimum of 4.7  $\mu F$  to ensure loop stability when the battery is disconnected.

### 3.9 Battery Voltage Sense ( $V_{BAT3}$ )

$V_{BAT3}$  is a voltage sense input. Connect to positive terminal of battery. A precision internal resistor divider regulates the final voltage on this pin to  $V_{REG}$ .

# MCP73861/2/3/4

---

## 3.10 Logic Enable (EN)

EN is an input to force charge termination, initiate charge, clear faults or disable automatic recharge.

## 3.11 Fault Status Output (STAT2)

STAT2 is a current-limited, open-drain drive for direct connection to a LED for charge status indication. Alternatively, a pull-up resistor can be applied for interfacing to a host microcontroller.

## 3.12 Charge Status Output (STAT1)

STAT1 is a current-limited, open-drain drive for direct connection to a LED for charge status indication. Alternatively, a pull-up resistor can be applied for interfacing to a host microcontroller.

## 3.13 Exposed Pad (EP)

There is an internal electrical connection between the exposed thermal pad and  $V_{SS}$ . The EP must be connected to the same potential as the  $V_{SS}$  pin on the Printed Circuit Board (PCB).

## 4.0 DEVICE OVERVIEW

The MCP7386X family of devices are highly advanced linear charge management controllers. Refer to the functional block diagram. [Figure 4-2](#) depicts the operational flow algorithm from charge initiation to completion and automatic recharge.

### 4.1 Charge Qualification and Preconditioning

Upon insertion of a battery, or application of an external supply, the MCP7386X family of devices automatically performs a series of safety checks to qualify the charge. The input source voltage must be above the Undervoltage Lockout (UVLO) threshold, the enable pin must be above the logic-high level and the cell temperature must be within the upper and lower thresholds. The qualification parameters are continuously monitored. Deviation beyond the limits automatically suspends or terminates the charge cycle. The input voltage must deviate below the UVLO stop threshold for at least one clock period to be considered valid.

Once the qualification parameters have been met, the MCP7386X initiates a charge cycle. The charge status output is pulled low throughout the charge cycle (see [Table 5-1](#) for charge status outputs). If the battery voltage is below the preconditioning threshold ( $V_{PTH}$ ), the MCP7386X preconditions the battery with a trickle-charge. The preconditioning current is set to approximately 10% of the fast charge regulation current. The preconditioning trickle-charge safely replenishes deeply depleted cells and minimizes heat dissipation during the initial charge cycle. If the battery voltage has not exceeded the preconditioning threshold before the preconditioning timer has expired, a fault is indicated and the charge cycle is terminated.

### 4.2 Constant Current Regulation – Fast Charge

Preconditioning ends, and fast charging begins, when the battery voltage exceeds the preconditioning threshold. Fast charge regulates to a constant current ( $I_{REG}$ ), which is set via an external resistor connected to the PROG pin. Fast charge continues until the battery voltage reaches the regulation voltage ( $V_{REG}$ ), or the fast charge timer expires; in which case, a fault is indicated and the charge cycle is terminated.

### 4.3 Constant Voltage Regulation

When the battery voltage reaches the regulation voltage ( $V_{REG}$ ), constant voltage regulation begins. The MCP7386X monitors the battery voltage at the  $V_{BAT}$  pin. This input is tied directly to the positive terminal of the battery.

The MCP7386X selects the voltage regulation value based on the state of  $V_{SET}$ . With  $V_{SET}$  tied to  $V_{SS}$ , the MCP73861/3 and MCP73862/4 regulate to 4.1V and 8.2V, respectively. With  $V_{SET}$  tied to  $V_{DD}$ , the MCP73861/3 and MCP73862/4 regulate to 4.2V and 8.4V, respectively.

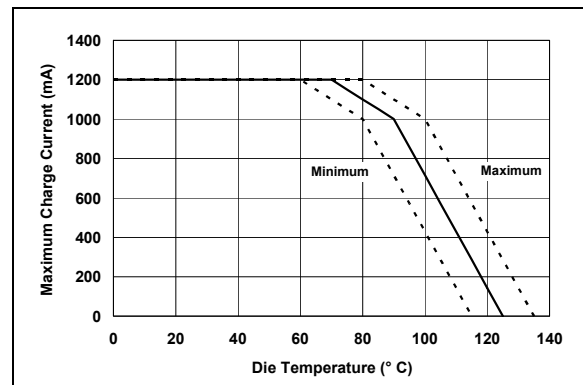
### 4.4 Charge Cycle Completion and Automatic Re-Charge

The MCP7386X monitors the charging current during the Constant-voltage regulation mode. The charge cycle is considered complete when the charge current has diminished below approximately 8% of the regulation current ( $I_{REG}$ ), or the elapsed timer has expired.

The MCP7386X automatically begins a new charge cycle when the battery voltage falls below the recharge threshold ( $V_{RTH}$ ), assuming all the qualification parameters are met.

### 4.5 Thermal Regulation

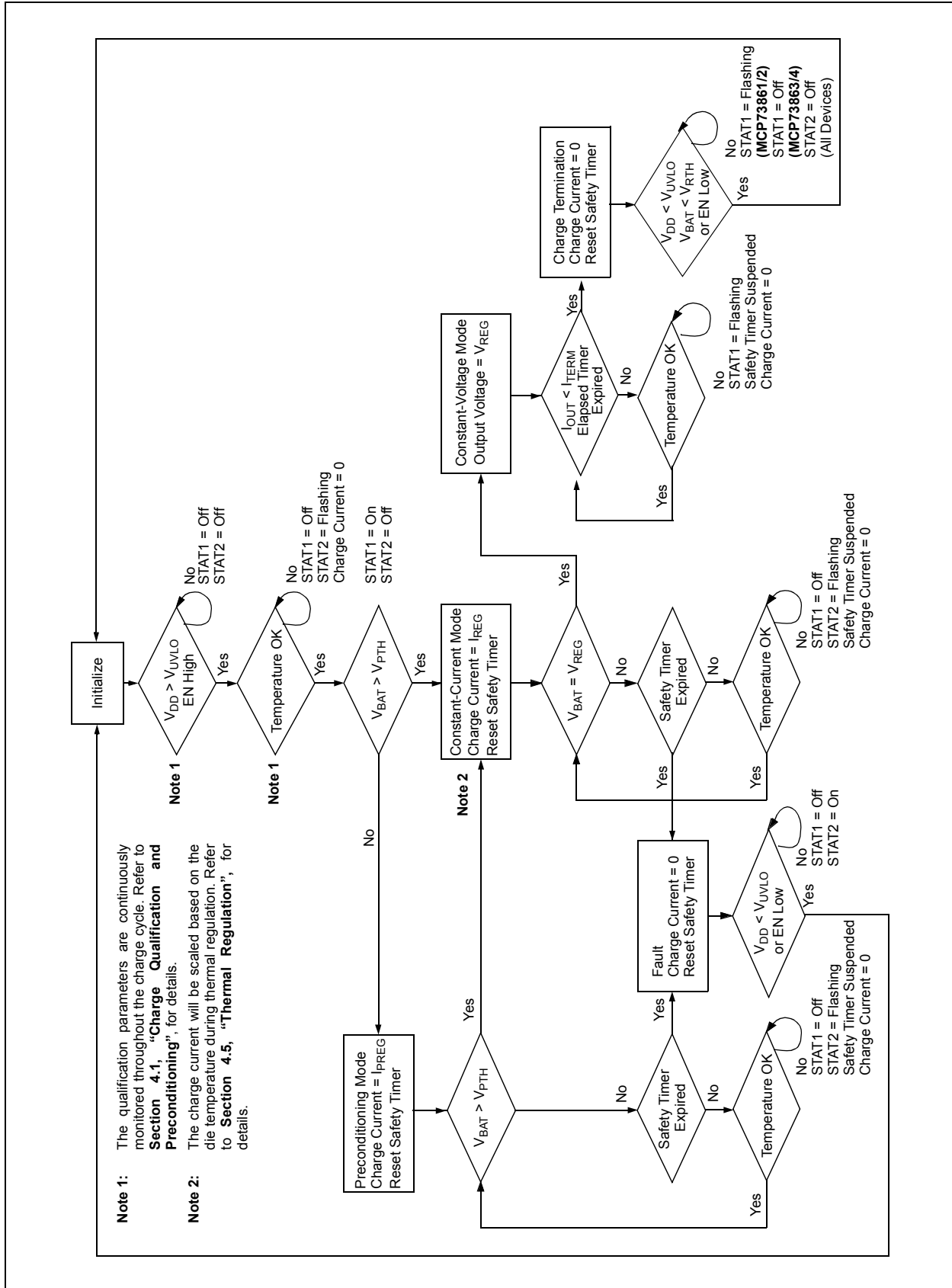
The MCP7386X family limits the charge current based on the die temperature. Thermal regulation optimizes the charge cycle time while maintaining device reliability. If thermal regulation is entered, the timer is automatically slowed down to ensure that a charge cycle will not terminate prematurely. [Figure 4-1](#) depicts the thermal regulation profile.



**FIGURE 4-1:** Typical Maximum Charge Current vs. Die Temperature.

### 4.6 Thermal Shutdown

The MCP7386X family suspends charge if the die temperature exceeds 155°C. Charging will resume when the die temperature has cooled by approximately 10°C. The thermal shutdown is a secondary safety feature in the event that there is a failure within the thermal regulation circuitry.



**FIGURE 4-2:** Operational Flow Algorithm.



## 5.0 DETAILED DESCRIPTION

### 5.1 Analog Circuitry

#### 5.1.1 BATTERY MANAGEMENT INPUT SUPPLY ( $V_{DD1}$ , $V_{DD2}$ )

The  $V_{DD}$  input is the input supply to the MCP7386X. The MCP7386X automatically enters a Power-down mode if the voltage on the  $V_{DD}$  input falls below the UVLO voltage ( $V_{STOP}$ ). This feature prevents draining the battery pack when the  $V_{DD}$  supply is not present. The  $V_{DD}$  inputs should be tied to ground with a resistor  $\leq 1.5\text{ k}\Omega$  to prevent  $V_{DD}$  from floating and staying at  $V_{BAT}$  level if the input supply is disconnected. The resistor will assure that  $V_{DD} < V_{BAT}$  when the input supply is removed.

#### 5.1.2 PROG INPUT

Fast charge current regulation can be scaled by placing a programming resistor ( $R_{PROG}$ ) from the PROG input to  $V_{SS}$ . Connecting the PROG input to  $V_{SS}$  allows for a maximum fast charge current of 1.2A, typically. The minimum fast charge current is 100 mA, set by letting the PROG input float. The following formula calculates the value for  $R_{PROG}$ :

$$R_{PROG} = \frac{13.2 - 11 \times I_{REG}}{12 \times I_{REG} - 1.2}$$

Where:

$I_{REG}$  = the desired fast charge current in amps.

$R_{PROG}$  = measured in  $\text{k}\Omega$ .

The preconditioning trickle-charge current and the charge termination current are scaled to approximately 10% and 8% of  $I_{REG}$  respectively.

#### 5.1.3 CELL TEMPERATURE SENSOR BIAS (THREF)

A 2.5V voltage reference is provided to bias an external thermistor for continuous cell temperature monitoring and prequalification. A ratio metric window comparison is performed at threshold levels of  $V_{THREF}/2$  and  $V_{THREF}/4$ .

#### 5.1.4 CELL TEMPERATURE SENSOR INPUT (THERM)

The MCP73861/2/3/4 continuously monitors temperature by comparing the voltage between the THERM input and  $V_{SS}$  with the upper and lower temperature thresholds. A negative or positive temperature coefficient, NTC or PTC thermistor and an external voltage-divider typically develop this voltage. The temperature sensing circuit has its own reference to which it performs a ratio metric comparison. Therefore, it is immune to fluctuations in the supply input ( $V_{DD}$ ). The

temperature-sensing circuit is removed from the system when  $V_{DD}$  is not applied, eliminating additional discharge of the battery pack.

Figure 6-1 depicts a typical application circuit with connection of the THERM input. The resistor values of  $R_{T1}$  and  $R_{T2}$  are calculated with the following equations.

For NTC thermistors:

$$R_{T1} = \frac{2 \times R_{COLD} \times R_{HOT}}{R_{COLD} - R_{HOT}}$$

$$R_{T2} = \frac{2 \times R_{COLD} \times R_{HOT}}{R_{COLD} - 3 \times R_{HOT}}$$

For PTC thermistors:

$$R_{T1} = \frac{2 \times R_{COLD} \times R_{HOT}}{R_{HOT} - R_{COLD}}$$

$$R_{T2} = \frac{2 \times R_{COLD} \times R_{HOT}}{R_{HOT} - 3 \times R_{COLD}}$$

Where:

$R_{COLD}$  and  $R_{HOT}$  are the thermistor resistance values at the temperature window of interest.

Applying a voltage equal to  $V_{THREF}/3$  to the THERM input disables temperature monitoring.

#### 5.1.5 TIMER SET INPUT (TIMER)

The TIMER input programs the period of the safety timers by placing a timing capacitor ( $C_{TIMER}$ ) between the TIMER input pin and  $V_{SS}$ . Three safety timers are programmed via the timing capacitor.

The preconditioning safety timer period:

$$t_{PRECON} = \frac{C_{TIMER}}{0.1\mu F} \times 1.0\text{Hours}$$

The fast charge safety timer period:

$$t_{FAST} = \frac{C_{TIMER}}{0.1\mu F} \times 1.5\text{Hours}$$

The elapsed time termination period:

$$t_{TERM} = \frac{C_{TIMER}}{0.1\mu F} \times 3.0\text{Hours}$$

The preconditioning timer starts after qualification and resets when the charge cycle transitions to the fast charge, Constant-current mode. The fast charge timer and the elapsed timer start once the MCP7386X transitions from preconditioning. The fast charge timer resets when the charge cycle transitions to the Constant-voltage mode. The elapsed timer will expire and terminate the charge if the sensed current does not diminish below the termination threshold.

# MCP73861/2/3/4

During thermal regulation, the timer is slowed down proportional to the charge current.

## 5.1.6 BATTERY VOLTAGE SENSE ( $V_{BAT3}$ )

The MCP7386X monitors the battery voltage at the  $V_{BAT3}$  pin. This input is tied directly to the positive terminal of the battery pack.

## 5.1.7 BATTERY CHARGE CONTROL OUTPUT ( $V_{BAT1}$ , $V_{BAT2}$ )

The battery charge control output is the drain terminal of an internal P-channel MOSFET. The MCP7386X provides constant current and voltage regulation to the battery pack by controlling this MOSFET in the linear region. The battery charge control output should be connected to the positive terminal of the battery pack.

## 5.2 Digital Circuitry

### 5.2.1 CHARGE STATUS OUTPUTS (STAT1, STAT2)

Two status outputs provide information on the state of charge. The current-limited, open-drain outputs can be used to illuminate external LEDs. Optionally, a pull-up resistor can be used on the output for communication with a host microcontroller. [Table 5-1](#) summarizes the state of the status outputs during a charge cycle.

**TABLE 5-1: STATUS OUTPUTS**

CHARGE CYCLE STAT1	STAT1	STAT2
Qualification	Off	Off
Preconditioning	On	Off
Constant-Current Fast Charge	On	Off
Constant-Voltage	On	Off
Charge Complete	Flashing (1 Hz, 50% duty cycle) (MCP73861/2)	Off (All Devices)
	Off (MCP73863/4)	
Fault	Off	On
THERM Invalid	Off	Flashing (1 Hz 50% duty cycle)
Disabled – Sleep mode	Off	Off
Input Voltage Disconnected (1.5K $\Omega$ Pulldown)	Off	Off

**Legend:** Off state: Open-drain is high-impedance  
 On state: Open-drain can sink current typically 7 mA  
 Flashing: Toggles between off state and on state

The flashing rate (1 Hz) is based off a timer capacitor ( $C_{TIMER}$ ) of 0.1  $\mu$ F. The rate will vary based on the value of the timer capacitor.

During a Fault condition, the STAT1 status output will be off and the STAT2 status output will be on. To recover from a Fault condition, the input voltage must be removed and then reapplied, or the enable input (EN) must be de-asserted to a logic-low, then asserted to a logic-high.

When the voltage on the THERM input is outside the preset window, the charge cycle will not start, or will be suspended. The charge cycle is not terminated and recovery is automatic. The charge cycle will resume (or start) once the THERM input is valid and all other qualification parameters are met. During an invalid THERM condition, the STAT1 status output will be off and the STAT2 status output will flash.

### 5.2.2 $V_{SET}$ INPUT

The  $V_{SET}$  input selects the regulated output voltage of the MCP7386X. With  $V_{SET}$  tied to  $V_{SS}$ , the MCP73861/3 and MCP73862/4 regulate to 4.1V and 8.2V, respectively. With  $V_{SET}$  tied to  $V_{DD}$ , the MCP73861/3 and MCP73862/4 regulate to 4.2V and 8.4V, respectively.

### 5.2.3 LOGIC ENABLE (EN)

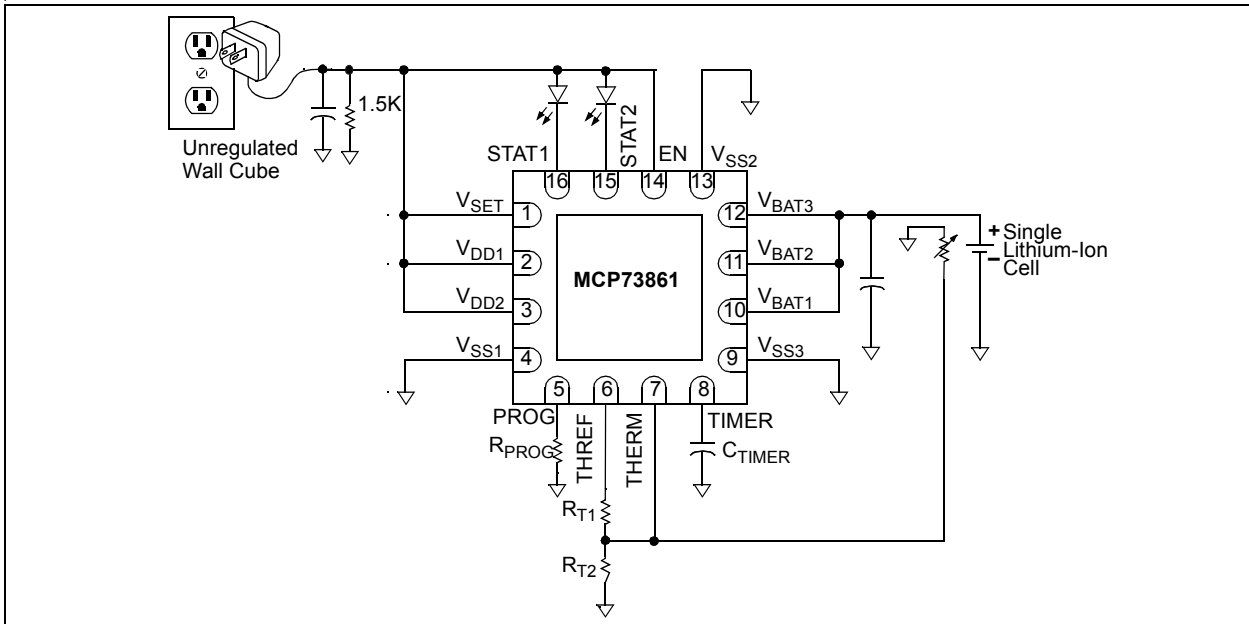
The logic enable input pin (EN) can be used to terminate a charge at any time during the charge cycle, as well as to initiate a charge cycle or initiate a recharge cycle.

Applying a logic-high input signal to the EN pin, or tying it to the input source, enables the device. Applying a logic-low input signal disables the device and terminates a charge cycle. When disabled, the device's supply current is reduced to 0.17  $\mu$ A, typically.

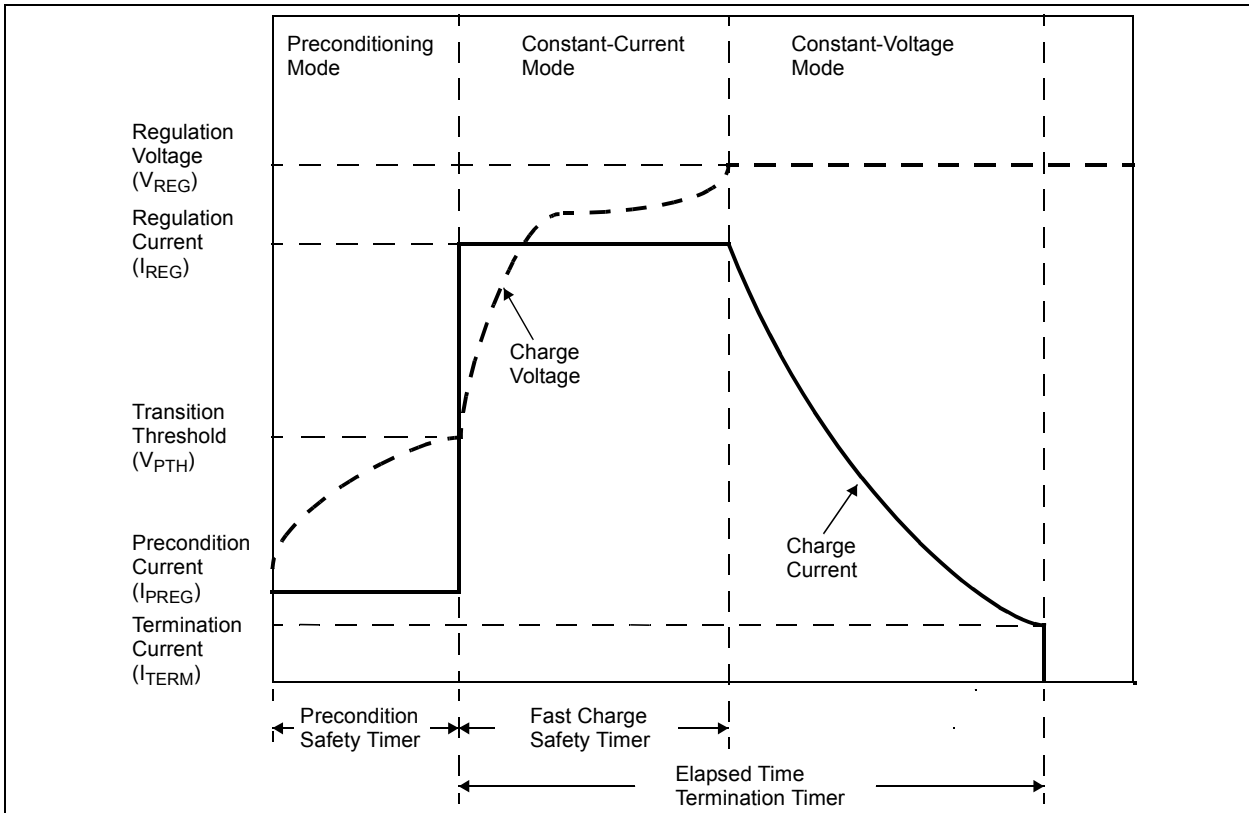
## 6.0 APPLICATIONS

The MCP7386X is designed to operate in conjunction with a host microcontroller or in stand-alone applications. The MCP7386X provides the preferred charge algorithm for Lithium-Ion and Lithium-Polymer cells Constant-current followed by Constant-voltage.

Figure 6-1 illustrates a typical stand-alone application circuit, while Figures 6-2 and 6-3 illustrate the accompanying charge profile

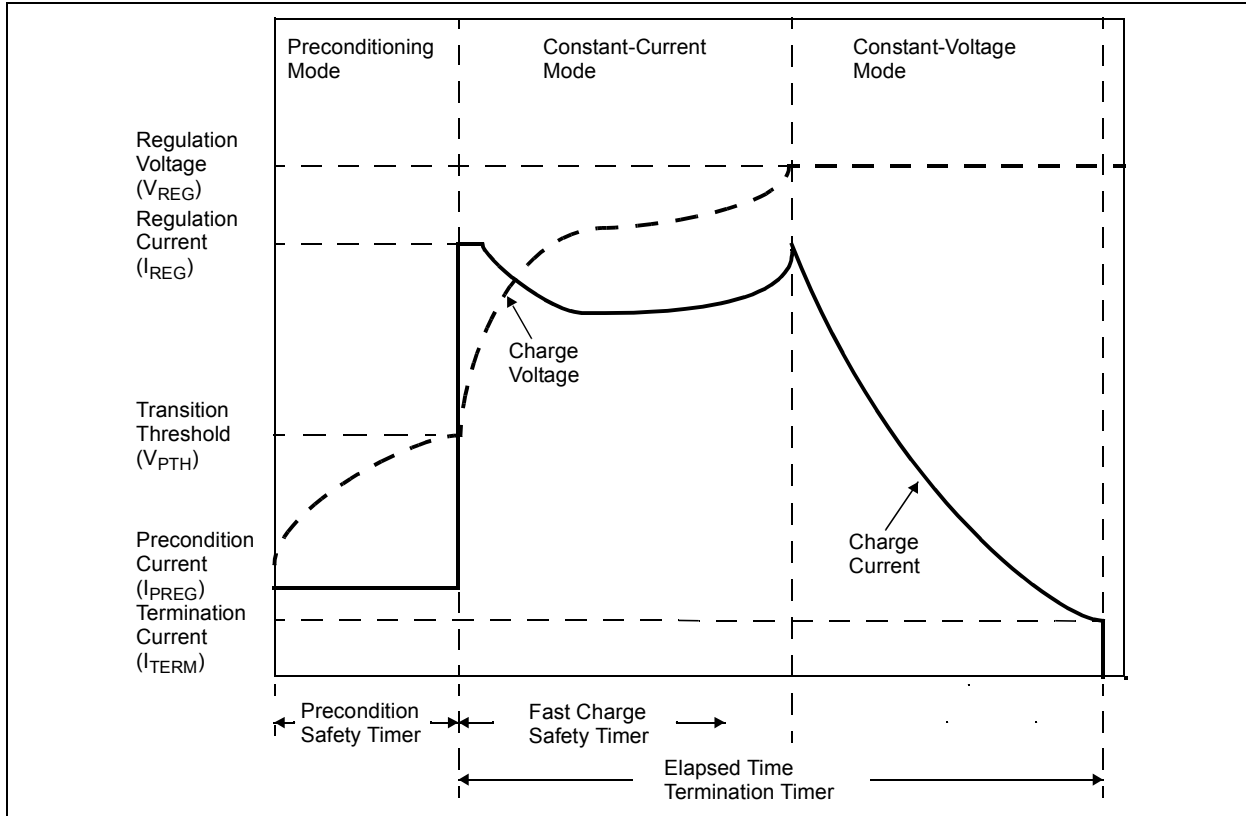


**FIGURE 6-1:** Typical Application Circuit.



**FIGURE 6-2:** Typical Charge Profile.

# MCP73861/2/3/4



**FIGURE 6-3:** Typical Charge Profile in Thermal Regulation.

## 6.1 Application Circuit Design

Due to the low efficiency of linear charging, the most important factors are thermal design and cost, which are a direct function of the input voltage, output current and thermal impedance between the battery charger and the ambient cooling air. The worst-case situation is when the device has transitioned from the Preconditioning mode to the Constant-current mode. In this situation, the battery charger has to dissipate the maximum power. A trade-off must be made between the charge current, cost and thermal requirements of the charger.

### 6.1.1 COMPONENT SELECTION

Selection of the external components in [Figure 6-1](#) is crucial to the integrity and reliability of the charging system. The following discussion is intended as a guide for the component selection process.

#### 6.1.1.1 Current Programming Resistor (R<sub>PROG</sub>)

The preferred fast charge current for Lithium-Ion cells is at the 1C rate, with an absolute maximum current at the 2C rate. For example, a 500 mAh battery pack has a preferred fast charge current of 500 mA. Charging at this rate provides the shortest charge cycle times without degradation to the battery pack performance or life.

1200 mA is the maximum charge current obtainable from the MCP7386X. For this situation, the PROG input should be connected directly to V<sub>SS</sub>.

#### 6.1.1.2 Thermal Considerations

The worst-case power dissipation in the battery charger occurs when the input voltage is at the maximum and the device has transitioned from the Preconditioning mode to the Constant-current mode. In this case, the power dissipation is:

$$PowerDissipation = (V_{DDMAX} - V_{PTHMIN}) \times I_{REGMAX}$$

Where:

- V<sub>DDMAX</sub> = the maximum input voltage
- I<sub>REGMAX</sub> = the maximum fast charge current
- V<sub>PTHMIN</sub> = the minimum transition threshold voltage

Power dissipation with a 5V, ±10% input voltage source is:

$$PowerDissipation = (5.5V - 2.7V) \times 575mA = 1.61W$$

With the battery charger mounted on a 1 in<sup>2</sup> pad of 1 oz. copper, the junction temperature rise is 60°C, approximately. This would allow for a maximum operating ambient temperature of 50°C before thermal regulation is entered.

### 6.1.1.3 External Capacitors

The MCP7386X is stable with or without a battery load. In order to maintain good AC stability in the Constant-voltage mode, a minimum capacitance of 4.7 µF is recommended to bypass the V<sub>BAT</sub> pin to V<sub>SS</sub>. This capacitance provides compensation when there is no battery load. In addition, the battery and interconnections appear inductive at high frequencies. These elements are in the control feedback loop during Constant-voltage mode. Therefore, the bypass capacitance may be necessary to compensate for the inductive nature of the battery pack.

Virtually any good quality output filter capacitor can be used, independent of the capacitor's minimum Effective Series Resistance (ESR) value. The actual value of the capacitor (and its associated ESR) depends on the output load current. A 4.7 µF ceramic, tantalum or aluminum electrolytic capacitor at the output is usually sufficient to ensure stability for up to a 1A output current.

### 6.1.1.4 Reverse-Blocking Protection

The MCP7386X provides protection from a faulted or shorted input, or from a reversed-polarity input source. Without the protection, a faulted or shorted input would discharge the battery pack through the body diode of the internal pass transistor.

### 6.1.1.5 Enable Interface

In the stand-alone configuration, the enable pin is generally tied to the input voltage. The MCP7386X automatically enters a Low-power mode when voltage on the V<sub>DD</sub> input falls below the UVLO voltage (V<sub>STOP</sub>), reducing the battery drain current to 0.23 µA, typically.

### 6.1.1.6 Charge Status Interface

Two status outputs provide information on the state of charge. The current-limited, open-drain outputs can be used to illuminate external LEDs. Refer to [Table 5-1](#) for a summary of the state of the status outputs during a charge cycle.

## 6.2 PCB Layout Issues

For optimum voltage regulation, place the battery pack as close as possible to the device's V<sub>BAT</sub> and V<sub>SS</sub> pins, recommended to minimize voltage drops along the high current-carrying PCB traces.

If the PCB layout is used as a heatsink, adding many vias in the heatsink pad can help conduct more heat to the backplane of the PCB, thus reducing the maximum junction temperature.

# MCP73861/2/3/4

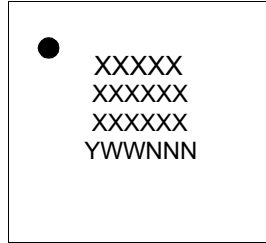
---

NOTES:

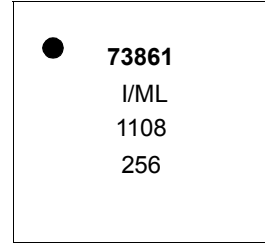
## 7.0 PACKAGING INFORMATION

### 7.1 Package Marking Information

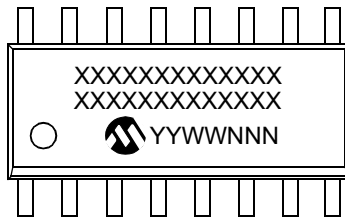
16-Lead QFN



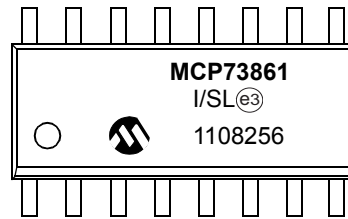
Example:



16-Lead SOIC (150 mil)



Example:



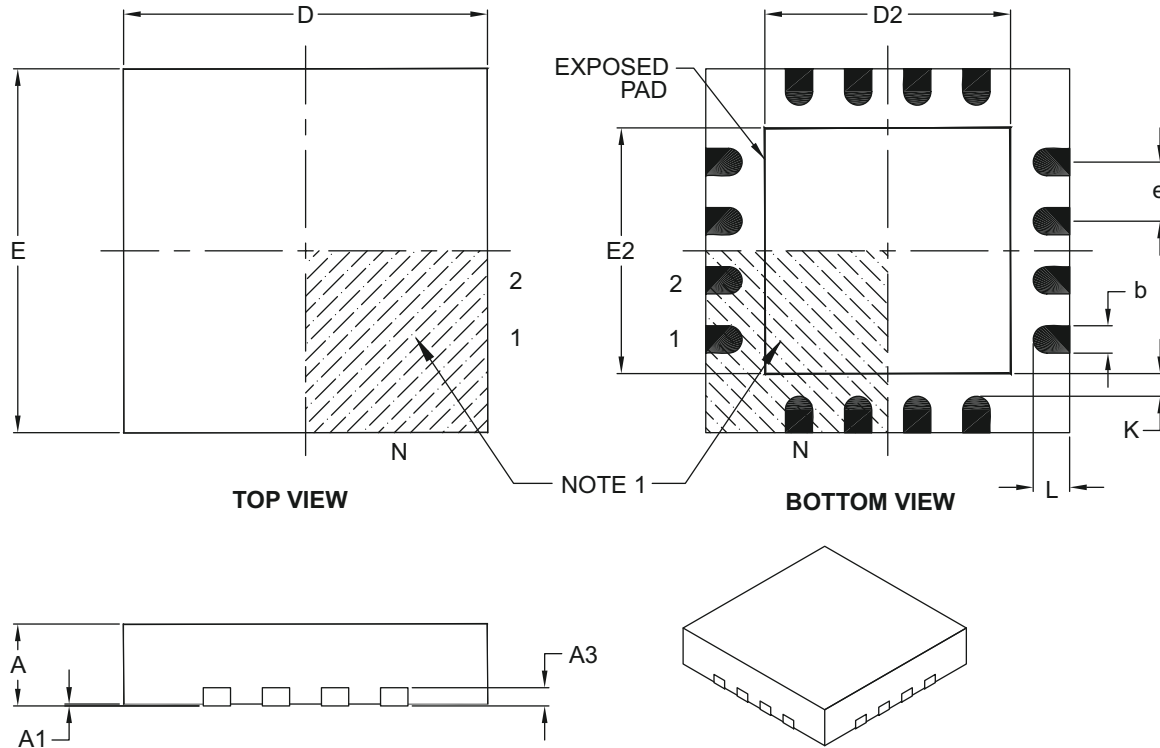
<b>Legend:</b>	XX...X	Customer-specific information
	Y	Year code (last digit of calendar year)
	YY	Year code (last 2 digits of calendar year)
	WW	Week code (week of January 1 is week '01')
	NNN	Alphanumeric traceability code
	(e3)	Pb-free JEDEC designator for Matte Tin (Sn)
	*	This package is Pb-free. The Pb-free JEDEC designator (e3) can be found on the outer packaging for this package.

**Note:** In the event the full Microchip part number cannot be marked on one line, it will be carried over to the next line, thus limiting the number of available characters for customer-specific information.

# MCP73861/2/3/4

## 16-Lead Plastic Quad Flat, No Lead Package (ML) – 4x4x0.9 mm Body [QFN]

**Note:** For the most current package drawings, please see the Microchip Packaging Specification located at <http://www.microchip.com/packaging>



Dimension Limits	Units	MILLIMETERS		
		MIN	NOM	MAX
Number of Pins	N	16		
Pitch	e	0.65 BSC		
Overall Height	A	0.80	0.90	1.00
Standoff	A1	0.00	0.02	0.05
Contact Thickness	A3	0.20 REF		
Overall Width	E	4.00 BSC		
Exposed Pad Width	E2	2.50	2.65	2.80
Overall Length	D	4.00 BSC		
Exposed Pad Length	D2	2.50	2.65	2.80
Contact Width	b	0.25	0.30	0.35
Contact Length	L	0.30	0.40	0.50
Contact-to-Exposed Pad	K	0.20	–	–

**Notes:**

- Pin 1 visual index feature may vary, but must be located within the hatched area.
- Package is saw singulated.
- Dimensioning and tolerancing per ASME Y14.5M.

BSC: Basic Dimension. Theoretically exact value shown without tolerances.

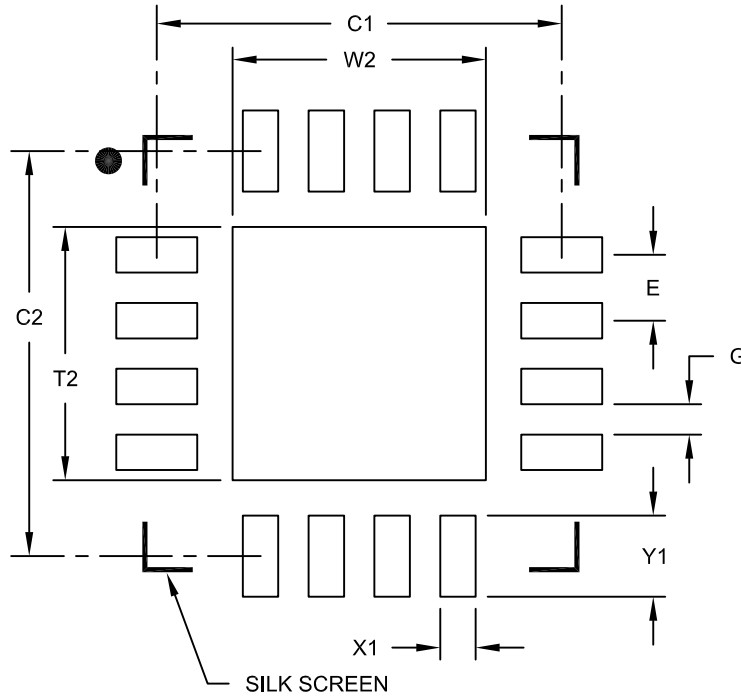
REF: Reference Dimension, usually without tolerance, for information purposes only.

Microchip Technology Drawing C04-127B



## 16-Lead Plastic Quad Flat, No Lead Package (ML) - 4x4x0.9mm Body [QFN]

**Note:** For the most current package drawings, please see the Microchip Packaging Specification located at <http://www.microchip.com/packaging>



RECOMMENDED LAND PATTERN

Dimension Limits	Units	MILLIMETERS		
		MIN	NOM	MAX
Contact Pitch	E	0.65 BSC		
Optional Center Pad Width	W2			2.50
Optional Center Pad Length	T2			2.50
Contact Pad Spacing	C1		4.00	
Contact Pad Spacing	C2		4.00	
Contact Pad Width (X16)	X1			0.35
Contact Pad Length (X16)	Y1			0.80
Distance Between Pads	G	0.30		

**Notes:**

1. Dimensioning and tolerancing per ASME Y14.5M

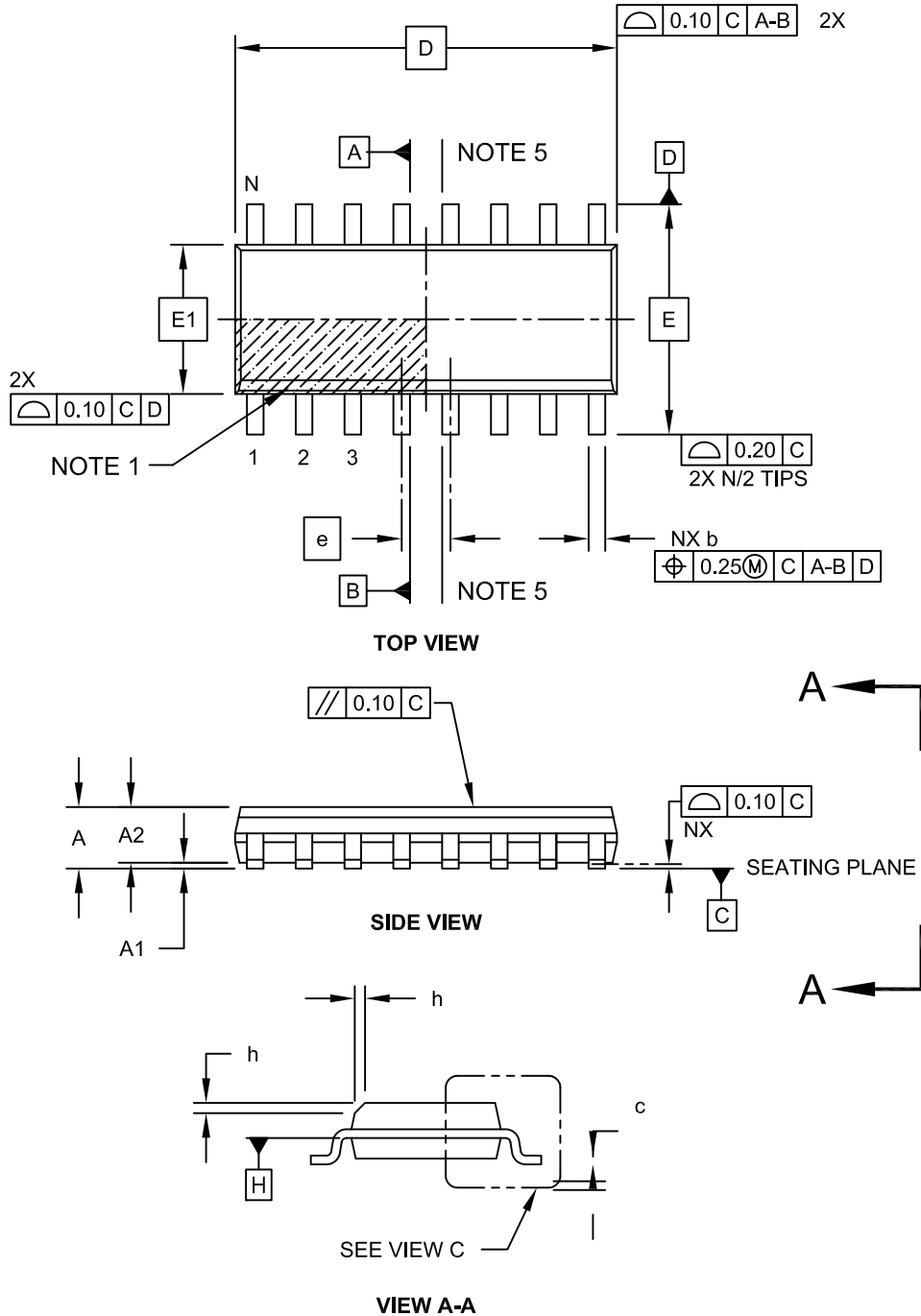
BSC: Basic Dimension. Theoretically exact value shown without tolerances.

Microchip Technology Drawing No. C04-2127A

# MCP73861/2/3/4

## 16-Lead Plastic Small Outline (SL) - Narrow, 3.90 mm Body [SOIC]

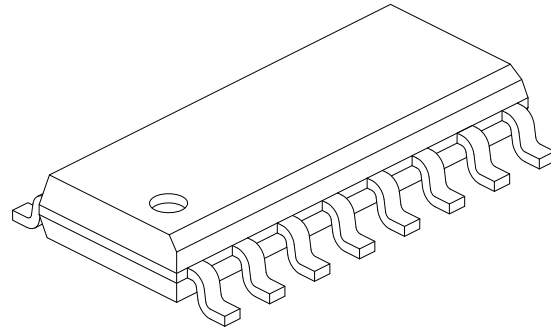
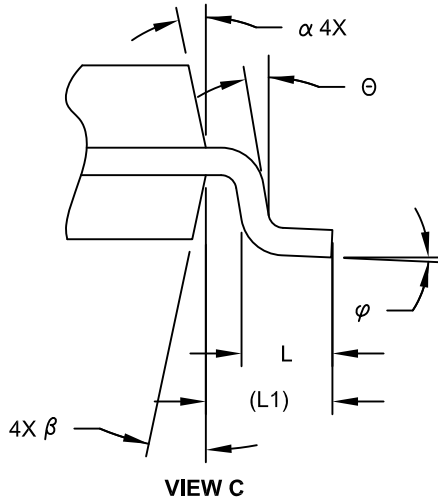
**Note:** For the most current package drawings, please see the Microchip Packaging Specification located at <http://www.microchip.com/packaging>



Microchip Technology Drawing No. C04-108C Sheet 1 of 2

## 16-Lead Plastic Small Outline (SL) - Narrow, 3.90 mm Body [SOIC]

**Note:** For the most current package drawings, please see the Microchip Packaging Specification located at <http://www.microchip.com/packaging>



Dimension Limits	Units	MILLIMETERS		
		MIN	NOM	MAX
Number of Pins	N	16		
Pitch	e	1.27 BSC		
Overall Height	A	-	-	1.75
Molded Package Thickness	A2	1.25	-	-
Standoff §	A1	0.10	-	0.25
Overall Width	E	6.00 BSC		
Molded Package Width	E1	3.90 BSC		
Overall Length	D	9.90 BSC		
Chamfer (Optional)	h	0.25	-	0.50
Foot Length	L	0.40	-	1.27
Footprint	L1	1.04 REF		
Lead Angle	$\Theta$	0°	-	-
Foot Angle	$\varphi$	0°	-	8°
Lead Thickness	c	0.10	-	0.25
Lead Width	b	0.31	-	0.51
Mold Draft Angle Top	$\alpha$	5°	-	15°
Mold Draft Angle Bottom	$\beta$	5°	-	15°

**Notes:**

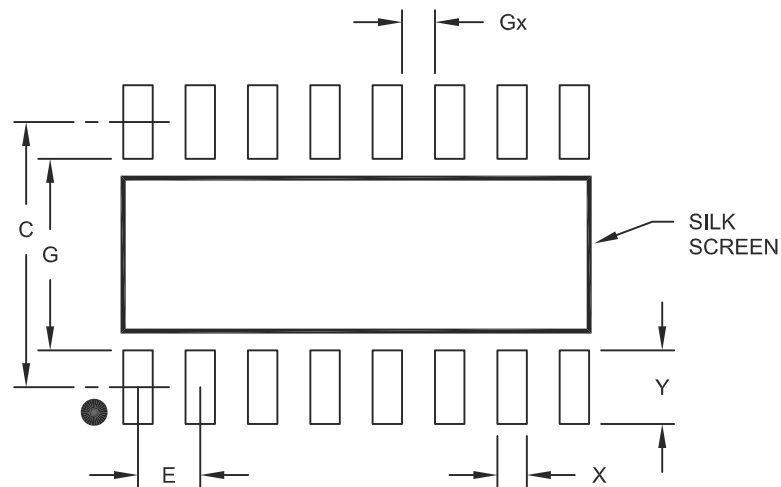
- Pin 1 visual index feature may vary, but must be located within the hatched area.
- § Significant Characteristic
- Dimension D does not include mold flash, protrusions or gate burrs, which shall not exceed 0.15 mm per end. Dimension E1 does not include interlead flash or protrusion, which shall not exceed 0.25 mm per side.
- Dimensioning and tolerancing per ASME Y14.5M  
 BSC: Basic Dimension. Theoretically exact value shown without tolerances.  
 REF: Reference Dimension, usually without tolerance, for information purposes only.
- Datums A & B to be determined at Datum H.

Microchip Technology Drawing No. C04-108C Sheet 2 of 2

# MCP73861/2/3/4

16-Lead Plastic Small Outline (SL) - Narrow, 3.90 mm Body [SOIC]

**Note:** For the most current package drawings, please see the Microchip Packaging Specification located at <http://www.microchip.com/packaging>



## RECOMMENDED LAND PATTERN

Dimension Limits	Units	MILLIMETERS		
		MIN	NOM	MAX
Contact Pitch	E	1.27 BSC		
Contact Pad Spacing	C		5.40	
Contact Pad Width	X			0.60
Contact Pad Length	Y			1.50
Distance Between Pads	Gx	0.67		
Distance Between Pads	G	3.90		

Notes:

1. Dimensioning and tolerancing per ASME Y14.5M

BSC: Basic Dimension. Theoretically exact value shown without tolerances.

Microchip Technology Drawing No. C04-2108A

## APPENDIX A: REVISION HISTORY

### Revision F (March 2013)

The following is the list of modifications:

1. Added the Output Reverse Leakage Switchover Time parameter to the DC Characteristics table.
2. Updated Section 3.2.
3. Updated Section 5.1.1.
4. Updated [Figure 6-1](#).

### Revision E (April 2011)

The following is the list of modifications:

1. Updated [Figure 2-4](#).

### Revision D (December 2008)

The following is the list of modifications:

1. Updated package outline diagrams.

### Revision C (August 2005)

The following is the list of modifications:

1. Added MCP73863 and MCP73864 devices throughout data sheet.
2. Added Appendix A: Revision History.
3. Updated QFN and SOIC package diagrams.

### Revision B (December 2004)

The following is the list of modifications:

Added SOIC package throughout data sheet.

### Revision A (June 2004)

Original Release of this Document.

# MCP73861/2/3/4

---

NOTES:

## PRODUCT IDENTIFICATION SYSTEM

To order or obtain information, e.g., on pricing or delivery, contact the Microchip sales office.

<u>PART NO.</u>		<u>X</u>	<u>/XX</u>	<b>Examples:</b>	
<b>Device</b>	<b>Temperature Range</b>		<b>Package</b>		
<b>Device:</b>	MCP73861:	Single-Cell Charge Controller with Temperature Monitor		a)	MCP73861-I/ML: Single-Cell Controller 16LD-QFN package.
	MCP73861T:	Single-Cell Charge Controller with Temperature Monitor, Tape and Reel		b)	MCP73861T-I/ML: Tape and Reel, Single-Cell Controller 16LD-QFN package.
	MCP73862:	Dual Series Cells Charge Controller with Temperature Monitor		c)	MCP73861-I/SL: Single-Cell Controller 16LD-SOIC package.
	MCP73862T:	Dual Series Cells Charge Controller with Temperature Monitor, Tape and Reel		d)	MCP73861T-I/SL: Tape and Reel, Single-Cell Controller 16LD-SOIC package.
	MCP73863:	Single-cell Charge Controller with Temperature Monitor		a)	MCP73862-I/ML: Dual-Cell Controller 16LD-QFN package.
	MCP73863T:	Single-Cell Charge Controller with Temperature Monitor, Tape and Reel		b)	MCP73862T-I/ML: Tape and Reel, Dual-Cell Controller 16LD-QFN package.
	MCP73864:	Dual Series Cells Charge Controller with Temperature Monitor		c)	MCP73862-I/SL: Dual-Cell Controller 16LD-SOIC package.
	MCP73864T:	Dual Series Cells Charge Controller with Temperature Monitor, Tape and Reel		d)	MCP73862T-I/SL: Tape and Reel, Dual-Cell Controller 16LD-SOIC package.
<b>Temperature Range:</b>	I	= -40°C to +85°C (Industrial)		a)	MCP73863-I/ML: Single-Cell Controller 16LD-QFN package.
<b>Package:</b>	ML	= Plastic Quad Flat No Lead, 4x4 mm Body (QFN), 16-lead		b)	MCP73863T-I/ML: Tape and Reel, Single-Cell Controller 16LD-QFN package.
	SL	= Plastic Small Outline, 150 mm Body (SOIC), 16-lead		c)	MCP73863-I/SL: Single-Cell Controller 16LD-SOIC package.
				d)	MCP73863T-I/SL: Tape and Reel, Single-Cell Controller 16LD-SOIC package.
				a)	MCP73864-I/ML: Dual-Cell Controller 16LD-QFN package.
				b)	MCP73864T-I/ML: Tape and Reel, Dual-Cell Controller 16LD-QFN package.
				c)	MCP73864-I/SL: Dual-Cell Controller 16LD-SOIC package.
				d)	MCP73864T-I/SL: Tape and Reel, Dual-Cell Controller 16LD-SOIC package.

# MCP73861/2/3/4

---

NOTES:



---

**Note the following details of the code protection feature on Microchip devices:**

- Microchip products meet the specification contained in their particular Microchip Data Sheet.
- Microchip believes that its family of products is one of the most secure families of its kind on the market today, when used in the intended manner and under normal conditions.
- There are dishonest and possibly illegal methods used to breach the code protection feature. All of these methods, to our knowledge, require using the Microchip products in a manner outside the operating specifications contained in Microchip's Data Sheets. Most likely, the person doing so is engaged in theft of intellectual property.
- Microchip is willing to work with the customer who is concerned about the integrity of their code.
- Neither Microchip nor any other semiconductor manufacturer can guarantee the security of their code. Code protection does not mean that we are guaranteeing the product as “unbreakable.”

Code protection is constantly evolving. We at Microchip are committed to continuously improving the code protection features of our products. Attempts to break Microchip's code protection feature may be a violation of the Digital Millennium Copyright Act. If such acts allow unauthorized access to your software or other copyrighted work, you may have a right to sue for relief under that Act.

---

Information contained in this publication regarding device applications and the like is provided only for your convenience and may be superseded by updates. It is your responsibility to ensure that your application meets with your specifications. MICROCHIP MAKES NO REPRESENTATIONS OR WARRANTIES OF ANY KIND WHETHER EXPRESS OR IMPLIED, WRITTEN OR ORAL, STATUTORY OR OTHERWISE, RELATED TO THE INFORMATION, INCLUDING BUT NOT LIMITED TO ITS CONDITION, QUALITY, PERFORMANCE, MERCHANTABILITY OR FITNESS FOR PURPOSE. Microchip disclaims all liability arising from this information and its use. Use of Microchip devices in life support and/or safety applications is entirely at the buyer's risk, and the buyer agrees to defend, indemnify and hold harmless Microchip from any and all damages, claims, suits, or expenses resulting from such use. No licenses are conveyed, implicitly or otherwise, under any Microchip intellectual property rights.

**Trademarks**

The Microchip name and logo, the Microchip logo, dsPIC, FlashFlex, KEELOQ, KEELOQ logo, MPLAB, PIC, PICmicro, PICSTART, PIC<sup>32</sup> logo, rPIC, SST, SST Logo, SuperFlash and UNI/O are registered trademarks of Microchip Technology Incorporated in the U.S.A. and other countries.

FilterLab, Hampshire, HI-TECH C, Linear Active Thermistor, MTP, SEEVAL and The Embedded Control Solutions Company are registered trademarks of Microchip Technology Incorporated in the U.S.A.

Silicon Storage Technology is a registered trademark of Microchip Technology Inc. in other countries.

Analog-for-the-Digital Age, Application Maestro, BodyCom, chipKIT, chipKIT logo, CodeGuard, dsPICDEM, dsPICDEM.net, dsPICworks, dsSPEAK, ECAN, ECONOMONITOR, FanSense, HI-TIDE, In-Circuit Serial Programming, ICSP, Mindi, MiWi, MPASM, MPF, MPLAB Certified logo, MPLIB, MPLINK, mTouch, Omniclient Code Generation, PICC, PICC-18, PICDEM, PICDEM.net, PICkit, PICtail, REAL ICE, rFLAB, Select Mode, SQI, Serial Quad I/O, Total Endurance, TSHARC, UniWinDriver, WiperLock, ZENA and Z-Scale are trademarks of Microchip Technology Incorporated in the U.S.A. and other countries.

SQTP is a service mark of Microchip Technology Incorporated in the U.S.A.

GestIC and ULPP are registered trademarks of Microchip Technology Germany II GmbH & Co. KG, a subsidiary of Microchip Technology Inc., in other countries.

All other trademarks mentioned herein are property of their respective companies.

© 2004-2013, Microchip Technology Incorporated, Printed in the U.S.A., All Rights Reserved.

 Printed on recycled paper.

ISBN: 9781620770405

**QUALITY MANAGEMENT SYSTEM**  
**CERTIFIED BY DNV**  
**== ISO/TS 16949 ==**

*Microchip received ISO/TS-16949:2009 certification for its worldwide headquarters, design and wafer fabrication facilities in Chandler and Tempe, Arizona; Gresham, Oregon and design centers in California and India. The Company's quality system processes and procedures are for its PIC<sup>®</sup> MCUs and dsPIC<sup>®</sup> DSCs, KEELOQ<sup>®</sup> code hopping devices, Serial EEPROMs, microperipherals, nonvolatile memory and analog products. In addition, Microchip's quality system for the design and manufacture of development systems is ISO 9001:2000 certified.*



# MICROCHIP

## Worldwide Sales and Service

### AMERICAS

**Corporate Office**  
2355 West Chandler Blvd.  
Chandler, AZ 85224-6199  
Tel: 480-792-7200  
Fax: 480-792-7277  
Technical Support:  
<http://www.microchip.com/support>  
Web Address:  
[www.microchip.com](http://www.microchip.com)

**Atlanta**  
Duluth, GA  
Tel: 678-957-9614  
Fax: 678-957-1455

**Boston**  
Westborough, MA  
Tel: 774-760-0087  
Fax: 774-760-0088

**Chicago**  
Itasca, IL  
Tel: 630-285-0071  
Fax: 630-285-0075

**Cleveland**  
Independence, OH  
Tel: 216-447-0464  
Fax: 216-447-0643

**Dallas**  
Addison, TX  
Tel: 972-818-7423  
Fax: 972-818-2924

**Detroit**  
Farmington Hills, MI  
Tel: 248-538-2250  
Fax: 248-538-2260

**Indianapolis**  
Noblesville, IN  
Tel: 317-773-8323  
Fax: 317-773-5453

**Los Angeles**  
Mission Viejo, CA  
Tel: 949-462-9523  
Fax: 949-462-9608

**Santa Clara**  
Santa Clara, CA  
Tel: 408-961-6444  
Fax: 408-961-6445

**Toronto**  
Mississauga, Ontario,  
Canada  
Tel: 905-673-0699  
Fax: 905-673-6509

### ASIA/PACIFIC

**Asia Pacific Office**  
Suites 3707-14, 37th Floor  
Tower 6, The Gateway  
Harbour City, Kowloon  
Hong Kong  
Tel: 852-2401-1200  
Fax: 852-2401-3431

**Australia - Sydney**  
Tel: 61-2-9868-6733  
Fax: 61-2-9868-6755

**China - Beijing**  
Tel: 86-10-8569-7000  
Fax: 86-10-8528-2104

**China - Chengdu**  
Tel: 86-28-8665-5511  
Fax: 86-28-8665-7889

**China - Chongqing**  
Tel: 86-23-8980-9588  
Fax: 86-23-8980-9500

**China - Hangzhou**  
Tel: 86-571-2819-3187  
Fax: 86-571-2819-3189

**China - Hong Kong SAR**  
Tel: 852-2943-5100  
Fax: 852-2401-3431

**China - Nanjing**  
Tel: 86-25-8473-2460  
Fax: 86-25-8473-2470

**China - Qingdao**  
Tel: 86-532-8502-7355  
Fax: 86-532-8502-7205

**China - Shanghai**  
Tel: 86-21-5407-5533  
Fax: 86-21-5407-5066

**China - Shenyang**  
Tel: 86-24-2334-2829  
Fax: 86-24-2334-2393

**China - Shenzhen**  
Tel: 86-755-8864-2200  
Fax: 86-755-8203-1760

**China - Wuhan**  
Tel: 86-27-5980-5300  
Fax: 86-27-5980-5118

**China - Xian**  
Tel: 86-29-8833-7252  
Fax: 86-29-8833-7256

**China - Xiamen**  
Tel: 86-592-2388138  
Fax: 86-592-2388130

**China - Zhuhai**  
Tel: 86-756-3210040  
Fax: 86-756-3210049

### ASIA/PACIFIC

**India - Bangalore**  
Tel: 91-80-3090-4444  
Fax: 91-80-3090-4123

**India - New Delhi**  
Tel: 91-11-4160-8631  
Fax: 91-11-4160-8632

**India - Pune**  
Tel: 91-20-2566-1512  
Fax: 91-20-2566-1513

**Japan - Osaka**  
Tel: 81-6-6152-7160  
Fax: 81-6-6152-9310

**Japan - Tokyo**  
Tel: 81-3-6880-3770  
Fax: 81-3-6880-3771

**Korea - Daegu**  
Tel: 82-53-744-4301  
Fax: 82-53-744-4302

**Korea - Seoul**  
Tel: 82-2-554-7200  
Fax: 82-2-558-5932 or  
82-2-558-5934

**Malaysia - Kuala Lumpur**  
Tel: 60-3-6201-9857  
Fax: 60-3-6201-9859

**Malaysia - Penang**  
Tel: 60-4-227-8870  
Fax: 60-4-227-4068

**Philippines - Manila**  
Tel: 63-2-634-9065  
Fax: 63-2-634-9069

**Singapore**  
Tel: 65-6334-8870  
Fax: 65-6334-8850

**Taiwan - Hsin Chu**  
Tel: 886-3-5778-366  
Fax: 886-3-5770-955

**Taiwan - Kaohsiung**  
Tel: 886-7-213-7828  
Fax: 886-7-330-9305

**Taiwan - Taipei**  
Tel: 886-2-2508-8600  
Fax: 886-2-2508-0102

**Thailand - Bangkok**  
Tel: 66-2-694-1351  
Fax: 66-2-694-1350

### EUROPE

**Austria - Wels**  
Tel: 43-7242-2244-39  
Fax: 43-7242-2244-393

**Denmark - Copenhagen**  
Tel: 45-4450-2828  
Fax: 45-4485-2829

**France - Paris**  
Tel: 33-1-69-53-63-20  
Fax: 33-1-69-30-90-79

**Germany - Munich**  
Tel: 49-89-627-144-0  
Fax: 49-89-627-144-44

**Italy - Milan**  
Tel: 39-0331-742611  
Fax: 39-0331-466781

**Netherlands - Drunen**  
Tel: 31-416-690399  
Fax: 31-416-690340

**Spain - Madrid**  
Tel: 34-91-708-08-90  
Fax: 34-91-708-08-91

**UK - Wokingham**  
Tel: 44-118-921-5869  
Fax: 44-118-921-5820

11/29/12