

## Open-Drain Output Sub-Microamp Comparators

### Features

- Low Quiescent Current: 600 nA/Comparator (typical)
- Rail-to-Rail Input:  $V_{SS} - 0.3V$  to  $V_{DD} + 0.3V$
- Open-Drain Output:  $V_{OUT} \leq 10V$
- Propagation Delay: 4  $\mu s$  (typical, 100 mV Overdrive)
- Wide Supply Voltage Range: 1.6V to 5.5V
- Single Available in SOT-23-5, SC-70-5\* Packages
- Available in Single, Dual and Quad
- Chip Select ( $\overline{CS}$ ) with MCP6548
- Low Switching Current
- Internal Hysteresis: 3.3 mV (typical)
- Temperature Range:
  - Industrial:  $-40^{\circ}C$  to  $+85^{\circ}C$
  - Extended:  $-40^{\circ}C$  to  $+125^{\circ}C$

### Typical Applications

- Laptop Computers
- Mobile Phones
- Metering Systems
- Hand-held Electronics
- RC Timers
- Alarm and Monitoring Circuits
- Windowed Comparators
- Multi-vibrators

### Related Devices

- CMOS/TTL-Compatible Output: MCP6541/2/3/4

### Package Types



### Description

The Microchip Technology Inc. MCP6546/6R/6U/7/8/9 family of comparators, is offered in single (MCP6546, MCP6546R, MCP6546U), single with chip select ( $\overline{CS}$ ) (MCP6548), dual (MCP6547) and quad (MCP6549) configurations. The outputs are open-drain and are capable of driving heavy DC or capacitive loads.

These comparators are optimized for low power, single-supply application with greater than rail-to-rail input operation. The output limits supply current surges and dynamic power consumption while switching. The open-drain output of the MCP6546/6R/6U/7/8/9 family can be used as a level-shifter for up to 10V using a pull-up resistor. It can also be used as a wired-OR logic. The internal Input hysteresis eliminates output switching due to internal noise voltage, reducing current draw. These comparators operate with a single-supply voltage as low as 1.6V and draw a quiescent current of less than 1  $\mu A$ /comparator.

The related MCP6541/2/3/4 family of comparators from Microchip has a push-pull output that supports rail-to-rail output swing and interfaces with CMOS/TTL logic.

\* SC-70-5 E-Temp parts are not available at this release of the data sheet.

MCP6546U SOT-23-5 is E-Temp only.

# MCP6546/6R/6U/7/8/9

## 1.0 ELECTRICAL CHARACTERISTICS

### Absolute Maximum Ratings †

|  |                                    |
|--|------------------------------------|
| $V_{DD} - V_{SS}$ .....                        | 7.0V                               |
| Open-Drain Output .....                        | $V_{SS} + 10.5V$                   |
| Analog Input ( $V_{IN+}$ , $V_{IN-}$ )†† ..... | $V_{SS} - 1.0V$ to $V_{DD} + 1.0V$ |
| All Other Inputs and Outputs .....             | $V_{SS} - 0.3V$ to $V_{DD} + 0.3V$ |
| Difference Input Voltage .....                 | $ V_{DD} - V_{SS} $                |
| Output Short-Circuit Current .....             | continuous                         |
| Current at Input Pins .....                    | $\pm 2$ mA                         |
| Current at Output and Supply Pins .....        | $\pm 30$ mA                        |
| Storage Temperature .....                      | $-65^{\circ}C$ to $+150^{\circ}C$  |
| Maximum Junction Temperature ( $T_J$ ) .....   | $+150^{\circ}C$                    |
| ESD Protection on All Pins:                    |                                    |
| (HBM;MM) .....                                 | 2 kV;200V (MCP6546U)               |
| (HBM;MM) .....                                 | 4 kV; 200V (all other parts)       |

† **Notice:** Stresses above those listed under “Absolute Maximum Ratings” may cause permanent damage to the device. This is a stress rating only, and functional operation of the device, at those or any other conditions above those indicated in the operational listings of this specification, is not implied. Exposure to maximum rating conditions for extended periods may affect device reliability.

†† See [Section 4.1.2 “Input Voltage and Current Limits”](#)

### DC CHARACTERISTICS

**Electrical Specifications:** Unless otherwise indicated,  $V_{DD} = +1.6V$  to  $+5.5V$ ,  $V_{SS} = GND$ ,  $T_A = 25^{\circ}C$ ,  $V_{IN+} = V_{DD}/2$ ,  $V_{IN-} = V_{SS}$ ,  $R_{PU} = 2.74$  k $\Omega$  to  $V_{PU} = V_{DD}$  (Refer to [Figure 1-3](#)).

| Parameters                         | Sym                        | Min            | Typ       | Max            | Units               | Conditions  |
|------------------------------------|----------------------------|----------------|-----------|----------------|---------------------|---|
| <b>Power Supply</b>                |                            |                |           |                |                     |   |
| Supply Voltage                     | $V_{DD}$                   | 1.6            | —         | 5.5            | V                   | $V_{PU} \geq V_{DD}$  |
| Quiescent Current (per comparator) | $I_Q$                      | 0.3            | 0.6       | 1              | $\mu A$             | $I_{OUT} = 0$   |
| <b>Input</b>                       |                            |                |           |                |                     |   |
| Input Voltage Range                | $V_{CMR}$                  | $V_{SS} - 0.3$ | —         | $V_{DD} + 0.3$ | V                   |   |
| Common Mode Rejection Ratio        | CMRR                       | 55             | 70        | —              | dB                  | $V_{DD} = 5V$ , $V_{CM} = -0.3V$ to $5.3V$                                    |
| Common Mode Rejection Ratio        | CMRR                       | 50             | 65        | —              | dB                  | $V_{DD} = 5V$ , $V_{CM} = 2.5V$ to $5.3V$                                     |
| Common Mode Rejection Ratio        | CMRR                       | 55             | 70        | —              | dB                  | $V_{DD} = 5V$ , $V_{CM} = -0.3V$ to $2.5V$                                    |
| Power Supply Rejection Ratio       | PSRR                       | 63             | 80        | —              | dB                  | $V_{CM} = V_{SS}$   |
| Input Offset Voltage               | $V_{OS}$                   | -7.0           | $\pm 1.5$ | +7.0           | mV                  | $V_{CM} = V_{SS}$ ( <b>Note 1</b> )   |
| Drift with Temperature             | $\Delta V_{OS}/\Delta T_A$ | —              | $\pm 3$   | —              | $\mu V/^{\circ}C$   | $T_A = -40^{\circ}C$ to $+125^{\circ}C$ , $V_{CM} = V_{SS}$                   |
| Input Hysteresis Voltage           | $V_{HYST}$                 | 1.5            | 3.3       | 6.5            | mV                  | $V_{CM} = V_{SS}$ ( <b>Note 1</b> )   |
| Linear Temp. Co.                   | $TC_1$                     | —              | 6.7       | —              | $\mu V/^{\circ}C$   | $T_A = -40^{\circ}C$ to $+125^{\circ}C$ , $V_{CM} = V_{SS}$ ( <b>Note 2</b> ) |
| Quadratic Temp. Co.                | $TC_2$                     | —              | -0.035    | —              | $\mu V/^{\circ}C^2$ | $T_A = -40^{\circ}C$ to $+125^{\circ}C$ , $V_{CM} = V_{SS}$ ( <b>Note 2</b> ) |
| Input Bias Current                 | $I_B$                      | —              | 1         | —              | pA                  | $V_{CM} = V_{SS}$   |
| At Temperature (I-Temp parts)      | $I_B$                      | —              | 25        | 100            | pA                  | $T_A = +85^{\circ}C$ , $V_{CM} = V_{SS}$ ( <b>Note 3</b> )                    |
| At Temperature (E-Temp parts)      | $I_B$                      | —              | 1200      | 5000           | pA                  | $T_A = +125^{\circ}C$ , $V_{CM} = V_{SS}$ ( <b>Note 3</b> )                   |
| Input Offset Current               | $I_{OS}$                   | —              | $\pm 1$   | —              | pA                  | $V_{CM} = V_{SS}$   |

**Note 1:** The input offset voltage is the center of the input-referred trip points. The input hysteresis is the difference between the input-referred trip points.

**2:**  $V_{HYST}$  at differential temperatures is estimated using:

$$V_{HYST}(T_A) = V_{HYST} + (T_A - 25^{\circ}C) TC_1 + (T_A - 25^{\circ}C)^2 TC_2.$$

**3:** Input bias current at temperature is not tested for the SC-70-5 package.

**4:** Do not short the output above  $V_{SS} + 10V$ . Limit the output current to Absolute Maximum Rating of 30 mA. The minimum  $V_{PU}$  test limit was  $V_{DD}$  before Dec. 2004 (week code 52).

# MCP6546/6R/6U/7/8/9

## DC CHARACTERISTICS (CONTINUED)

**Electrical Specifications:** Unless otherwise indicated,  $V_{DD} = +1.6V$  to  $+5.5V$ ,  $V_{SS} = GND$ ,  $T_A = 25^\circ C$ ,  $V_{IN+} = V_{DD}/2$ ,  $V_{IN-} = V_{SS}$ ,  $R_{PU} = 2.74 k\Omega$  to  $V_{PU} = V_{DD}$  (Refer to [Figure 1-3](#)).

| Parameters                   | Sym        | Min      | Typ          | Max            | Units        | Conditions   |
|------------------------------|------------|----------|--------------|----------------|--------------|--|
| Common Mode Input Impedance  | $Z_{CM}$   | —        | $10^{13}  4$ | —              | $\Omega  pF$ |  |
| Differential Input Impedance | $Z_{DIFF}$ | —        | $10^{13}  2$ | —              | $\Omega  pF$ |  |
| <b>Open-Drain Output</b>     |            |          |              |                |              |  |
| Output Pull-Up Voltage       | $V_{PU}$   | 1.6      | —            | 10             | V            | ( <a href="#">Note 4</a> )   |
| High-Level Output Current    | $I_{OH}$   | -100     | —            | —              | nA           | $V_{DD} = 1.6V$ to $5.5V$ , $V_{PU} = 10V$<br>( <a href="#">Note 4</a> ) |
| Low-Level Output Voltage     | $V_{OL}$   | $V_{SS}$ | —            | $V_{SS} + 0.2$ | V            | $I_{OUT} = 2 mA$ , $V_{PU} = V_{DD} = 5V$                                |
| Short-Circuit Current        | $I_{SC}$   | —        | $\pm 1.5$    | —              | mA           | $V_{PU} = V_{DD} = 1.6V$ ( <a href="#">Note 4</a> )                      |
|                              | $I_{SC}$   | —        | 30           | —              | mA           | $V_{PU} = V_{DD} = 5.5V$ ( <a href="#">Note 4</a> )                      |
| Output Pin Capacitance       | $C_{OUT}$  | —        | 8            | —              | pF           |  |

**Note 1:** The input offset voltage is the center of the input-referred trip points. The input hysteresis is the difference between the input-referred trip points.

**2:**  $V_{HYST}$  at differential temperatures is estimated using:

$$V_{HYST}(T_A) = V_{HYST} + (T_A - 25^\circ C) TC_1 + (T_A - 25^\circ C)^2 TC_2.$$

**3:** Input bias current at temperature is not tested for the SC-70-5 package.

**4:** Do not short the output above  $V_{SS} + 10V$ . Limit the output current to Absolute Maximum Rating of 30 mA. The minimum  $V_{PU}$  test limit was  $V_{DD}$  before Dec. 2004 (week code 52).

## AC CHARACTERISTICS

**Electrical Specifications:** Unless otherwise indicated,  $V_{DD} = +1.6V$  to  $+5.5V$ ,  $V_{SS} = GND$ ,  $T_A = 25^\circ C$ ,  $V_{IN+} = V_{DD}/2$ , Step = 200 mV, Overdrive = 100 mV,  $R_{PU} = 2.74 k\Omega$  to  $V_{PU} = V_{DD}$ , and  $C_L = 36 pF$  (Refer to [Figure 1-2](#) and [Figure 1-3](#)).

| Parameters                      | Sym       | Min | Typ  | Max | Units         | Conditions                        |
|---------------------------------|-----------|-----|------|-----|---------------|-----------------------------------|
| Fall Time                       | $t_F$     | —   | 0.7  | —   | $\mu s$       | ( <a href="#">Note 1</a> )        |
| Propagation Delay (High-to-Low) | $t_{PHL}$ | —   | 4.0  | 8.0 | $\mu s$       |                                   |
| Propagation Delay (Low-to-High) | $t_{PLH}$ | —   | 3.0  | 8.0 | $\mu s$       | ( <a href="#">Note 1</a> )        |
| Propagation Delay Skew          | $t_{PDS}$ | —   | -1.0 | —   | $\mu s$       | ( <a href="#">Notes 1 and 2</a> ) |
| Maximum Toggle Frequency        | $f_{MAX}$ | —   | 225  | —   | kHz           | $V_{DD} = 1.6V$                   |
|                                 | $f_{MAX}$ | —   | 165  | —   | kHz           | $V_{DD} = 5.5V$                   |
| Input Noise Voltage             | $E_{ni}$  | —   | 200  | —   | $\mu V_{P-P}$ | 10 Hz to 100 kHz                  |

**Note 1:**  $t_R$  and  $t_{PLH}$  depend on the load ( $R_L$  and  $C_L$ ); these specifications are valid for the indicated load only.

**2:** Propagation Delay Skew is defined as:  $t_{PDS} = t_{PLH} - t_{PHL}$ .

# MCP6546/6R/6U/7/8/9

## MCP6548 CHIP SELECT ( $\overline{CS}$ ) CHARACTERISTICS

**Electrical Specifications:** Unless otherwise indicated,  $V_{DD} = +1.6V$  to  $+5.5V$ ,  $V_{SS} = GND$ ,  $T_A = 25^\circ C$ ,  $V_{IN+} = V_{DD}/2$ ,  $V_{IN-} = V_{SS}$ ,  $R_{PU} = 2.74\text{ k}\Omega$  to  $V_{PU} = V_{DD}$ , and  $C_L = 36\text{ pF}$  (Refer to [Figures 1-1](#) and [1-3](#)).

| Parameters   | Sym            | Min          | Typ | Max          | Units   | Conditions   |
|--|----------------|--------------|-----|--------------|---------|--|
| <b><math>\overline{CS}</math> Low Specifications</b>           |                |              |     |              |         |  |
| $\overline{CS}$ Logic Threshold, Low                           | $V_{IL}$       | $V_{SS}$     | —   | $0.2 V_{DD}$ | V       |  |
| $\overline{CS}$ Input Current, Low                             | $I_{CSL}$      | —            | 5   | —            | pA      | $\overline{CS} = V_{SS}$   |
| <b><math>\overline{CS}</math> High Specifications</b>          |                |              |     |              |         |  |
| $\overline{CS}$ Logic Threshold, High                          | $V_{IH}$       | $0.8 V_{DD}$ | —   | $V_{DD}$     | V       |  |
| $\overline{CS}$ Input Current, High                            | $I_{CSH}$      | —            | 1   | —            | pA      | $\overline{CS} = V_{DD}$   |
| $\overline{CS}$ Input High, $V_{DD}$ Current                   | $I_{DD}$       | —            | 18  | —            | pA      | $\overline{CS} = V_{DD}$   |
| $\overline{CS}$ Input High, GND Current                        | $I_{SS}$       | —            | -20 | —            | pA      | $\overline{CS} = V_{DD}$   |
| Comparator Output Leakage                                      | $I_{O(LEAK)}$  | —            | 1   | —            | pA      | $V_{OUT} = V_{SS}+10V$ , $\overline{CS} = V_{DD}$                        |
| <b><math>\overline{CS}</math> Dynamic Specifications</b>       |                |              |     |              |         |  |
| $\overline{CS}$ Low to Comparator Output Low Turn-on Time      | $t_{ON}$       | —            | 2   | 50           | ms      | $\overline{CS} = 0.2V_{DD}$ to $V_{OUT} = V_{DD}/2$ , $V_{IN-} = V_{DD}$ |
| $\overline{CS}$ High to Comparator Output High Z Turn-off Time | $t_{OFF}$      | —            | 10  | —            | $\mu s$ | $\overline{CS} = 0.8V_{DD}$ to $V_{OUT} = V_{DD}/2$ , $V_{IN-} = V_{DD}$ |
| $\overline{CS}$ Hysteresis                                     | $V_{CS\_HYST}$ | —            | 0.6 | —            | V       | $V_{DD} = 5V$  |



**FIGURE 1-1:** Timing Diagram for the  $\overline{CS}$  pin on the MCP6548.



**FIGURE 1-2:** Propagation Delay Timing Diagram.

## TEMPERATURE CHARACTERISTICS

| Electrical Specifications: Unless otherwise indicated, $V_{DD} = +1.6V$ to $+5.5V$ and $V_{SS} = GND$ . |               |     |       |      |       |            |
|---|---------------|-----|-------|------|-------|------------|
| Parameters  | Sym           | Min | Typ   | Max  | Units | Conditions |
| <b>Temperature Ranges</b>   |               |     |       |      |       |            |
| Specified Temperature Range   | $T_A$         | -40 | —     | +85  | °C    |            |
| Operating Temperature Range   | $T_A$         | -40 | —     | +125 | °C    | Note       |
| Storage Temperature Range   | $T_A$         | -65 | —     | +150 | °C    |            |
| <b>Thermal Package Resistances</b>  |               |     |       |      |       |            |
| Thermal Resistance, 5L-SC-70  | $\theta_{JA}$ | —   | 331   | —    | °C/W  |            |
| Thermal Resistance, 5L-SOT-23   | $\theta_{JA}$ | —   | 220.7 | —    | °C/W  |            |
| Thermal Resistance, 8L-MSOP   | $\theta_{JA}$ | —   | 211   | —    | °C/W  |            |
| Thermal Resistance, 8L-PDIP   | $\theta_{JA}$ | —   | 89.3  | —    | °C/W  |            |
| Thermal Resistance, 8L-SOIC   | $\theta_{JA}$ | —   | 149.5 | —    | °C/W  |            |
| Thermal Resistance, 14L-PDIP  | $\theta_{JA}$ | —   | 70    | —    | °C/W  |            |
| Thermal Resistance, 14L-SOIC  | $\theta_{JA}$ | —   | 95.3  | —    | °C/W  |            |
| Thermal Resistance, 14L-TSSOP   | $\theta_{JA}$ | —   | 100   | —    | °C/W  |            |

**Note:** The MCP6546/6R/6U/7/8/9 I-temp family operates over this extended temperature range, but with reduced performance. In any case, the Junction Temperature ( $T_J$ ) must not exceed the absolute maximum specification of  $+150^\circ\text{C}$ .

### 1.1 Test Circuit Configuration

This test circuit configuration is used to determine the AC and DC specifications.



**FIGURE 1-3:** AC and DC Test Circuit for the Open-Drain Output Comparators.

# MCP6546/6R/6U/7/8/9

## 2.0 TYPICAL PERFORMANCE CURVES

**Note:** The graphs and tables provided following this note are a statistical summary based on a limited number of samples and are provided for informational purposes only. The performance characteristics listed herein are not tested or guaranteed. In some graphs or tables, the data presented may be outside the specified operating range (e.g., outside specified power supply range) and therefore outside the warranted range.

**Note:** Unless otherwise indicated,  $V_{DD} = +1.6V$  to  $+5.5V$ ,  $V_{SS} = GND$ ,  $T_A = +25^\circ C$ ,  $V_{IN+} = V_{DD}/2$ ,  $V_{IN-} = GND$ ,  $R_{PU} = 2.74\text{ k}\Omega$  to  $V_{PU} = V_{DD}$ , and  $C_L = 36\text{ pF}$ .



**FIGURE 2-1:** Input Offset Voltage at  $V_{CM} = V_{SS}$ .



**FIGURE 2-4:** Input Hysteresis Voltage at  $V_{CM} = V_{SS}$ .



**FIGURE 2-2:** Input Offset Voltage Drift at  $V_{CM} = V_{SS}$ .



**FIGURE 2-5:** Input Hysteresis Voltage Linear Temp. Co. ( $TC_1$ ) at  $V_{CM} = V_{SS}$ .



**FIGURE 2-3:** The MCP6546/6R/6U/7/8/9 Comparators Show No Phase Reversal.



**FIGURE 2-6:** Input Hysteresis Voltage Quadratic Temp. Co. ( $TC_2$ ) at  $V_{CM} = V_{SS}$ .

# MCP6546/6R/6U/7/8/9

**Note:** Unless otherwise indicated,  $V_{DD} = +1.6V$  to  $+5.5V$ ,  $V_{SS} = GND$ ,  $T_A = +25^\circ C$ ,  $V_{IN+} = V_{DD}/2$ ,  $V_{IN-} = GND$ ,  $R_{PU} = 2.74\text{ k}\Omega$  to  $V_{PU} = V_{DD}$ , and  $C_L = 36\text{ pF}$ .



**FIGURE 2-7:** Input Offset Voltage vs. Ambient Temperature at  $V_{CM} = V_{SS}$ .



**FIGURE 2-10:** Input Hysteresis Voltage vs. Ambient Temperature at  $V_{CM} = V_{SS}$ .



**FIGURE 2-8:** Input Offset Voltage vs. Common Mode Input Voltage at  $V_{DD} = 1.6V$ .



**FIGURE 2-11:** Input Hysteresis Voltage vs. Common Mode Input Voltage at  $V_{DD} = 1.6V$ .



**FIGURE 2-9:** Input Offset Voltage vs. Common Mode Input Voltage at  $V_{DD} = 5.5V$ .



**FIGURE 2-12:** Input Hysteresis Voltage vs. Common Mode Input Voltage at  $V_{DD} = 5.5V$ .

# MCP6546/6R/6U/7/8/9

**Note:** Unless otherwise indicated,  $V_{DD} = +1.6V$  to  $+5.5V$ ,  $V_{SS} = GND$ ,  $T_A = +25^\circ C$ ,  $V_{IN+} = V_{DD}/2$ ,  $V_{IN-} = GND$ ,  $R_{PU} = 2.74\text{ k}\Omega$  to  $V_{PU} = V_{DD}$ , and  $C_L = 36\text{ pF}$ .



**FIGURE 2-13:** CMRR, PSRR vs. Ambient Temperature.



**FIGURE 2-16:** Input Bias Current, Input Offset Current vs. Common Mode Input Voltage.



**FIGURE 2-14:** Input Bias Current, Input Offset Current vs. Ambient Temperature.



**FIGURE 2-17:** Quiescent Current vs. Power Supply Voltage.



**FIGURE 2-15:** Quiescent Current vs. Common Mode Input Voltage at  $V_{DD} = 1.6V$ .



**FIGURE 2-18:** Quiescent Current vs. Common Mode Input Voltage at  $V_{DD} = 5.5V$ .



# MCP6546/6R/6U/7/8/9

**Note:** Unless otherwise indicated,  $V_{DD} = +1.6V$  to  $+5.5V$ ,  $V_{SS} = GND$ ,  $T_A = +25^\circ C$ ,  $V_{IN+} = V_{DD}/2$ ,  $V_{IN-} = GND$ ,  $R_{PU} = 2.74\text{ k}\Omega$  to  $V_{PU} = V_{DD}$ , and  $C_L = 36\text{ pF}$ .



**FIGURE 2-19:** Supply Current vs. Pull-Up Voltage.

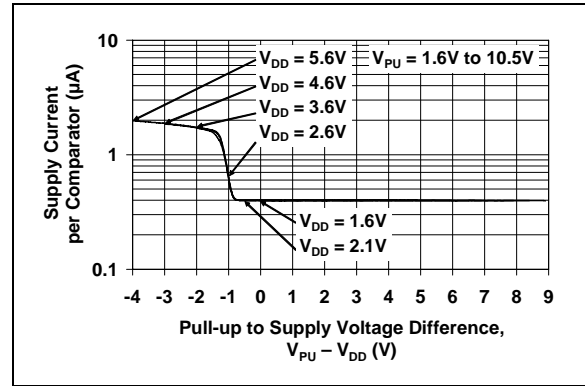

**FIGURE 2-22:** Supply Current vs. Pull-Up to Supply Voltage Difference.



**FIGURE 2-20:** Supply Current vs. Toggle Frequency.

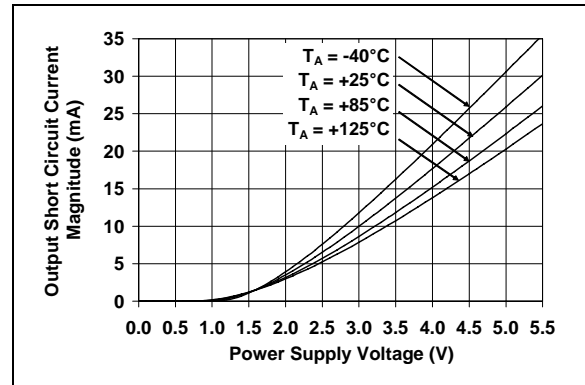

**FIGURE 2-23:** Output Short Circuit Current Magnitude vs. Power Supply Voltage.



**FIGURE 2-21:** Output Voltage Headroom vs. Output Current at  $V_{DD} = 1.6V$ .

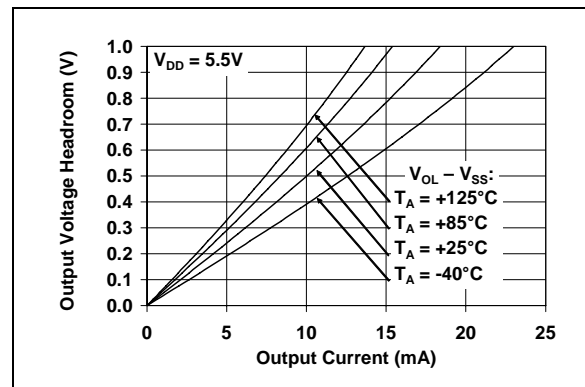

**FIGURE 2-24:** Output Voltage Headroom vs. Output Current at  $V_{DD} = 5.5V$ .

# MCP6546/6R/6U/7/8/9

**Note:** Unless otherwise indicated,  $V_{DD} = +1.6V$  to  $+5.5V$ ,  $V_{SS} = GND$ ,  $T_A = +25^\circ C$ ,  $V_{IN+} = V_{DD}/2$ ,  $V_{IN-} = GND$ ,  $R_{PU} = 2.74\text{ k}\Omega$  to  $V_{PU} = V_{DD}$ , and  $C_L = 36\text{ pF}$ .



**FIGURE 2-25:** High-to-Low Propagation Delay.



**FIGURE 2-28:** Low-to-High Propagation Delay.



**FIGURE 2-26:** Propagation Delay Skew.



**FIGURE 2-29:** Propagation Delay vs. Ambient Temperature.



**FIGURE 2-27:** Propagation Delay vs. Power Supply Voltage.



**FIGURE 2-30:** Propagation Delay vs. Input Overdrive.

# MCP6546/6R/6U/7/8/9

**Note:** Unless otherwise indicated,  $V_{DD} = +1.6V$  to  $+5.5V$ ,  $V_{SS} = GND$ ,  $T_A = +25^\circ C$ ,  $V_{IN+} = V_{DD}/2$ ,  $V_{IN-} = GND$ ,  $R_{PU} = 2.74 k\Omega$  to  $V_{PU} = V_{DD}$ , and  $C_L = 36 pF$ .



**FIGURE 2-31:** Propagation Delay vs. Common Mode Input Voltage at  $V_{DD} = 1.6V$ .



**FIGURE 2-34:** Propagation Delay vs. Common Mode Input Voltage at  $V_{DD} = 5.5V$ .



**FIGURE 2-32:** Propagation Delay vs. Pull-up Resistor.



**FIGURE 2-35:** Propagation Delay vs. Load Capacitance.



**FIGURE 2-33:** Propagation Delay vs. Pull-up Voltage.



**FIGURE 2-36:** Output Leakage Current ( $C_S = V_{DD}$ ) vs. Output Voltage (MCP6548 only).

# MCP6546/6R/6U/7/8/9

**Note:** Unless otherwise indicated,  $V_{DD} = +1.6V$  to  $+5.5V$ ,  $V_{SS} = GND$ ,  $T_A = +25^\circ C$ ,  $V_{IN+} = V_{DD}/2$ ,  $V_{IN-} = GND$ ,  $R_{PU} = 2.74\text{ k}\Omega$  to  $V_{PU} = V_{DD}$ , and  $C_L = 36\text{ pF}$ .



**FIGURE 2-37:** Supply Current (Shoot-through Current) vs. Chip Select (CS) Voltage at  $V_{DD} = 1.6V$  (MCP6548 only).



**FIGURE 2-40:** Supply Current (Shoot-through Current) vs. Chip Select (CS) Voltage at  $V_{DD} = 5.5V$  (MCP6548 only).



**FIGURE 2-38:** Supply Current (Charging Current) vs. Chip Select (CS) pulse at  $V_{DD} = 1.6V$  (MCP6548 only).



**FIGURE 2-41:** Supply Current (Charging Current) vs. Chip Select (CS) pulse at  $V_{DD} = 5.5V$  (MCP6548 only).



**FIGURE 2-39:** Chip Select (CS) Step Response (MCP6548 only).



**FIGURE 2-42:** Input Bias Current vs. Input Voltage.

## 3.0 PIN DESCRIPTIONS

Descriptions of the pins are listed in [Table 3-1](#).

**TABLE 3-1: PIN FUNCTION TABLE**

| MCP6546          | MCP6546       | MCP6546R | MCP6546U        | MCP6547          | MCP6548          | MCP6549           | Symbol                 | Description                        |
|------------------|---------------|----------|-----------------|------------------|------------------|-------------------|------------------------|------------------------------------|
| PDIP, SOIC, MSOP | SC-70, SOT-23 | SOT-23-5 | SC-70, SOT-23-5 | PDIP, SOIC, MSOP | PDIP, SOIC, MSOP | PDIP, SOIC, TSSOP |                        |                                    |
| 6                | 1             | 1        | 4               | 1                | 6                | 1                 | OUT, OUTA              | Digital Output (comparator A)      |
| 2                | 4             | 4        | 3               | 2                | 2                | 2                 | $V_{IN-}$ , $V_{INA-}$ | Inverting Input (comparator A)     |
| 3                | 3             | 3        | 1               | 3                | 3                | 3                 | $V_{IN+}$ , $V_{INA+}$ | Non-inverting Input (comparator A) |
| 7                | 5             | 2        | 5               | 8                | 7                | 4                 | $V_{DD}$               | Positive Power Supply              |
| —                | —             | —        | —               | 5                | —                | 5                 | $V_{INB+}$             | Non-inverting Input (comparator B) |
| —                | —             | —        | —               | 6                | —                | 6                 | $V_{INB-}$             | Inverting Input (comparator B)     |
| —                | —             | —        | —               | 7                | —                | 7                 | OUTB                   | Digital Output (comparator B)      |
| —                | —             | —        | —               | —                | —                | 8                 | OUTC                   | Digital Output (comparator C)      |
| —                | —             | —        | —               | —                | —                | 9                 | $V_{INC-}$             | Inverting Input (comparator C)     |
| —                | —             | —        | —               | —                | —                | 10                | $V_{INC+}$             | Non-inverting Input (comparator C) |
| 4                | 2             | 5        | 2               | 4                | 4                | 11                | $V_{SS}$               | Negative Power Supply              |
| —                | —             | —        | —               | —                | —                | 12                | $V_{IND+}$             | Non-inverting Input (comparator D) |
| —                | —             | —        | —               | —                | —                | 13                | $V_{IND-}$             | Inverting Input (comparator D)     |
| —                | —             | —        | —               | —                | —                | 14                | OUTD                   | Digital Output (comparator D)      |
| —                | —             | —        | —               | —                | 8                | —                 | $\overline{CS}$        | Chip Select                        |
| 1, 5, 8          | —             | —        | —               | —                | 1, 5             | —                 | NC                     | No Internal Connection             |

### 3.1 Analog Inputs

The comparator non-inverting and inverting inputs are high-impedance CMOS inputs with low bias currents.

### 3.2 $\overline{CS}$ Digital Input

This is a CMOS, Schmitt-triggered input that places the part into a low power mode of operation.

### 3.3 Digital Outputs

The comparator outputs are CMOS, open-drain digital outputs. They are designed to make level shifting and wired-OR easy to implement.

### 3.4 Power Supply ( $V_{SS}$ and $V_{DD}$ )

The positive power supply pin ( $V_{DD}$ ) is 1.6V to 5.5V higher than the negative power supply pin ( $V_{SS}$ ). For normal operation, the other pins are at voltages between  $V_{SS}$  and  $V_{DD}$ , except the output pins which can be as high as 10V above  $V_{SS}$ .

Typically, these parts are used in a single (positive) supply configuration. In this case,  $V_{SS}$  is connected to ground and  $V_{DD}$  is connected to the supply.  $V_{DD}$  will need a local bypass capacitor (typically 0.01  $\mu$ F to 0.1  $\mu$ F) within 2 mm of the  $V_{DD}$  pin. These can share a bulk capacitor with nearby analog parts (within 100 mm), but it is not required.

# MCP6546/6R/6U/7/8/9

---

NOTES:

## 4.0 APPLICATIONS INFORMATION

The MCP6546/6R/6U/7/8/9 family of push-pull output comparators are fabricated on Microchip's state-of-the-art CMOS process. They are suitable for a wide range of applications requiring very low power consumption.

### 4.1 Comparator Inputs

#### 4.1.1 PHASE REVERSAL

The MCP6546/6R/6U/7/8/9 comparator family uses CMOS transistors at the input. They are designed to prevent phase inversion when the input pins exceed the supply voltages. Figure 2-3 shows an input voltage exceeding both supplies with no resulting phase inversion.

#### 4.1.2 INPUT VOLTAGE AND CURRENT LIMITS

The ESD protection on the inputs can be depicted as shown in Figure 4-1. This structure was chosen to protect the input transistors, and to minimize input bias current (IB). The input ESD diodes clamp the inputs when they try to go more than one diode drop below  $V_{SS}$ . They also clamp any voltages that go too far above  $V_{DD}$ ; their breakdown voltage is high enough to allow normal operation, and low enough to bypass ESD events within the specified limits.



**FIGURE 4-1:** Simplified Analog Input ESD Structures.

In order to prevent damage and/or improper operation of these amplifiers, the circuits they are in must limit the currents (and voltages) at the  $V_{IN+}$  and  $V_{IN-}$  pins (see [Absolute Maximum Ratings](#) † at the beginning of [Section 1.0 “Electrical Characteristics”](#)). Figure 4-3 shows the recommended approach to protecting these inputs. The internal ESD diodes prevent the input pins ( $V_{IN+}$  and  $V_{IN-}$ ) from going too far below ground, and the resistors  $R_1$  and  $R_2$  limit the possible current drawn out of the input pin. Diodes  $D_1$  and  $D_2$  prevent the input pin ( $V_{IN+}$  and  $V_{IN-}$ ) from going too far above  $V_{DD}$ . When implemented as shown, resistors  $R_1$  and  $R_2$  also limit the current through  $D_1$  and  $D_2$ .



**FIGURE 4-2:** Protecting the Analog Inputs.

It is also possible to connect the diodes to the left of resistors  $R_1$  and  $R_2$ . In this case, the currents through diodes  $D_1$  and  $D_2$  need to be limited by some other mechanism. The resistor then serves as in-rush current limiter; the DC current into the input pins ( $V_{IN+}$  and  $V_{IN-}$ ) should be very small.

A significant amount of current can flow out of the inputs when the common mode voltage ( $V_{CM}$ ) is below ground ( $V_{SS}$ ); see [Figure 2-42](#). Applications that are high impedance may need to limit the usable voltage range.

#### 4.1.3 NORMAL OPERATION

The input stage of this family of devices uses two differential input stages in parallel, one operates at low input voltages, and the other at high input voltages. With this topology, the input voltage is 0.3V above  $V_{DD}$  and 0.3V below  $V_{SS}$ . The input offset voltage is measured at both  $V_{SS} - 0.3V$  and  $V_{DD} + 0.3V$  to ensure proper operation.

The MCP6546/6R/6U/7/8/9 family has internally-set hysteresis that is small enough to maintain input offset accuracy (<7 mV), and large enough to eliminate output chattering caused by the comparator's own input noise voltage (200  $\mu V_{P-P}$ ). [Figure 4-3](#) illustrates this capability.

# MCP6546/6R/6U/7/8/9



**FIGURE 4-3:** The MCP6546/6R/6U/7/8/9 Comparators' Internal Hysteresis Eliminates Output Chatter Caused By Input Noise Voltage.

## 4.2 Open-Drain Output

The open-drain output is designed to make level-shifting and wired-OR logic easy to implement. The output can go as high as 10V for 9V battery-powered applications. The output stage minimizes switching current (shoot-through current from supply-to-supply) when the output changes state. See Figures 2-15, 2-18 and 2-37 through 2-41, for more information.

## 4.3 MCP6548 Chip Select ( $\overline{CS}$ )

The MCP6548 is a single comparator with a Chip Select ( $\overline{CS}$ ) pin. When  $\overline{CS}$  is pulled high, the total current consumption drops to 20 pA (typical). 1 pA (typical) flows through the  $\overline{CS}$  pin, 1 pA (typical) flows through the output pin and 18 pA (typical) flows through the  $V_{DD}$  pin, as shown in Figure 1-1. When this happens, the comparator output is put into a high-impedance state. By pulling  $\overline{CS}$  low, the comparator is enabled. If the  $\overline{CS}$  pin is left floating, the comparator will not operate properly. Figure 1-1 shows the output voltage and supply current response to a  $\overline{CS}$  pulse.

The internal  $\overline{CS}$  circuitry is designed to minimize glitches when cycling the  $\overline{CS}$  pin. This helps conserve power, which is especially important in battery-powered applications.

## 4.4 Externally Set Hysteresis

Greater flexibility in selecting hysteresis, or input trip points, is achieved by using external resistors.

Input offset voltage ( $V_{OS}$ ) is the center (average) of the (input-referred) low-high and high-low trip points. Input hysteresis voltage ( $V_{HYST}$ ) is the difference between the same trip points. Hysteresis reduces output chattering when one input is slowly moving past the other, thus reducing dynamic supply current. It also helps in systems where it is best not to cycle between states too frequently (e.g., air conditioner thermostatic control).

### 4.4.1 INVERTING CIRCUIT

Figure 4-4 shows an inverting circuit for a single-supply application using three resistors, besides the pull-up resistor. The resulting hysteresis diagram is shown in Figure 4-5.



**FIGURE 4-4:** Inverting Circuit with Hysteresis.



**FIGURE 4-5:** Hysteresis Diagram for the Inverting Circuit.

In order to determine the trip voltages ( $V_{THL}$  and  $V_{TLH}$ ) for the circuit shown in Figure 4-4,  $R_2$  and  $R_3$  can be simplified to the Thevenin equivalent circuit with respect to  $V_{DD}$ , as shown in Figure 4-6.



**FIGURE 4-6:** Thevenin Equivalent Circuit.



## EQUATION 4-1:

$$R_{23} = \frac{R_2 R_3}{R_2 + R_3}$$

$$V_{23} = \frac{R_3}{R_2 + R_3} \times V_{DD}$$

Using this simplified circuit, the trip voltage can be calculated using the following equation:

## EQUATION 4-2:

$$V_{THL} = V_{PU} \left( \frac{R_{23}}{R_{23} + R_F + R_{PU}} \right) + V_{23} \left( \frac{R_F + R_{PU}}{R_{23} + R_F + R_{PU}} \right)$$

$$V_{TLH} = V_{OL} \left( \frac{R_{23}}{R_{23} + R_F} \right) + V_{23} \left( \frac{R_F}{R_{23} + R_F} \right)$$

$V_{TLH}$  = trip voltage from low to high  
 $V_{THL}$  = trip voltage from high to low

Figures 2-21 and 2-24 can be used to determine typical values for  $V_{OL}$ . This voltage is dependent on the output current  $I_{OL}$  as shown in Figure 4-4. This current can be determined using the equation below:

## EQUATION 4-3:

$$I_{OL} = I_{PU} + I_{RF}$$

$$I_{OL} = \left( \frac{V_{PU} - V_{OL}}{R_{PU}} \right) + \left( \frac{V_{23} - V_{OL}}{R_{23} + R_F} \right)$$

$V_{OH}$  can be calculated using the equation below:

## EQUATION 4-4:

$$V_{OH} = (V_{PU} - V_{23}) \times \left( \frac{R_{23} + R_F}{R_{23} + R_F + R_{PU}} \right)$$

As explained in Section 4.1 “Comparator Inputs”, it is important to keep the non-inverting input below  $V_{DD} + 0.3V$  when  $V_{PU} > V_{DD}$ .

## 4.5 Supply Bypass

With this family of comparators, the power supply pin ( $V_{DD}$  for single supply) should have a local bypass capacitor (i.e., 0.01  $\mu F$  to 0.1  $\mu F$ ) within 2 mm for good edge-rate performance.

## 4.6 Capacitive Loads

Reasonable capacitive loads (e.g., logic gates) have little impact on propagation delay (see Figure 2-27). The supply current increases with increasing toggle frequency (Figure 2-30), especially with higher capacitive loads.

## 4.7 Battery Life

In order to maximize battery life in portable applications, use large resistors and small capacitive loads. Avoid toggling the output more than necessary. Do not use Chip Select ( $\overline{CS}$ ) too frequently, in order to conserve power. Capacitive loads will draw additional power at start-up.

## 4.8 PCB Surface Leakage

In applications where low input bias current is critical, PCB (Printed Circuit Board) surface leakage effects need to be considered. Surface leakage is caused by humidity, dust or other contamination on the board. Under low-humidity conditions, a typical resistance between nearby traces is  $10^{12}\Omega$ . A 5V difference would cause 5 pA of current to flow. This is greater than the MCP6546/6R/6U/7/8/9 family’s bias current at 25°C (1 pA, typical).

The easiest way to reduce surface leakage is to use a guard ring around sensitive pins (or traces). The guard ring is biased at the same voltage as the sensitive pin. An example of this type of layout is shown in Figure 4-7.



**FIGURE 4-7:** Example Guard Ring Layout for Inverting Circuit.

1. For the Inverting Configuration (Figures 4-4 and 4-7):
  - a) Connect the guard ring to the non-inverting input pin ( $V_{IN+}$ ). This biases the guard ring to the same reference voltage as the comparator (e.g.,  $V_{DD}/2$  or ground).
  - b) Connect the inverting pin ( $V_{IN-}$ ) to the input pad, without touching the guard ring.

# MCP6546/6R/6U/7/8/9

## 4.9 Unused Comparators

An unused amplifier in a quad package (MCP6549) should be configured as shown in Figure 4-8. This circuit prevents the output from toggling and causing crosstalk. It uses the minimum number of components and draws minimal current (see Figure 2-15 and Figure 2-18).



FIGURE 4-8: Unused Comparators.

## 4.10 Typical Applications

### 4.10.1 PRECISE COMPARATOR

Some applications require higher DC precision. An easy way to solve this problem is to use an amplifier (such as the MCP6041) to gain-up the input signal before it reaches the comparator. Figure 4-9 shows an example of this approach.



FIGURE 4-9: Precise Inverting Comparator.

### 4.10.2 WINDOWED COMPARATOR

Figure 4-10 shows one approach to designing a windowed comparator. The wired-OR connection produces a high output (logic 1) when the input voltage is between  $V_{RB}$  and  $V_{RT}$  (where  $V_{RT} > V_{RB}$ ).

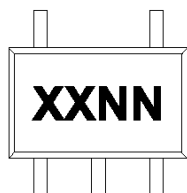

FIGURE 4-10: Windowed Comparator.

## 5.0 PACKAGING INFORMATION

### 5.1 Package Marking Information

#### 5-Lead SC-70 (MCP6546, MCP6546U)



| Device   | I-Temp Code | E-Temp Code |
|----------|-------------|-------------|
| MCP6546  | ACNN        | Note 2      |
| MCP6546U | BBNN        | Note 2      |

- Note 1:** I-Temp parts prior to March 2005 are marked "ACN"  
**Note 2:** SC-70-5 E-Temp parts not available at this release of the data sheet.

Example: (I-temp)



Example: (I-temp)



OR

#### 5-Lead SOT-23 (MCP6546, MCP6546R, MCP6546U)



| Device   | I-Temp Code | E-Temp Code |
|----------|-------------|-------------|
| MCP6546  | ACNN        | GWNN        |
| MCP6546R | AHNN        | GXNN        |
| MCP6546U | —           | AWNN        |

**Note:** Applies to 5-Lead SOT-23

Example: (I-temp)



#### 8-Lead PDIP (300 mil) (MCP6546, MCP6547, MCP6548, MCP6549)

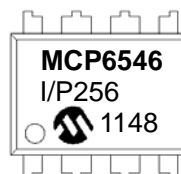

OR



Examples:

#### 8-Lead SOIC (150 mil) (MCP6546, MCP6547, MCP6548, MCP6549)



OR



| Legend: |  |
|---------|--|
| XX...X  | Customer-specific information                              |
| Y       | Year code (last digit of calendar year)                    |
| YY      | Year code (last 2 digits of calendar year)                 |
| WW      | Week code (week of January 1 is week '01')                 |
| NNN     | Alphanumeric traceability code                             |
| (e3)    | Pb-free JEDEC designator for Matte Tin (Sn)                |
| *       | This package is Pb-free. The Pb-free JEDEC designator (e3) |

**Note:** In the event the full Microchip part number cannot be marked on one line, it will be carried over to the next line, thus limiting the number of available characters for customer-specific information.

# MCP6546/6R/6U/7/8/9

## Package Marking Information (Continued)

8-Lead MSOP (MCP6546, MCP6547, MCP6548)



Example:



14-Lead PDIP (300 mil) (MCP6549)



Example:



OR



OR



|                |   |  |
|----------------|---|--|
| <b>Legend:</b> | XX...X  | Customer-specific information                              |
|                | Y   | Year code (last digit of calendar year)                    |
|                | YY  | Year code (last 2 digits of calendar year)                 |
|                | WW  | Week code (week of January 1 is week '01')                 |
|                | NNN   | Alphanumeric traceability code                             |
|                | (e3)  | Pb-free JEDEC designator for Matte Tin (Sn)                |
|                | *   | This package is Pb-free. The Pb-free JEDEC designator (e3) |
| <b>Note:</b>   | In the event the full Microchip part number cannot be marked on one line, it will be carried over to the next line, thus limiting the number of available characters for customer-specific information. |  |

# MCP6546/6R/6U/7/8/9

## Package Marking Information (Continued)

14-Lead SOIC (150 mil) (MCP6549)

Example:



OR



14-Lead TSSOP (MCP6549)

Example:



|                |   |  |
|----------------|---|--|
| <b>Legend:</b> | XX...X  | Customer-specific information                              |
|                | Y   | Year code (last digit of calendar year)                    |
|                | YY  | Year code (last 2 digits of calendar year)                 |
|                | WW  | Week code (week of January 1 is week '01')                 |
|                | NNN   | Alphanumeric traceability code                             |
|                | (e3)  | Pb-free JEDEC designator for Matte Tin (Sn)                |
|                | *   | This package is Pb-free. The Pb-free JEDEC designator (e3) |
| <b>Note:</b>   | In the event the full Microchip part number cannot be marked on one line, it will be carried over to the next line, thus limiting the number of available characters for customer-specific information. |  |

# MCP6546/6R/6U/7/8/9

## 5-Lead Plastic Small Outline Transistor (LT) [SC70]

**Note:** For the most current package drawings, please see the Microchip Packaging Specification located at <http://www.microchip.com/packaging>



|                          |    | Units | MILLIMETERS |      |     |
|--------------------------|----|-------|-------------|------|-----|
| Dimension Limits         |    |       | MIN         | NOM  | MAX |
| Number of Pins           | N  |       | 5           |      |     |
| Pitch                    | e  |       | 0.65 BSC    |      |     |
| Overall Height           | A  | 0.80  | –           | 1.10 |     |
| Molded Package Thickness | A2 | 0.80  | –           | 1.00 |     |
| Standoff                 | A1 | 0.00  | –           | 0.10 |     |
| Overall Width            | E  | 1.80  | 2.10        | 2.40 |     |
| Molded Package Width     | E1 | 1.15  | 1.25        | 1.35 |     |
| Overall Length           | D  | 1.80  | 2.00        | 2.25 |     |
| Foot Length              | L  | 0.10  | 0.20        | 0.46 |     |
| Lead Thickness           | c  | 0.08  | –           | 0.26 |     |
| Lead Width               | b  | 0.15  | –           | 0.40 |     |

**Notes:**

- Dimensions D and E1 do not include mold flash or protrusions. Mold flash or protrusions shall not exceed 0.127 mm per side.
- Dimensioning and tolerancing per ASME Y14.5M.  
BSC: Basic Dimension. Theoretically exact value shown without tolerances.

Microchip Technology Drawing C04-061B

## 5-Lead Plastic Small Outline Transistor (LT) [SC70]

**Note:** For the most current package drawings, please see the Microchip Packaging Specification located at <http://www.microchip.com/packaging>



RECOMMENDED LAND PATTERN

| Dimension Limits      | Units | MILLIMETERS |     |      |
|-----------------------|-------|-------------|-----|------|
|                       |       | MIN         | NOM | MAX  |
| Contact Pitch         | E     | 0.65 BSC    |     |      |
| Contact Pad Spacing   | C     | 2.20        |     |      |
| Contact Pad Width     | X     |             |     | 0.45 |
| Contact Pad Length    | Y     |             |     | 0.95 |
| Distance Between Pads | G     | 1.25        |     |      |
| Distance Between Pads | Gx    | 0.20        |     |      |

**Notes:**

1. Dimensioning and tolerancing per ASME Y14.5M

BSC: Basic Dimension. Theoretically exact value shown without tolerances.

Microchip Technology Drawing No. C04-2061A

# MCP6546/6R/6U/7/8/9

## 5-Lead Plastic Small Outline Transistor (OT) [SOT-23]

**Note:** For the most current package drawings, please see the Microchip Packaging Specification located at <http://www.microchip.com/packaging>



| Dimension Limits         | Units  | MILLIMETERS |     |      |
|--------------------------|--------|-------------|-----|------|
|                          |        | MIN         | NOM | MAX  |
| Number of Pins           | N      | 5           |     |      |
| Lead Pitch               | e      | 0.95 BSC    |     |      |
| Outside Lead Pitch       | e1     | 1.90 BSC    |     |      |
| Overall Height           | A      | 0.90        | –   | 1.45 |
| Molded Package Thickness | A2     | 0.89        | –   | 1.30 |
| Standoff                 | A1     | 0.00        | –   | 0.15 |
| Overall Width            | E      | 2.20        | –   | 3.20 |
| Molded Package Width     | E1     | 1.30        | –   | 1.80 |
| Overall Length           | D      | 2.70        | –   | 3.10 |
| Foot Length              | L      | 0.10        | –   | 0.60 |
| Footprint                | L1     | 0.35        | –   | 0.80 |
| Foot Angle               | $\phi$ | 0°          | –   | 30°  |
| Lead Thickness           | c      | 0.08        | –   | 0.26 |
| Lead Width               | b      | 0.20        | –   | 0.51 |

**Notes:**

- Dimensions D and E1 do not include mold flash or protrusions. Mold flash or protrusions shall not exceed 0.127 mm per side.
- Dimensioning and tolerancing per ASME Y14.5M.

BSC: Basic Dimension. Theoretically exact value shown without tolerances.

Microchip Technology Drawing C04-091B



## 5-Lead Plastic Small Outline Transistor (OT) [SOT-23]

**Note:** For the most current package drawings, please see the Microchip Packaging Specification located at <http://www.microchip.com/packaging>



| Dimension Limits        | Units | MILLIMETERS |      |      |
|-------------------------|-------|-------------|------|------|
|                         |       | MIN         | NOM  | MAX  |
| Contact Pitch           | E     | 0.95 BSC    |      |      |
| Contact Pad Spacing     | C     |             | 2.80 |      |
| Contact Pad Width (X5)  | X     |             |      | 0.60 |
| Contact Pad Length (X5) | Y     |             |      | 1.10 |
| Distance Between Pads   | G     | 1.70        |      |      |
| Distance Between Pads   | GX    | 0.35        |      |      |
| Overall Width           | Z     |             |      | 3.90 |

**Notes:**

1. Dimensioning and tolerancing per ASME Y14.5M

BSC: Basic Dimension. Theoretically exact value shown without tolerances.

Microchip Technology Drawing No. C04-2091A

# MCP6546/6R/6U/7/8/9

## 8-Lead Plastic Dual In-Line (P) – 300 mil Body [PDIP]

**Note:** For the most current package drawings, please see the Microchip Packaging Specification located at <http://www.microchip.com/packageing>



| Dimension Limits           | Units | INCHES   |      |      |
|----------------------------|-------|----------|------|------|
|                            |       | MIN      | NOM  | MAX  |
| Number of Pins             | N     | 8        |      |      |
| Pitch                      | e     | .100 BSC |      |      |
| Top to Seating Plane       | A     | –        | –    | .210 |
| Molded Package Thickness   | A2    | .115     | .130 | .195 |
| Base to Seating Plane      | A1    | .015     | –    | –    |
| Shoulder to Shoulder Width | E     | .290     | .310 | .325 |
| Molded Package Width       | E1    | .240     | .250 | .280 |
| Overall Length             | D     | .348     | .365 | .400 |
| Tip to Seating Plane       | L     | .115     | .130 | .150 |
| Lead Thickness             | c     | .008     | .010 | .015 |
| Upper Lead Width           | b1    | .040     | .060 | .070 |
| Lower Lead Width           | b     | .014     | .018 | .022 |
| Overall Row Spacing §      | eB    | –        | –    | .430 |

**Notes:**

- Pin 1 visual index feature may vary, but must be located with the hatched area.
- § Significant Characteristic.
- Dimensions D and E1 do not include mold flash or protrusions. Mold flash or protrusions shall not exceed .010" per side.
- Dimensioning and tolerancing per ASME Y14.5M.

BSC: Basic Dimension. Theoretically exact value shown without tolerances.

Microchip Technology Drawing C04-018B

# MCP6546/6R/6U/7/8/9

## 8-Lead Plastic Small Outline (SN) - Narrow, 3.90 mm Body [SOIC]

**Note:** For the most current package drawings, please see the Microchip Packaging Specification located at <http://www.microchip.com/packaging>



Microchip Technology Drawing No. C04-057C Sheet 1 of 2

# MCP6546/6R/6U/7/8/9

## 8-Lead Plastic Small Outline (SN) - Narrow, 3.90 mm Body [SOIC]

**Note:** For the most current package drawings, please see the Microchip Packaging Specification located at <http://www.microchip.com/packaging>



| Dimension Limits         | Units | MILLIMETERS |     |      |
|--------------------------|-------|-------------|-----|------|
|                          |       | MIN         | NOM | MAX  |
| Number of Pins           | N     | 8           |     |      |
| Pitch                    | e     | 1.27 BSC    |     |      |
| Overall Height           | A     | -           | -   | 1.75 |
| Molded Package Thickness | A2    | 1.25        | -   | -    |
| Standoff §               | A1    | 0.10        | -   | 0.25 |
| Overall Width            | E     | 6.00 BSC    |     |      |
| Molded Package Width     | E1    | 3.90 BSC    |     |      |
| Overall Length           | D     | 4.90 BSC    |     |      |
| Chamfer (Optional)       | h     | 0.25        | -   | 0.50 |
| Foot Length              | L     | 0.40        | -   | 1.27 |
| Footprint                | L1    | 1.04 REF    |     |      |
| Foot Angle               | φ     | 0°          | -   | 8°   |
| Lead Thickness           | c     | 0.17        | -   | 0.25 |
| Lead Width               | b     | 0.31        | -   | 0.51 |
| Mold Draft Angle Top     | α     | 5°          | -   | 15°  |
| Mold Draft Angle Bottom  | β     | 5°          | -   | 15°  |

### Notes:

1. Pin 1 visual index feature may vary, but must be located within the hatched area.
2. § Significant Characteristic
3. Dimensions D and E1 do not include mold flash or protrusions. Mold flash or protrusions shall not exceed 0.15mm per side.
4. Dimensioning and tolerancing per ASME Y14.5M

BSC: Basic Dimension. Theoretically exact value shown without tolerances.

REF: Reference Dimension, usually without tolerance, for information purposes only.

Microchip Technology Drawing No. C04-057C Sheet 2 of 2

# MCP6546/6R/6U/7/8/9

## 8-Lead Plastic Small Outline (SN) – Narrow, 3.90 mm Body [SOIC]

**Note:** For the most current package drawings, please see the Microchip Packaging Specification located at <http://www.microchip.com/packaging>



RECOMMENDED LAND PATTERN

| Dimension Limits        | Units | MILLIMETERS |      |      |
|-------------------------|-------|-------------|------|------|
|                         |       | MIN         | NOM  | MAX  |
| Contact Pitch           | E     | 1.27 BSC    |      |      |
| Contact Pad Spacing     | C     |             | 5.40 |      |
| Contact Pad Width (X8)  | X1    |             |      | 0.60 |
| Contact Pad Length (X8) | Y1    |             |      | 1.55 |

Notes:

1. Dimensioning and tolerancing per ASME Y14.5M

BSC: Basic Dimension. Theoretically exact value shown without tolerances.

Microchip Technology Drawing No. C04-2057A

# MCP6546/6R/6U/7/8/9

## 8-Lead Plastic Micro Small Outline Package (MS) [MSOP]

**Note:** For the most current package drawings, please see the Microchip Packaging Specification located at <http://www.microchip.com/packaging>



Microchip Technology Drawing C04-111C Sheet 1 of 2

# MCP6546/6R/6U/7/8/9

## 8-Lead Plastic Micro Small Outline Package (MS) [MSOP]

**Note:** For the most current package drawings, please see the Microchip Packaging Specification located at <http://www.microchip.com/packaging>



DETAIL C

| Dimension Limits         | Units | MILLIMETERS |      |      |
|--------------------------|-------|-------------|------|------|
|                          |       | MIN         | NOM  | MAX  |
| Number of Pins           | N     |             | 8    |      |
| Pitch                    | e     | 0.65 BSC    |      |      |
| Overall Height           | A     | -           | -    | 1.10 |
| Molded Package Thickness | A2    | 0.75        | 0.85 | 0.95 |
| Standoff                 | A1    | 0.00        | -    | 0.15 |
| Overall Width            | E     | 4.90 BSC    |      |      |
| Molded Package Width     | E1    | 3.00 BSC    |      |      |
| Overall Length           | D     | 3.00 BSC    |      |      |
| Foot Length              | L     | 0.40        | 0.60 | 0.80 |
| Footprint                | L1    | 0.95 REF    |      |      |
| Foot Angle               | φ     | 0°          | -    | 8°   |
| Lead Thickness           | c     | 0.08        | -    | 0.23 |
| Lead Width               | b     | 0.22        | -    | 0.40 |

**Notes:**

- Pin 1 visual index feature may vary, but must be located within the hatched area.
- Dimensions D and E1 do not include mold flash or protrusions. Mold flash or protrusions shall not exceed 0.15mm per side.
- Dimensioning and tolerancing per ASME Y14.5M.  
 BSC: Basic Dimension. Theoretically exact value shown without tolerances.  
 REF: Reference Dimension, usually without tolerance, for information purposes only.

Microchip Technology Drawing C04-111C Sheet 2 of 2

# MCP6546/6R/6U/7/8/9

## 14-Lead Plastic Small Outline (SL) - Narrow, 3.90 mm Body [SOIC]

**Note:** For the most current package drawings, please see the Microchip Packaging Specification located at <http://www.microchip.com/packaging>

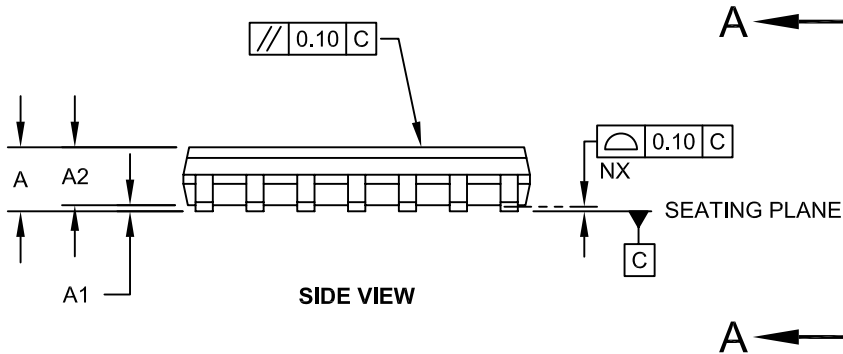
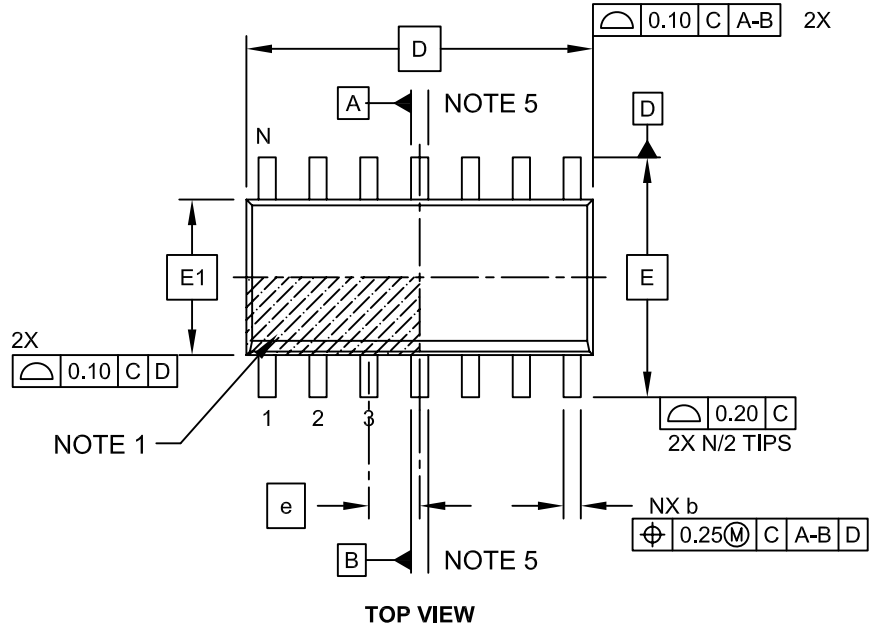

Microchip Technology Drawing No. C04-065C Sheet 1 of 2



# MCP6546/6R/6U/7/8/9

## 14-Lead Plastic Small Outline (SL) - Narrow, 3.90 mm Body [SOIC]

**Note:** For the most current package drawings, please see the Microchip Packaging Specification located at <http://www.microchip.com/packaging>



| Units                    |    | MILLIMETERS |     |      |
|--------------------------|----|-------------|-----|------|
| Dimension Limits         |    | MIN         | NOM | MAX  |
| Number of Pins           | N  | 14          |     |      |
| Pitch                    | e  | 1.27 BSC    |     |      |
| Overall Height           | A  | -           | -   | 1.75 |
| Molded Package Thickness | A2 | 1.25        | -   | -    |
| Standoff §               | A1 | 0.10        | -   | 0.25 |
| Overall Width            | E  | 6.00 BSC    |     |      |
| Molded Package Width     | E1 | 3.90 BSC    |     |      |
| Overall Length           | D  | 8.65 BSC    |     |      |
| Chamfer (Optional)       | h  | 0.25        | -   | 0.50 |
| Foot Length              | L  | 0.40        | -   | 1.27 |
| Footprint                | L1 | 1.04 REF    |     |      |
| Lead Angle               | θ  | 0°          | -   | -    |
| Foot Angle               | φ  | 0°          | -   | 8°   |
| Lead Thickness           | c  | 0.10        | -   | 0.25 |
| Lead Width               | b  | 0.31        | -   | 0.51 |
| Mold Draft Angle Top     | α  | 5°          | -   | 15°  |
| Mold Draft Angle Bottom  | β  | 5°          | -   | 15°  |

**Notes:**

- Pin 1 visual index feature may vary, but must be located within the hatched area.
- § Significant Characteristic
- Dimension D does not include mold flash, protrusions or gate burrs, which shall not exceed 0.15 mm per end. Dimension E1 does not include interlead flash or protrusion, which shall not exceed 0.25 mm per side.
- Dimensioning and tolerancing per ASME Y14.5M  
 BSC: Basic Dimension. Theoretically exact value shown without tolerances.  
 REF: Reference Dimension, usually without tolerance, for information purposes only.
- Datums A & B to be determined at Datum H.

Microchip Technology Drawing No. C04-065C Sheet 2 of 2

# MCP6546/6R/6U/7/8/9

14-Lead Plastic Small Outline (SL) - Narrow, 3.90 mm Body [SOIC]

**Note:** For the most current package drawings, please see the Microchip Packaging Specification located at <http://www.microchip.com/packaging>



RECOMMENDED LAND PATTERN

| Dimension Limits      | Units | MILLIMETERS |     |      |
|-----------------------|-------|-------------|-----|------|
|                       |       | MIN         | NOM | MAX  |
| Contact Pitch         | E     | 1.27 BSC    |     |      |
| Contact Pad Spacing   | C     | 5.40        |     |      |
| Contact Pad Width     | X     |             |     | 0.60 |
| Contact Pad Length    | Y     |             |     | 1.50 |
| Distance Between Pads | Gx    | 0.67        |     |      |
| Distance Between Pads | G     | 3.90        |     |      |

Notes:

1. Dimensioning and tolerancing per ASME Y14.5M

BSC: Basic Dimension. Theoretically exact value shown without tolerances.

Microchip Technology Drawing No. C04-2065A

# MCP6546/6R/6U/7/8/9

## 14-Lead Plastic Thin Shrink Small Outline (ST) - 4.4 mm Body [TSSOP]

**Note:** For the most current package drawings, please see the Microchip Packaging Specification located at <http://www.microchip.com/packaging>



# MCP6546/6R/6U/7/8/9

## 14-Lead Plastic Thin Shrink Small Outline (ST) - 4.4 mm Body [TSSOP]

**Note:** For the most current package drawings, please see the Microchip Packaging Specification located at <http://www.microchip.com/packaging>



| Dimension Limits         | Units     | MILLIMETERS |      |      |
|--------------------------|-----------|-------------|------|------|
|                          |           | MIN         | NOM  | MAX  |
| Number of Pins           | N         | 14          |      |      |
| Pitch                    | e         | 0.65 BSC    |      |      |
| Overall Height           | A         | -           | -    | 1.20 |
| Molded Package Thickness | A2        | 0.80        | 1.00 | 1.05 |
| Standoff                 | A1        | 0.05        | -    | 0.15 |
| Overall Width            | E         | 6.40 BSC    |      |      |
| Molded Package Width     | E1        | 4.30        | 4.40 | 4.50 |
| Molded Package Length    | D         | 4.90        | 5.00 | 5.10 |
| Foot Length              | L         | 0.45        | 0.60 | 0.75 |
| Footprint                | (L1)      | 1.00 REF    |      |      |
| Foot Angle               | $\varphi$ | 0°          | -    | 8°   |
| Lead Thickness           | c         | 0.09        | -    | 0.20 |
| Lead Width               | b         | 0.19        | -    | 0.30 |

**Notes:**

1. Pin 1 visual index feature may vary, but must be located within the hatched area.
2. Dimensions D and E1 do not include mold flash or protrusions. Mold flash or protrusions shall not exceed 0.15mm per side.
3. Dimensioning and tolerancing per ASME Y14.5M

BSC: Basic Dimension. Theoretically exact value shown without tolerances.

REF: Reference Dimension, usually without tolerance, for information purposes only.

Microchip Technology Drawing No. C04-087C Sheet 2 of 2

## 14-Lead Plastic Thin Shrink Small Outline (ST) - 4.4 mm Body [TSSOP]

**Note:** For the most current package drawings, please see the Microchip Packaging Specification located at <http://www.microchip.com/packaging>



### RECOMMENDED LAND PATTERN

| Dimension Limits         | Units | MILLIMETERS |      |      |
|--------------------------|-------|-------------|------|------|
|                          |       | MIN         | NOM  | MAX  |
| Contact Pitch            | E     | 0.65 BSC    |      |      |
| Contact Pad Spacing      | C1    |             | 5.90 |      |
| Contact Pad Width (X14)  | X1    |             |      | 0.45 |
| Contact Pad Length (X14) | Y1    |             |      | 1.45 |
| Distance Between Pads    | G     | 0.20        |      |      |

**Notes:**

1. Dimensioning and tolerancing per ASME Y14.5M

BSC: Basic Dimension. Theoretically exact value shown without tolerances.

Microchip Technology Drawing No. C04-2087A

# MCP6546/6R/6U/7/8/9

---

NOTES:

## APPENDIX A: REVISION HISTORY

### Revision G (February 2012)

The following is the list of modifications:

1. Updated the **Package Types** drawing to correct the device representation of the SC-70 package.
2. Updated package temperatures in the **Temperature Characteristics** table.
3. Corrected the marking information table for the 5-Lead SC-70 package (MCP6546 and MCP6546U) in **Section 5.1, Package Marking Information**.
4. Updated the package outline drawings in **Section 5.1 “Package Marking Information”**, to show all views for each package.
5. Minor editorial changes.

### Revision F (September 2007)

The following is the list of modifications:

1. Corrected polarity of MCP6546U SOT-23-5 pin-out diagram on the first page.
2. Updated package outline drawings in **Section 5.1 “Package Marking Information”** per Marcom.

### Revision E (September 2006)

The following is the list of modifications:

1. Added MCP6546U pinout for the SOT-23-5 package.
2. Clarified Absolute Maximum Analog Input Voltage and Current Specifications.
3. Added application information on unused comparators.
4. Added disclaimer to package outline drawings.

### Revision D (May 2006)

The following is the list of modifications:

1. Added E-temp parts.
2. Changed minimum pull-up voltage specification ( $V_{PU}$ ) to 1.6V for parts starting Dec. 2004 (week code 52); previous parts are specified at a minimum of  $V_{DD}$ .
3. Changed  $V_{HYST}$  temperature specifications to linear and quadratic temperature coefficients.
4. Changed specifications and plots to include E-Temp parts.
5. Added **Section 3.0 “Pin Descriptions”**.
6. Corrected package markings (**Section 5.1 “Package Marking Information”**).
7. Added **Appendix A: “Revision History”**.

### Revision C (May 2003)

- Undocumented changes.

### Revision B (December 2002)

- Undocumented changes.

### Revision A (February 2002)

- Original Release of this Document.

# MCP6546/6R/6U/7/8/9

---

NOTES:



# MCP6546/6R/6U/7/8/9

## PRODUCT IDENTIFICATION SYSTEM

To order or obtain information, e.g., on pricing or delivery, refer to the factory or the listed sales office.

| <u>PART NO.</u>  | <u>-X</u>         | <u>/XX</u> |   |
|--|-------------------|------------|---|
| Device   | Temperature Range | Package    |   |
| <p><b>Device:</b></p> <p>MCP6546: Single Comparator<br/> MCP6546T: Single Comparator (Tape and Reel) (SC-70, SOT-23, SOIC, MSOP)<br/> MCP6546RT: Single Comparator (Rotated - Tape and Reel) (SOT-23 only)<br/> MCP6546UT: Single Comparator (Tape and Reel) (SC-70, SOT-23)(<b>SOT-23-5 is E-Temp only</b>)<br/> MCP6547: Dual Comparator<br/> MCP6547T: Dual Comparator (Tape and Reel for SOIC and MSOP)<br/> MCP6548: Single Comparator with <math>\overline{CS}</math><br/> MCP6548T: Single Comparator with <math>\overline{CS}</math> (Tape and Reel for SOIC and MSOP)<br/> MCP6549: Quad Comparator<br/> MCP6549T: Quad Comparator (Tape and Reel for SOIC and TSSOP)</p> <p><b>Temperature Range:</b></p> <p>I = -40°C to +85°C<br/> E* = -40°C to +125°C<br/> * SC-70-5 E-Temp parts not available at this release of the data sheet.</p> <p><b>Package:</b></p> <p>LT = Plastic Package (SC-70), 5-lead<br/> OT = Plastic Small Outline Transistor (SOT-23), 5-lead<br/> MS = Plastic MSOP, 8-lead<br/> P = Plastic DIP (300 mil Body), 8-lead, 14-lead<br/> SN = Plastic SOIC (150 mil Body), 8-lead<br/> SL = Plastic SOIC (150 mil Body), 14-lead (MCP6549)<br/> ST = Plastic TSSOP (4.4mm Body), 14-lead (MCP6549)</p> |                   |            |   |
|  |                   |            | <p><b>Examples:</b></p> <p>a) MCP6546T-I/LT: Tape and Reel, Industrial Temperature, 5LD SC-70.<br/> b) MCP6546T-I/OT: Tape and Reel, Industrial Temperature, 5LD SOT-23.<br/> c) MCP6546-I/MS: Tape and Reel, Industrial Temperature, 8LD MSOP.<br/> d) MCP6546-E/P: Extended Temperature, 8LD PDIP.<br/> e) MCP6546-E/SN: Extended Temperature, 8LD SOIC.</p> <p>a) MCP6546RT-I/OT: Tape and Reel, Industrial Temperature, 5LD SOT23.</p> <p>a) MCP6546UT-E/LT: Tape and Reel, Industrial Temperature, 5LD SC-70<br/> b) MCP6546UT-E/OT: Tape and Reel, Extended Temperature, 5LD SOT23.</p> <p>a) MCP6547-I/MS: Industrial Temperature, 8LD MSOP.<br/> b) MCP6547T-I/MS: Tape and Reel, Industrial Temperature, 8LD MSOP.<br/> c) MCP6547-I/P: Industrial Temperature, 8LD PDIP.<br/> d) MCP6547-E/SN: Extended Temperature, 8LD SOIC.</p> <p>a) MCP6548-I/SN: Industrial Temperature, 8LD SOIC.<br/> b) MCP6548T-I/SN: Tape and Reel, Industrial Temperature, 8LD SOIC.<br/> c) MCP6548-I/P: Industrial Temperature, 8LD PDIP.<br/> d) MCP6548-E/SN: Extended Temperature, 8LD SOIC.</p> <p>a) MCP6549T-I/SL: Tape and Reel, Industrial Temperature, 14LD SOIC.<br/> b) MCP6549T-E/SL: Tape and Reel, Extended Temperature, 14LD SOIC.<br/> c) MCP6549-I/P: Industrial Temperature, 14LD PDIP.<br/> d) MCP6549-E/ST: Extended Temperature, 14LD TSSOP.</p> |

# MCP6546/6R/6U/7/8/9

---

NOTES:

---

**Note the following details of the code protection feature on Microchip devices:**

- Microchip products meet the specification contained in their particular Microchip Data Sheet.
- Microchip believes that its family of products is one of the most secure families of its kind on the market today, when used in the intended manner and under normal conditions.
- There are dishonest and possibly illegal methods used to breach the code protection feature. All of these methods, to our knowledge, require using the Microchip products in a manner outside the operating specifications contained in Microchip's Data Sheets. Most likely, the person doing so is engaged in theft of intellectual property.
- Microchip is willing to work with the customer who is concerned about the integrity of their code.
- Neither Microchip nor any other semiconductor manufacturer can guarantee the security of their code. Code protection does not mean that we are guaranteeing the product as “unbreakable.”

Code protection is constantly evolving. We at Microchip are committed to continuously improving the code protection features of our products. Attempts to break Microchip's code protection feature may be a violation of the Digital Millennium Copyright Act. If such acts allow unauthorized access to your software or other copyrighted work, you may have a right to sue for relief under that Act.

---

Information contained in this publication regarding device applications and the like is provided only for your convenience and may be superseded by updates. It is your responsibility to ensure that your application meets with your specifications. MICROCHIP MAKES NO REPRESENTATIONS OR WARRANTIES OF ANY KIND WHETHER EXPRESS OR IMPLIED, WRITTEN OR ORAL, STATUTORY OR OTHERWISE, RELATED TO THE INFORMATION, INCLUDING BUT NOT LIMITED TO ITS CONDITION, QUALITY, PERFORMANCE, MERCHANTABILITY OR FITNESS FOR PURPOSE. Microchip disclaims all liability arising from this information and its use. Use of Microchip devices in life support and/or safety applications is entirely at the buyer's risk, and the buyer agrees to defend, indemnify and hold harmless Microchip from any and all damages, claims, suits, or expenses resulting from such use. No licenses are conveyed, implicitly or otherwise, under any Microchip intellectual property rights.

**Trademarks**

The Microchip name and logo, the Microchip logo, dsPIC, KEELOQ, KEELOQ logo, MPLAB, PIC, PICmicro, PICSTART, PIC<sup>32</sup> logo, rfPIC and UNI/O are registered trademarks of Microchip Technology Incorporated in the U.S.A. and other countries.

FilterLab, Hampshire, HI-TECH C, Linear Active Thermistor, MXDEV, MXLAB, SEEVAL and The Embedded Control Solutions Company are registered trademarks of Microchip Technology Incorporated in the U.S.A.

Analog-for-the-Digital Age, Application Maestro, chipKIT, chipKIT logo, CodeGuard, dsPICDEM, dsPICDEM.net, dsPICworks, dsSPEAK, ECAN, ECONOMONITOR, FanSense, HI-TIDE, In-Circuit Serial Programming, ICSP, Mindi, MiWi, MPASM, MPLAB Certified logo, MPLIB, MPLINK, mTouch, Omniscient Code Generation, PICC, PICC-18, PICDEM, PICDEM.net, PICKit, PICtail, REAL ICE, rfLAB, Select Mode, Total Endurance, TSHARC, UniWinDriver, WiperLock and ZENA are trademarks of Microchip Technology Incorporated in the U.S.A. and other countries.

SQTP is a service mark of Microchip Technology Incorporated in the U.S.A.

All other trademarks mentioned herein are property of their respective companies.

© 2002-2012, Microchip Technology Incorporated, Printed in the U.S.A., All Rights Reserved.

 Printed on recycled paper.

ISBN: 978-1-62076-019-2

*Microchip received ISO/TS-16949:2009 certification for its worldwide headquarters, design and wafer fabrication facilities in Chandler and Tempe, Arizona; Gresham, Oregon and design centers in California and India. The Company's quality system processes and procedures are for its PIC<sup>®</sup> MCUs and dsPIC<sup>®</sup> DSCs, KEELOQ<sup>®</sup> code hopping devices, Serial EEPROMs, microperipherals, nonvolatile memory and analog products. In addition, Microchip's quality system for the design and manufacture of development systems is ISO 9001:2000 certified.*

**QUALITY MANAGEMENT SYSTEM**  
**CERTIFIED BY DNV**  
**== ISO/TS 16949:2009 ==**



# MICROCHIP

## Worldwide Sales and Service

### AMERICAS

**Corporate Office**  
2355 West Chandler Blvd.  
Chandler, AZ 85224-6199  
Tel: 480-792-7200  
Fax: 480-792-7277  
Technical Support:  
<http://www.microchip.com/support>  
Web Address:  
[www.microchip.com](http://www.microchip.com)

**Atlanta**  
Duluth, GA  
Tel: 678-957-9614  
Fax: 678-957-1455

**Boston**  
Westborough, MA  
Tel: 774-760-0087  
Fax: 774-760-0088

**Chicago**  
Itasca, IL  
Tel: 630-285-0071  
Fax: 630-285-0075

**Cleveland**  
Independence, OH  
Tel: 216-447-0464  
Fax: 216-447-0643

**Dallas**  
Addison, TX  
Tel: 972-818-7423  
Fax: 972-818-2924

**Detroit**  
Farmington Hills, MI  
Tel: 248-538-2250  
Fax: 248-538-2260

**Indianapolis**  
Noblesville, IN  
Tel: 317-773-8323  
Fax: 317-773-5453

**Los Angeles**  
Mission Viejo, CA  
Tel: 949-462-9523  
Fax: 949-462-9608

**Santa Clara**  
Santa Clara, CA  
Tel: 408-961-6444  
Fax: 408-961-6445

**Toronto**  
Mississauga, Ontario,  
Canada  
Tel: 905-673-0699  
Fax: 905-673-6509

### ASIA/PACIFIC

**Asia Pacific Office**  
Suites 3707-14, 37th Floor  
Tower 6, The Gateway  
Harbour City, Kowloon  
Hong Kong  
Tel: 852-2401-1200  
Fax: 852-2401-3431

**Australia - Sydney**  
Tel: 61-2-9868-6733  
Fax: 61-2-9868-6755

**China - Beijing**  
Tel: 86-10-8569-7000  
Fax: 86-10-8528-2104

**China - Chengdu**  
Tel: 86-28-8665-5511  
Fax: 86-28-8665-7889

**China - Chongqing**  
Tel: 86-23-8980-9588  
Fax: 86-23-8980-9500

**China - Hangzhou**  
Tel: 86-571-2819-3187  
Fax: 86-571-2819-3189

**China - Hong Kong SAR**  
Tel: 852-2401-1200  
Fax: 852-2401-3431

**China - Nanjing**  
Tel: 86-25-8473-2460  
Fax: 86-25-8473-2470

**China - Qingdao**  
Tel: 86-532-8502-7355  
Fax: 86-532-8502-7205

**China - Shanghai**  
Tel: 86-21-5407-5533  
Fax: 86-21-5407-5066

**China - Shenyang**  
Tel: 86-24-2334-2829  
Fax: 86-24-2334-2393

**China - Shenzhen**  
Tel: 86-755-8203-2660  
Fax: 86-755-8203-1760

**China - Wuhan**  
Tel: 86-27-5980-5300  
Fax: 86-27-5980-5118

**China - Xian**  
Tel: 86-29-8833-7252  
Fax: 86-29-8833-7256

**China - Xiamen**  
Tel: 86-592-2388138  
Fax: 86-592-2388130

**China - Zhuhai**  
Tel: 86-756-3210040  
Fax: 86-756-3210049

### ASIA/PACIFIC

**India - Bangalore**  
Tel: 91-80-3090-4444  
Fax: 91-80-3090-4123

**India - New Delhi**  
Tel: 91-11-4160-8631  
Fax: 91-11-4160-8632

**India - Pune**  
Tel: 91-20-2566-1512  
Fax: 91-20-2566-1513

**Japan - Osaka**  
Tel: 81-66-152-7160  
Fax: 81-66-152-9310

**Japan - Yokohama**  
Tel: 81-45-471-6166  
Fax: 81-45-471-6122

**Korea - Daegu**  
Tel: 82-53-744-4301  
Fax: 82-53-744-4302

**Korea - Seoul**  
Tel: 82-2-554-7200  
Fax: 82-2-558-5932 or  
82-2-558-5934

**Malaysia - Kuala Lumpur**  
Tel: 60-3-6201-9857  
Fax: 60-3-6201-9859

**Malaysia - Penang**  
Tel: 60-4-227-8870  
Fax: 60-4-227-4068

**Philippines - Manila**  
Tel: 63-2-634-9065  
Fax: 63-2-634-9069

**Singapore**  
Tel: 65-6334-8870  
Fax: 65-6334-8850

**Taiwan - Hsin Chu**  
Tel: 886-3-5778-366  
Fax: 886-3-5770-955

**Taiwan - Kaohsiung**  
Tel: 886-7-536-4818  
Fax: 886-7-330-9305

**Taiwan - Taipei**  
Tel: 886-2-2500-6610  
Fax: 886-2-2508-0102

**Thailand - Bangkok**  
Tel: 66-2-694-1351  
Fax: 66-2-694-1350

### EUROPE

**Austria - Wels**  
Tel: 43-7242-2244-39  
Fax: 43-7242-2244-393

**Denmark - Copenhagen**  
Tel: 45-4450-2828  
Fax: 45-4485-2829

**France - Paris**  
Tel: 33-1-69-53-63-20  
Fax: 33-1-69-30-90-79

**Germany - Munich**  
Tel: 49-89-627-144-0  
Fax: 49-89-627-144-44

**Italy - Milan**  
Tel: 39-0331-742611  
Fax: 39-0331-466781

**Netherlands - Drunen**  
Tel: 31-416-690399  
Fax: 31-416-690340

**Spain - Madrid**  
Tel: 34-91-708-08-90  
Fax: 34-91-708-08-91

**UK - Wokingham**  
Tel: 44-118-921-5869  
Fax: 44-118-921-5820

11/29/11