

150 mA Low Noise μ Cap CMOS LDO

Features

- Input Voltage Range: 2.7V to 6.0V
- Thin SOT Package: 1 mm Height SOT-23-5
- Ultra-Low Output Noise: 30 μ V_{RMS}
- Stability with Ceramic Output Capacitors
- Ultra-Low Dropout: 135 mV @ 150 mA
- High output accuracy:
 - 1.0% Initial Accuracy
 - 2.0% Over Temperature
- Low Quiescent Current: 90 μ A
- Tight Load and Line Regulation
- TTL-Logic-Controlled Enable Input
- “Zero” Off-Mode Current
- Thermal Shutdown and Current-Limit Protection

Applications

- Cellular Telephones and Pagers
- Cellular Accessories
- Battery-Powered Equipment
- Laptop, Notebook, and Palmtop Computers
- Consumer/Personal Electronics

General Description

The MIC5255 is an efficient, precise CMOS voltage regulator optimized for ultra-low-noise applications. It offers 1% initial accuracy, extremely-low dropout voltage (135 mV at 150 mA) and low ground current (typically 117 μ A at full load). The MIC5255 provides a very low noise output, ideal for RF applications where a clean voltage source is required. A noise bypass pin is also available for further reduction of output noise.

Designed specifically for handheld and battery powered devices, the MIC5255 provides a TTL-logic-compatible enable pin. When disabled, power consumption drops nearly to zero.

The MIC5255 also works with low-ESR ceramic capacitors, reducing the amount of board space necessary for power applications, critical in handheld wireless devices.

Key features include current limit, thermal shutdown, faster transient response, and an active clamp to speed up device turn-off. Available in the 6-pin 2 mm \times 2 mm VDFN package, the SOT-23-5 package and the Thin SOT-23-5, which offers the same footprint as the standard SOT-23-5, but is only 1 mm tall. The MIC5255 offers a range of output voltages.

Package Types

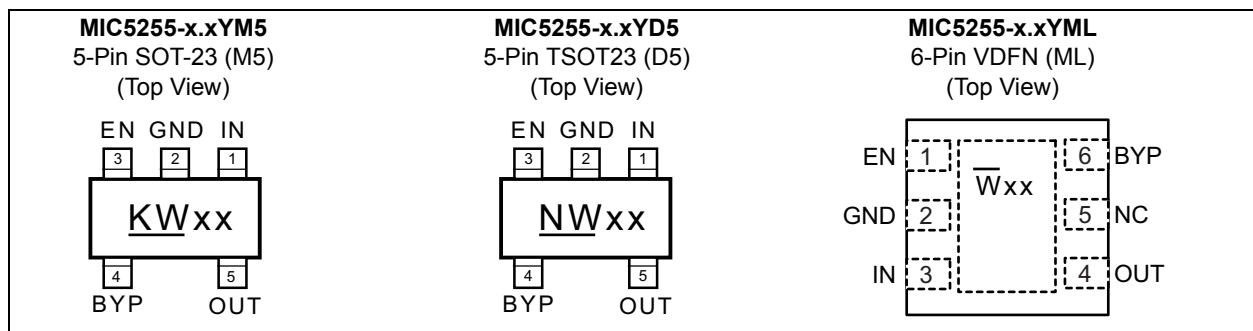

MIC5255

Typical Application Schematic

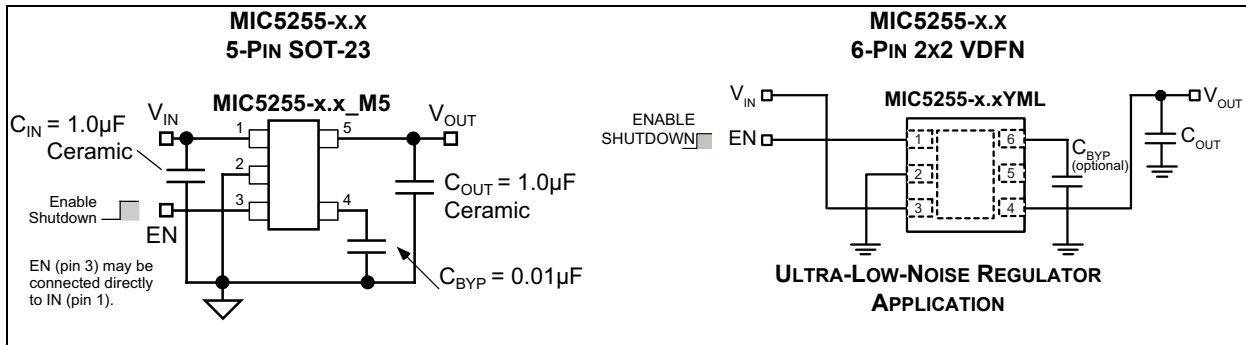

Block Diagram

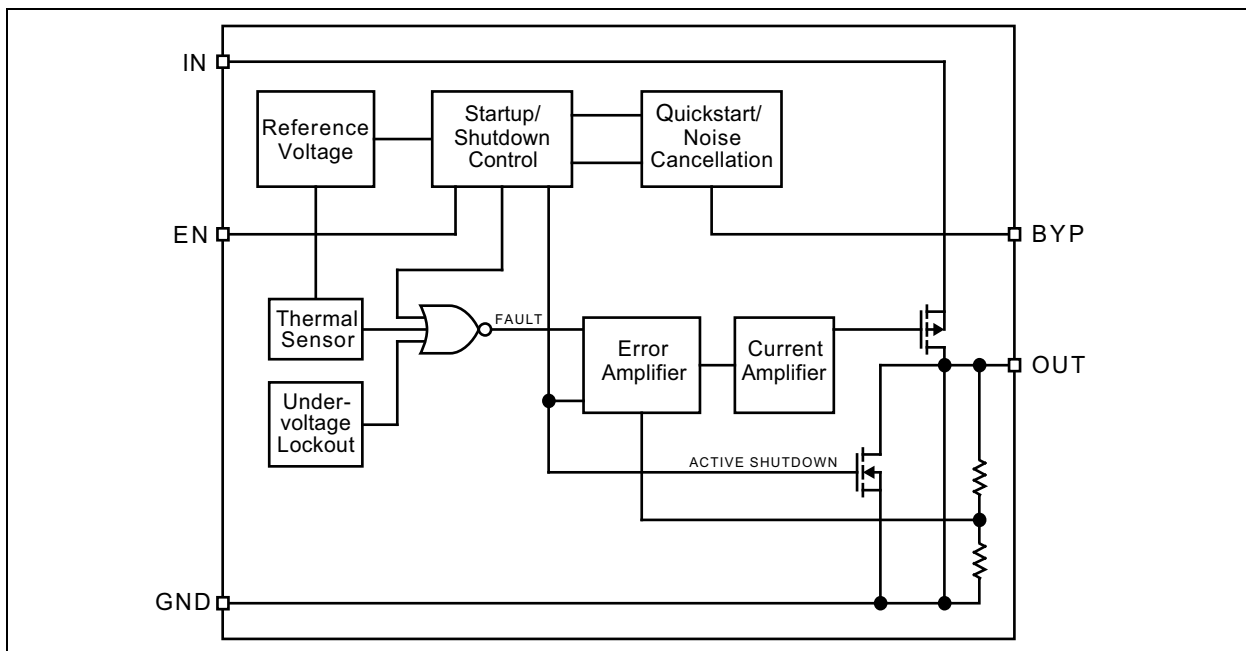

1.0 ELECTRICAL CHARACTERISTICS

Absolute Maximum Ratings †

Supply Voltage (V_{IN})	0V to +7V
Enable Voltage (V_{EN})	0V to +7V
Power Dissipation (P_D , Note 1)	Internally Limited
ESD Rating (Note 2)	2 kV

Operating Ratings ‡

Supply Voltage (V_{IN})	+2.7V to +6V
Enable Voltage (V_{EN})	0V to V_{IN}

† **Notice:** Stresses above those listed under “Absolute Maximum Ratings” may cause permanent damage to the device. This is a stress rating only and functional operation of the device at those or any other conditions above those indicated in the operational sections of this specification is not intended. Exposure to maximum rating conditions for extended periods may affect device reliability.

‡ **Notice:** The device is not guaranteed to function outside its operating ratings.

Note 1: The maximum allowable power dissipation of any T_A (ambient temperature) is $P_{D(max)} = (T_{J(max)} - T_A) / \theta_{JA}$. Exceeding the maximum allowable power dissipation will result in excessive die temperature, and the regulator will go into thermal shutdown. The θ_{JA} of the MIC5255-x.xYM5 (all versions) is 235°C/W on a PC board. See the [Thermal Considerations](#) section for further details.

2: Devices are ESD sensitive. Handling precautions recommended. Human body model, 1.5 kΩ in series with 100 pF.

MIC5255

TABLE 1-1: ELECTRICAL CHARACTERISTICS

Electrical Characteristics: $V_{IN} = V_{OUT} + 1V$, $V_{EN} = V_{IN}$; $I_{OUT} = 100 \mu A$; $T_J = 25^\circ C$, bold values indicate $-40^\circ C \leq T_J \leq +125^\circ C$; unless noted. (Note 1).						
Parameters	Sym.	Min.	Typ.	Max.	Units	Conditions
Output Voltage Accuracy	V_O	-1	—	1	%	$I_{OUT} = 100 \mu A$
		-2	—	2		
Line Regulation	ΔV_{LNR}	—	0.02	0.05	%/V	$V_{IN} = V_{OUT} + 1V$ to 6V
Load Regulation	ΔV_{LDR}	—	1.5	2.5	%	$I_{OUT} = 0.1$ mA to 150 mA; Note 2
Dropout Voltage, Note 3	$V_{IN} - V_{OUT}$	—	0.1	5	mV	$I_{OUT} = 100 \mu A$
		—	90	150		$I_{OUT} = 100$ mA
		—	135	200		$I_{OUT} = 150$ mA
		—	—	250		
Quiescent Current	I_Q	—	0.2	5	μA	$V_{EN} \leq 0.4V$ (shutdown)
Ground Pin Current, Note 4	I_{GND}	—	90	150	μA	$I_{OUT} = 0$ mA
		—	117	—		$I_{OUT} = 150$ mA
Ripple Rejection	PSRR	—	60	—	dB	$f = 10$ Hz, $C_{OUT} = 1.0 \mu F$, $C_{BYP} = 0.01 \mu F$
		—	60	—		$f = 100$ Hz, $V_{IN} = V_{OUT} + 1V$
		—	50	—		$f = 10$ kHz, $V_{IN} = V_{OUT} + 1V$
Current Limit	I_{LIM}	160	425	—	mA	$V_{OUT} = 0V$
Output Voltage Noise	e_n	—	30	—	μV_{RMS}	$C_{OUT} = 1.0 \mu F$, $C_{BYP} = 0.01 \mu F$, $f = 10$ Hz to 100 kHz
Enable Input						
Enable Input Logic-Low Voltage	V_{IL}	—	—	0.4	V	$V_{IN} = 2.7V$ to 5.5V, regulator shutdown
Enable Input Logic-High Voltage	V_{IH}	1.6	—	—	V	$V_{IN} = 2.7V$ to 5.5V, regulator enabled
Enable Input Current	I_{EN}	—	0.01	—	μA	$V_{IL} \leq 0.4V$, regulator shutdown
		—	0.01	—	μA	$V_{IH} \geq 1.6V$, regulator enabled
Shutdown Resistance Discharge	—	—	500	—	Ω	—
Thermal Protection						
Thermal Shutdown Temperature	—	—	150	—	$^\circ C$	—
Thermal Shutdown Hysteresis	—	—	10	—	$^\circ C$	—

Note 1: Specification for packaged product only.

2: Regulation is measured at constant junction temperature using low duty cycle pulse testing. Parts are tested for load regulation in the load range from 1.0 mA to 150 mA. Changes in output voltage due to heating effects are covered by the thermal regulation specification.

3: Dropout voltage is defined as the input to output differential at which the output voltage drops 2% below its nominal value measured at 1V differential. For outputs below 2.7V, dropout voltage is the input-to-output voltage differential with the minimum input voltage 2.7V. Minimum input operating voltage is 2.7V.

4: Ground pin current is the regulator quiescent current. The total current drawn from the supply is the sum of the load current plus the ground pin current.

TEMPERATURE SPECIFICATIONS

Parameters	Sym.	Min.	Typ.	Max.	Units	Conditions
Temperature Ranges						
Junction Operating Temperature Range	T_J	-40	—	+125	°C	Note 1
Storage Temperature	T_S	-60	—	+150	°C	—
Lead Temperature	—	—	—	+260	°C	Soldering, 5s
Package Thermal Resistances						
Thermal Resistance, SOT-23-5	θ_{JA}	—	235	—	°C/W	—
Thermal Resistance, 2x2 VDFN-6	θ_{JA}	—	90	—	°C/W	—

Note 1: The maximum allowable power dissipation is a function of ambient temperature, the maximum allowable junction temperature and the thermal resistance from junction to air (i.e., T_A , T_J , θ_{JA}). Exceeding the maximum allowable power dissipation will cause the device operating junction temperature to exceed the maximum +125°C rating. Sustained junction temperatures above +125°C can impact the device reliability.

2.0 TYPICAL PERFORMANCE CURVES

Note: The graphs and tables provided following this note are a statistical summary based on a limited number of samples and are provided for informational purposes only. The performance characteristics listed herein are not tested or guaranteed. In some graphs or tables, the data presented may be outside the specified operating range (e.g., outside specified power supply range) and therefore outside the warranted range.

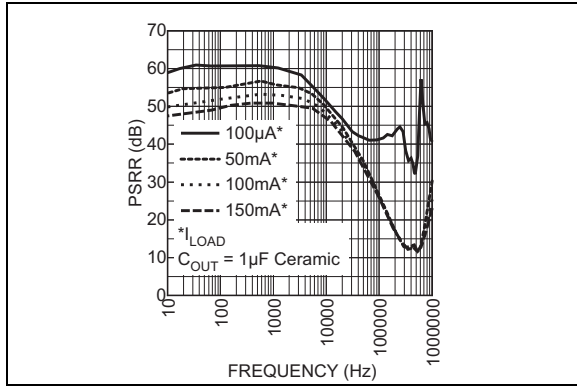

FIGURE 2-1: Power Supply Rejection Ratio.

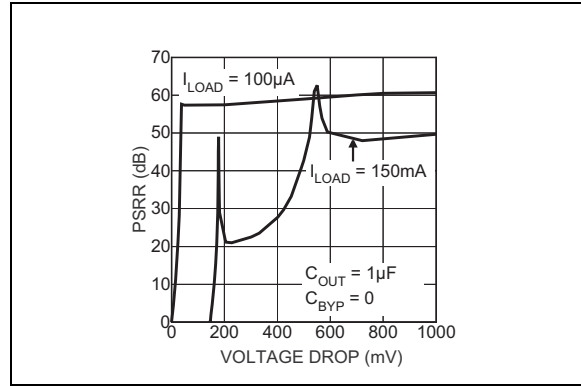

FIGURE 2-4: PSRR vs. Voltage Drop.

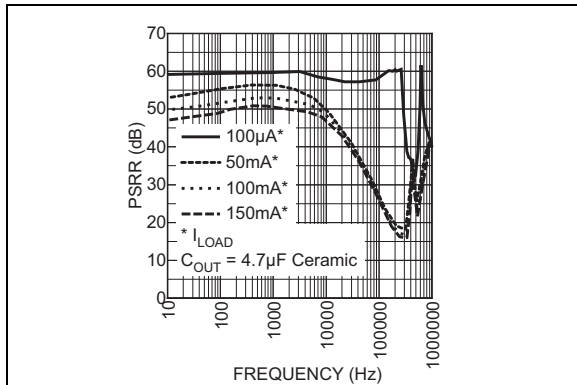

FIGURE 2-2: Power Supply Rejection Ratio.

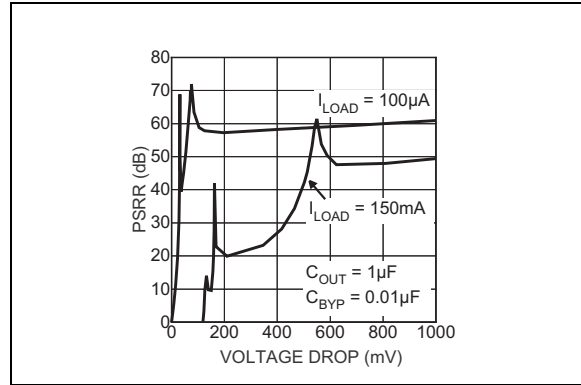

FIGURE 2-5: PSRR vs. Voltage Drop.

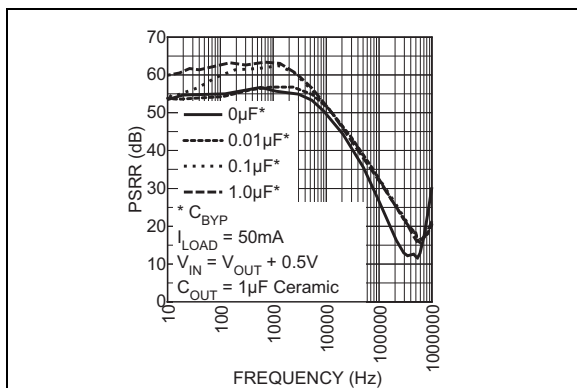

FIGURE 2-3: Power Supply Rejection Ratio.

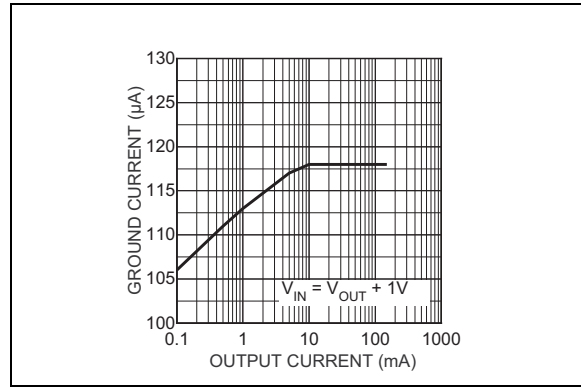

FIGURE 2-6: Ground Pin Current.

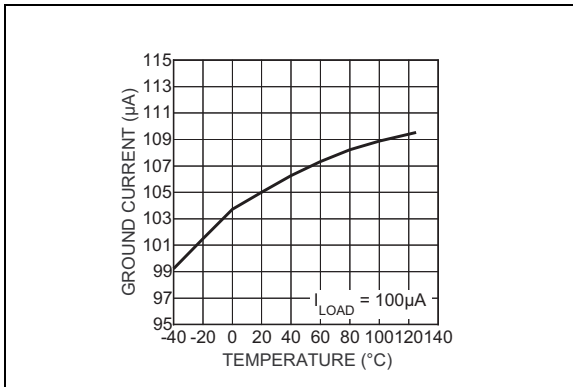

FIGURE 2-7: Ground Pin Current.

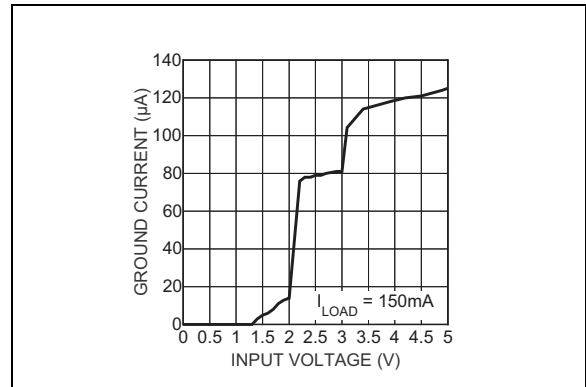

FIGURE 2-10: Ground Pin Current.

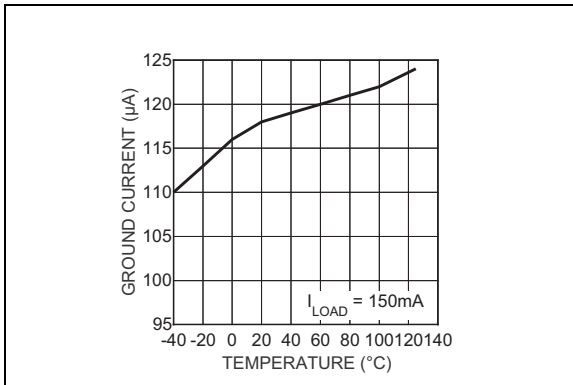

FIGURE 2-8: Ground Pin Current.

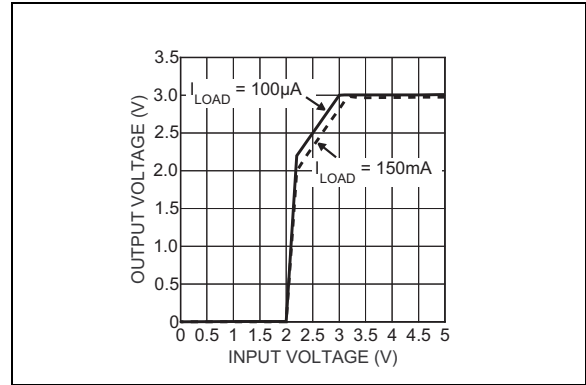

FIGURE 2-11: Dropout Characteristics.

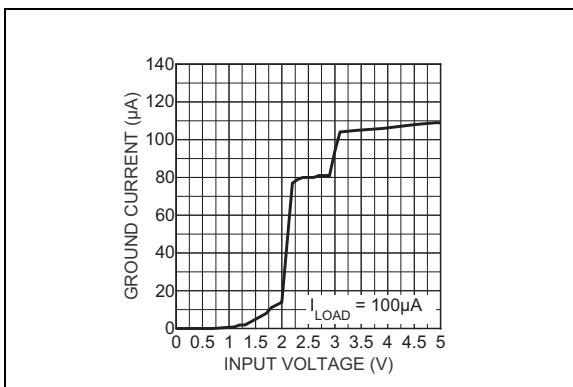

FIGURE 2-9: Ground Pin Current.

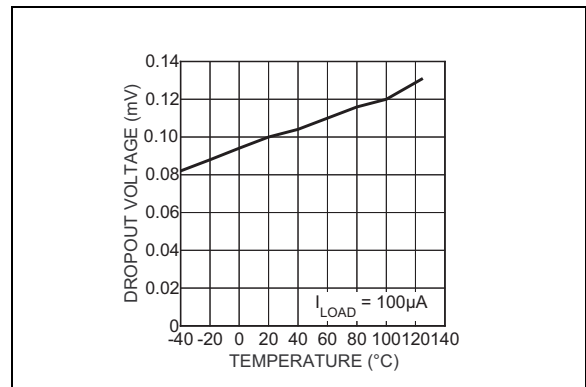

FIGURE 2-12: Dropout Voltage.

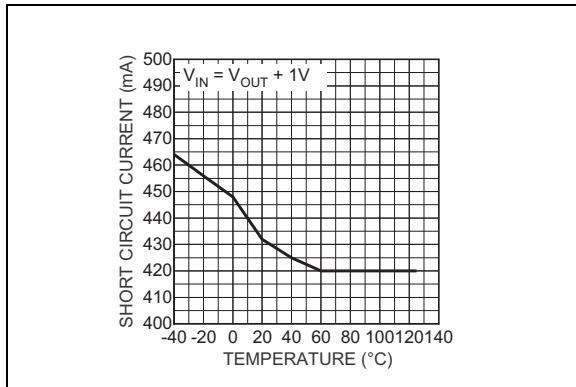

FIGURE 2-13: Short Circuit Current.

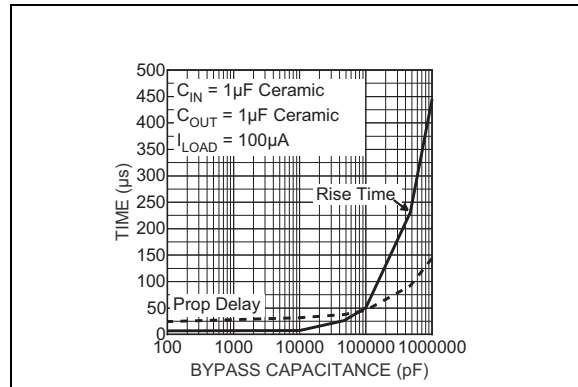

FIGURE 2-16: Turn-On Time vs. Bypass Capacitance.

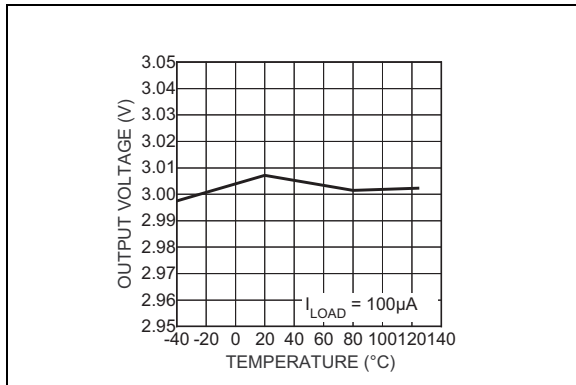

FIGURE 2-14: Output Voltage vs. Temperature.

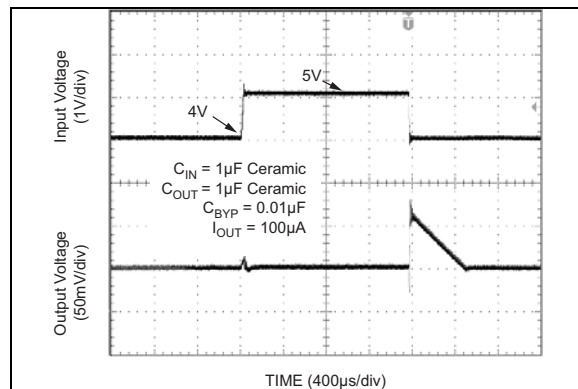

FIGURE 2-17: Line Transient Response.

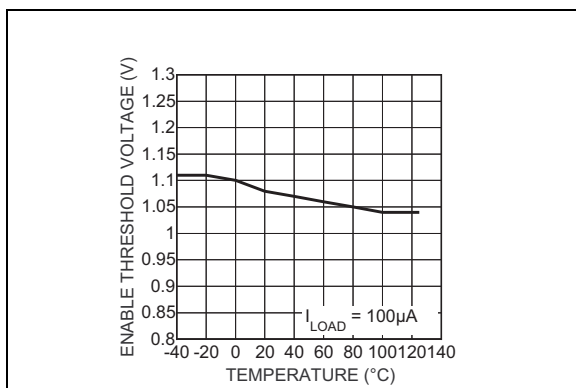

FIGURE 2-15: Enable Threshold vs. Temperature.

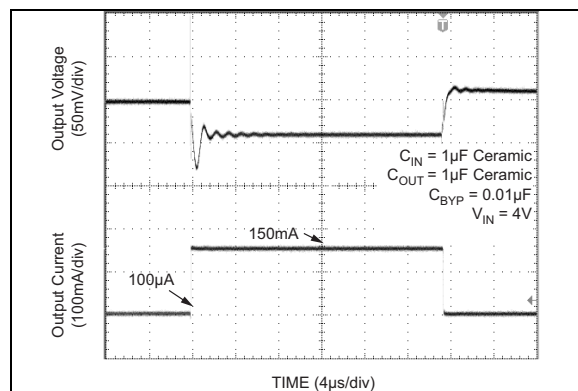

FIGURE 2-18: Load Transient Response.

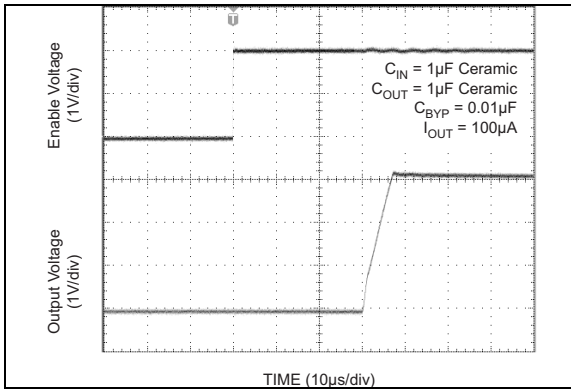

FIGURE 2-19: Enable Pin Delay.

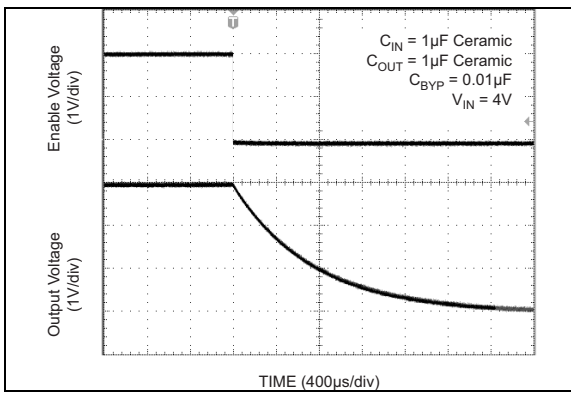

FIGURE 2-20: Shutdown Delay.

MIC5255

3.0 PIN DESCRIPTIONS

The descriptions of the pins are listed in [Table 3-1](#).

TABLE 3-1: PIN FUNCTION TABLE

Pin Number SOT23-5 TSOT23-5	Pin Number VDFN-6	Pin Name	Description
1	3	IN	Supply Input.
2	2	GND	Ground.
3	1	EN	Enable/Shutdown (Input): CMOS-compatible input. Logic-high = enable; logic-low = shutdown. Do not leave open.
4	6	BYP	Reference Bypass: Connect external $0.01 \mu\text{F} \leq C_{\text{BYP}} \leq 1.0 \mu\text{F}$ capacitor to GND to reduce output noise. May be left open.
5	4	OUT	Regulator Output.
—	5	NC	No internal connection.
—	EP	GND	Ground: Internally connected to the exposed pad. Connect externally to GND pin.

4.0 APPLICATION INFORMATION

4.1 Enable Shutdown

The MIC5255 comes with an active-high enable pin that allows the regulator to be disabled. Forcing the enable pin low disables the regulator and sends it into a “zero” off-mode current state. In this state, current consumed by the regulator goes nearly to zero. Forcing the enable pin high enables the output voltage. This part is CMOS and the enable pin cannot be left floating; a floating enable pin may cause an indeterminate state on the output.

4.2 Input Capacitor

The MIC5255 is a high performance, high bandwidth device. Therefore, it requires a well-bypassed input supply for optimal performance. A 1 μ F capacitor is required from the input to ground to provide stability. Low-ESR ceramic capacitors provide optimal performance at a minimum of space. Additional high frequency capacitors, such as small valued NPO dielectric type capacitors, help filter out high frequency noise and are good practice in any RF-based circuit.

4.3 Output Capacitor

The MIC5255 requires an output capacitor for stability. The design requires 1 μ F or greater on the output to maintain stability. The design is optimized for use with low-ESR ceramic chip capacitors. High ESR capacitors may cause high frequency oscillation. The maximum recommended ESR is 300 m Ω . The output capacitor can be increased, but performance has been optimized for a 1 μ F ceramic output capacitor and does not improve significantly with larger capacitance.

X7R/X5R dielectric-type ceramic capacitors are recommended because of their temperature performance. X7R-type capacitors change capacitance by 15% over their operating temperature range and are the most stable type of ceramic capacitors. Z5U and Y5V dielectric capacitors change value by as much as 50% and 60%, respectively, over their operating temperature ranges. To use a ceramic chip capacitor with Y5V dielectric, the value must be much higher than an X7R ceramic capacitor to ensure the same minimum capacitance over the equivalent operating temperature range.

4.4 Bypass Capacitor

A capacitor can be placed from the noise bypass pin to ground to reduce output voltage noise. The capacitor bypasses the internal reference. A 0.01 μ F capacitor is recommended for applications that require low-noise outputs. The bypass capacitor can be increased, further reducing noise and improving PSRR. Turn-on time increases slightly with respect to bypass capacitance. A unique quick-start circuit allows the

MIC5255 to drive a large capacitor on the bypass pin without significantly slowing turn-on time. Refer to the [Typical Performance Curves](#) section for performance with different bypass capacitors.

4.5 Active Shutdown

The MIC5255 also features an active shutdown clamp, which is an N-Channel MOSFET that turns on when the device is disabled. This allows the output capacitor and load to discharge, de-energizing the load.

4.6 No-Load Stability

The MIC5255 will remain stable and in regulation with no load unlike many other voltage regulators. This is especially important in CMOS RAM keep-alive applications.

4.7 Thermal Considerations

The MIC5255 is designed to provide 150 mA of continuous current in a very small package. Maximum power dissipation can be calculated based on the output current and the voltage drop across the part. To determine the maximum power dissipation of the package, use the junction-to-ambient thermal resistance of the device and the following basic equation:

EQUATION 4-1:

$$P_{D(MAX)} = \left(\frac{T_{J(MAX)} - T_A}{\theta_{JA}} \right)$$

$T_{J(MAX)}$ is the maximum junction temperature of the die, 125°C, and T_A is the ambient operating temperature. θ_{JA} is layout dependent; [Table 4-1](#) shows examples of junction-to-ambient thermal resistance for the MIC5255.

TABLE 4-1: SOT23-5 THERMAL RESISTANCE

Package	θ_{JA} Recommended Minimum Footprint	θ_{JA} 1” Square Copper Clad	θ_{JC}
SOT23-5 (M5 or D5)	235°C/W	185°C/W	145°C/W

The actual power dissipation of the regulator circuit can be determined using the equation:

MIC5255

EQUATION 4-2:

$$P_D = (V_{IN} - V_{OUT})I_{OUT} + V_{IN} \times I_{GND}$$

Substituting $P_{D(MAX)}$ for P_D and solving for the operating conditions that are critical to the application will give the maximum operating conditions for the regulator circuit. For example, when operating the MIC5255-3.0YM5 at +50°C with a minimum footprint layout, the maximum input voltage for a set output current can be determined as follows:

EQUATION 4-3:

$$P_{D(MAX)} = \left(\frac{125^\circ C - 50^\circ C}{235^\circ C/W} \right) = 319mW$$

The junction-to-ambient thermal resistance for the minimum footprint is 235°C/W, from [Table 4-1](#). The maximum power dissipation must not be exceeded for proper operation. Using the output voltage of 3.0V and an output current of 150 mA, the maximum input voltage can be determined for the series of equations between [Equation 4-4](#) and [Equation 4-7](#). Because this device is CMOS and the ground current is typically 100 µA over the load range, the power dissipation contributed by the ground current is <1% and can be ignored for this calculation:

EQUATION 4-4:

$$319mW = (V_{IN} - 3.0V) \times 150mA$$

EQUATION 4-5:

$$319mW = V_{IN} \times 150mA - 450mW$$

EQUATION 4-6:

$$769mW = V_{IN} \times 150mA$$

EQUATION 4-7:

$$V_{IN(MAX)} = 5.12V$$

Therefore, a 3.0V application at 150 mA of output current can accept a maximum input voltage of 5.12V in a SOT23-5 package.

5.0 PACKAGING INFORMATION

5.1 Package Marking Information

5-Pin TSOT-23*

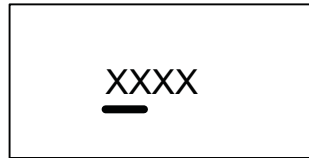

Example

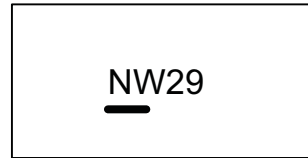

5-Pin SOT-23*



Example

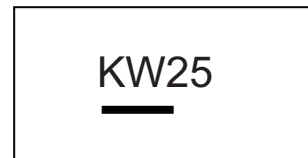

6-Pin VDFN*

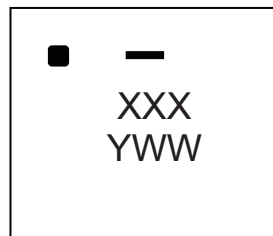

Example



Legend:	XX...X	Product code or customer-specific information
	Y	Year code (last digit of calendar year)
	YY	Year code (last 2 digits of calendar year)
	WW	Week code (week of January 1 is week '01')
	NNN	Alphanumeric traceability code
	(e3)	Pb-free JEDEC® designator for Matte Tin (Sn)
	*	This package is Pb-free. The Pb-free JEDEC designator ((e3)) can be found on the outer packaging for this package.
	•, ▲, ▼	Pin one index is identified by a dot, delta up, or delta down (triangle mark).
Note:	In the event the full Microchip part number cannot be marked on one line, it will be carried over to the next line, thus limiting the number of available characters for customer-specific information. Package may or may not include the corporate logo.	
	Underbar (_) and/or Overbar (¯) symbol may not be to scale.	

MIC5255

5-Pin SOT-23 Package Outline and Recommended Land Pattern

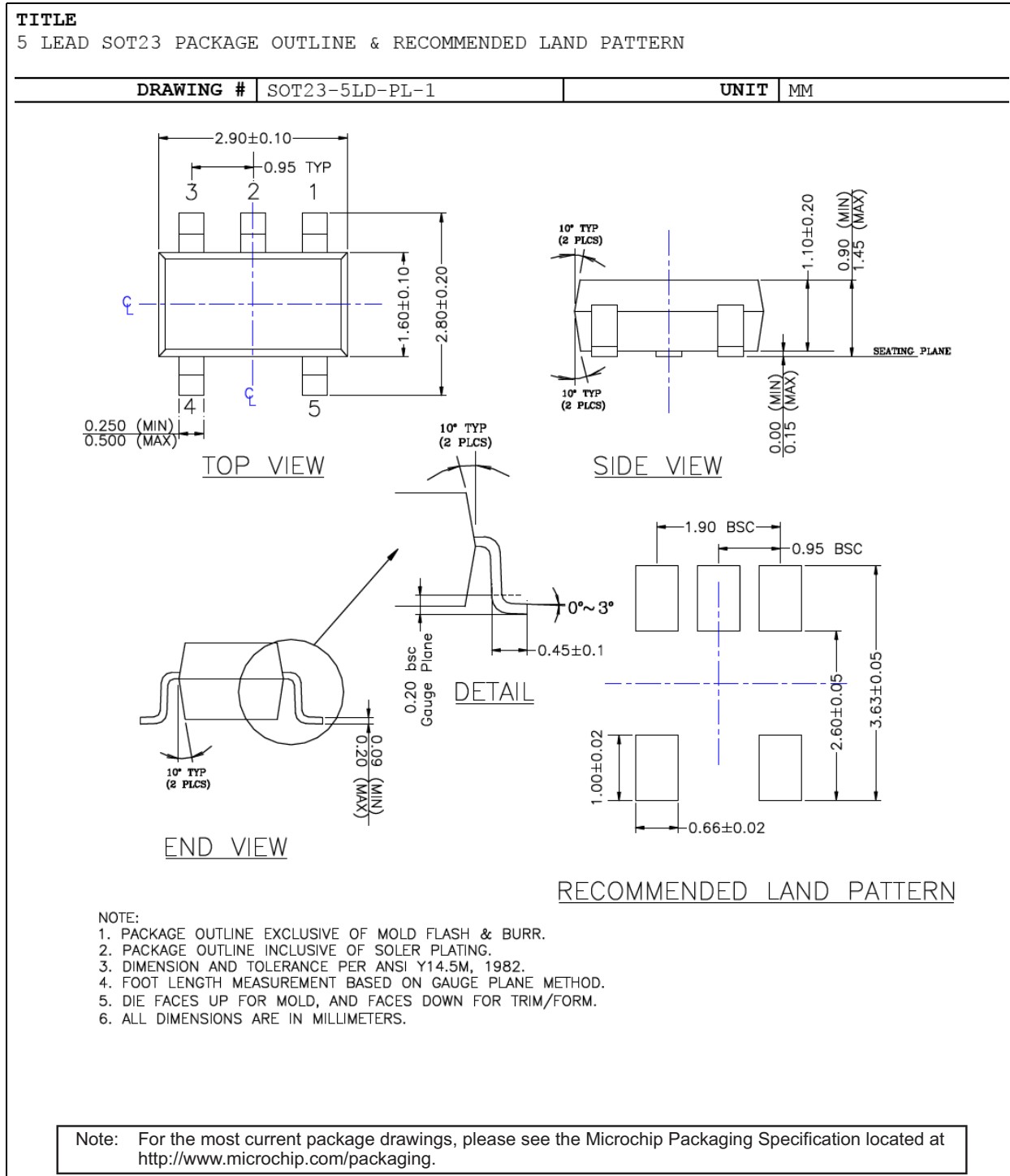

5-Pin TSOT-23 Package Outline and Recommended Land Pattern

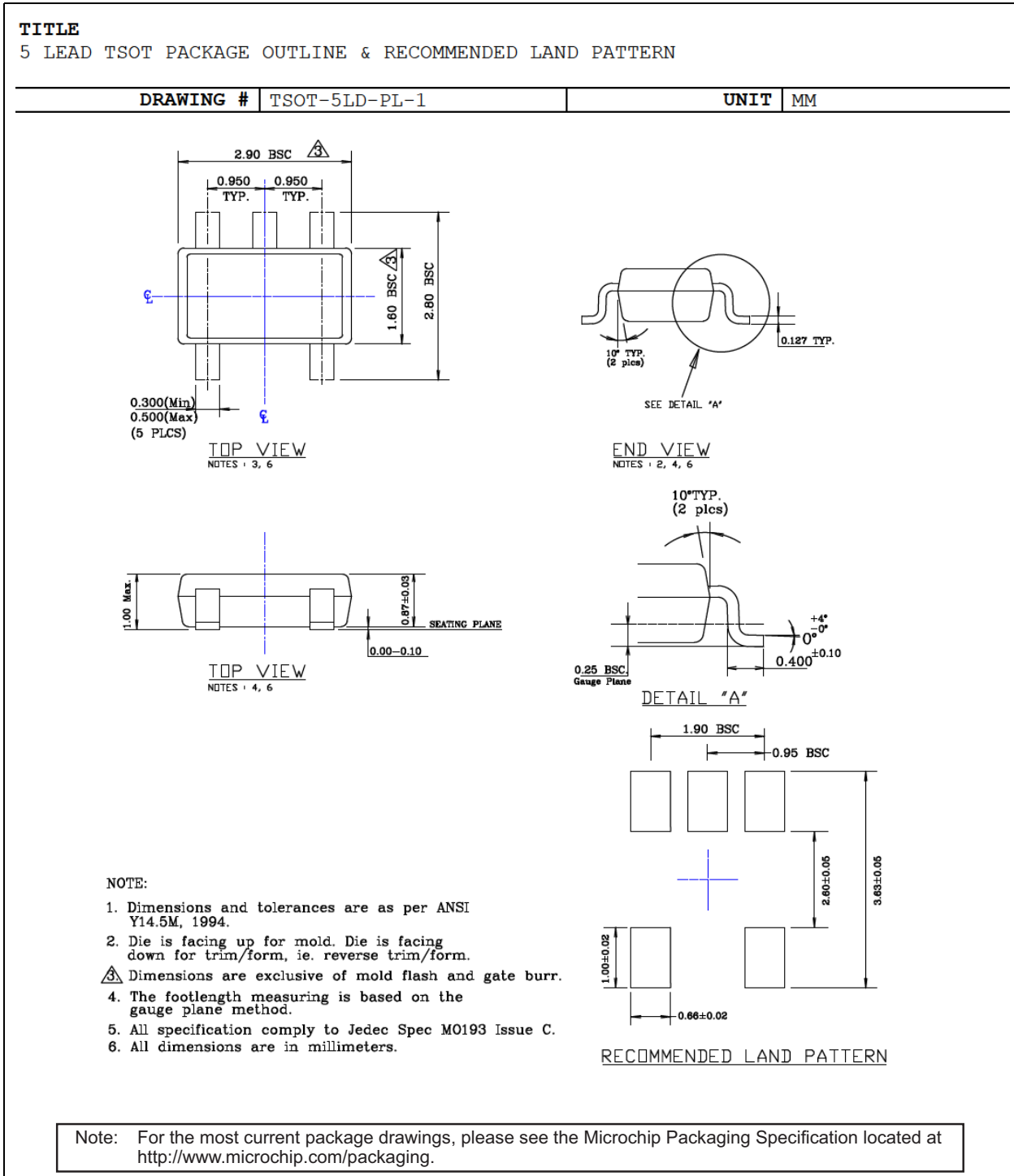

MIC5255

6-Pin 2 mm x 2 mm VDFN Package Outline and Recommended Land Pattern

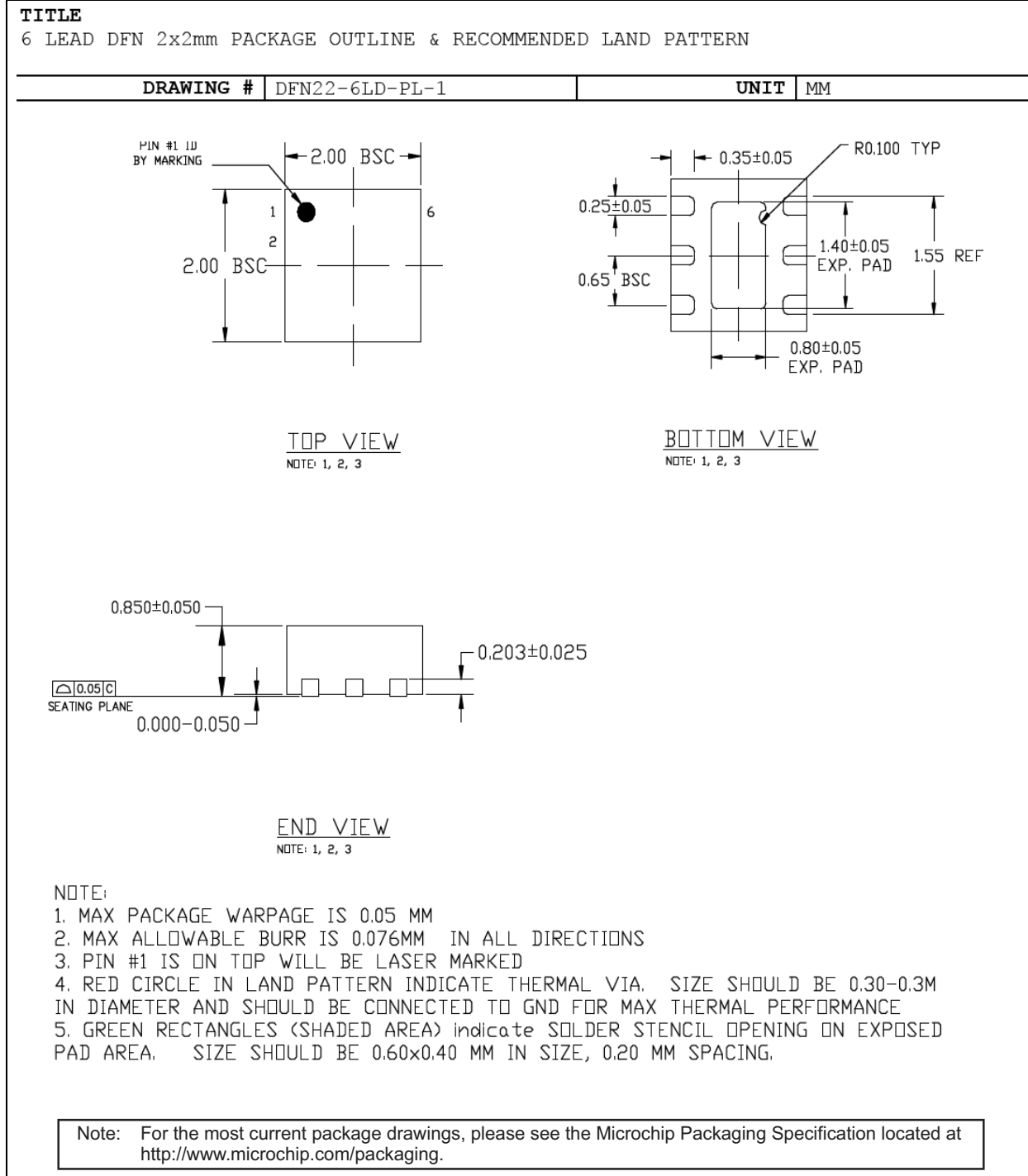

APPENDIX A: REVISION HISTORY

Revision A (November 2016)

- Converted Micrel document MIC5255 to Microchip data sheet DS20005661A.
- Minor text changes throughout.
- Leaded parts (B-designated) removed from data sheet.
- Voltage options updated in the [Product Identification System](#) section.
- DFN package naming updated to Microchip-standard VDFN package.
- Typical ground current updated on Page 1.
- Equation values on Page 12 updated.

MIC5255

NOTES:

PRODUCT IDENTIFICATION SYSTEM

To order or obtain information, e.g., on pricing or delivery, contact your local Microchip representative or sales office.

PART NO.	-	XX	X	XX	-	XX
Device		Voltage	Temperature	Package		Media Type
Device:	MIC5255:	150 mA Low Noise μ Cap CMOS LDO				
Voltage: (Note 1, Note 2, Note 3)		2.5 = 2.5V				
		2.8 = 2.8V				
		3.0 = 3.0V				
		3.2 = 3.2V				
		3.3 = 3.3V				
Temperature:	Y =	-40°C to +125°C				
Package:	M5 =	5-Pin SOT-23				
	D5 =	5-Pin TSOT-23				
	ML =	6-Pin 2 mm x 2 mm VDFN				
Media Type: (Note 4)	TR =	3,000/Reel (5,000/Reel if ML package option)				
	TX =	3,000/Reel with Reverse Pin 1 Orientation				
Note 1:	Other voltage options available. Contact Microchip for details.					
Note 2:	The 5-Pin TSOT package (D5) is not available in the 3.2V option.					
Note 3:	The 6-Pin VDFN package (ML) is not available in 2.5V and 3.2V options.					
Note 4:	The TX media type is not available with the ML package option.					
Examples:						
a)	MIC5255-2.5YM5-TR:	150 mA Low Noise μ Cap CMOS LDO, 2.5V Output Voltage, -40°C to +125°C Temp. Range, 5-Pin SOT-23, 3,000/Reel				
b)	MIC5255-2.5YD5-TX:	150 mA Low Noise μ Cap CMOS LDO, 2.5V Output Voltage, -40°C to +125°C Temp. Range, 5-Pin TSOT-23, 3,000/Reel with Reverse Pin 1 Orientation				
c)	MIC5255-2.8YML-TR:	150 mA Low Noise μ Cap CMOS LDO, 2.8V Output Voltage, -40°C to +125°C Temp. Range, 6-Pin VDFN, 5,000/Reel				
d)	MIC5255-3.0YD5-TX:	150 mA Low Noise μ Cap CMOS LDO, 3.0V Output Voltage, -40°C to +125°C Temp. Range, 5-Pin TSOT-23, 3,000/Reel with Reverse Pin 1 Orientation				
e)	MIC5255-3.2YM5-TR:	150 mA Low Noise μ Cap CMOS LDO, 3.2V Output Voltage, -40°C to +125°C Temp. Range, 5-Pin SOT-23, 3,000/Reel				
f)	MIC5255-3.3YML-TR:	150 mA Low Noise μ Cap CMOS LDO, 3.3V Output Voltage, -40°C to +125°C Temp. Range, 6-Pin VDFN, 5,000/Reel				
Note 1:	Tape and Reel identifier only appears in the catalog part number description. This identifier is used for ordering purposes and is not printed on the device package. Check with your Microchip Sales Office for package availability with the Tape and Reel option.					

MIC5255

NOTES:

Note the following details of the code protection feature on Microchip devices:

- Microchip products meet the specification contained in their particular Microchip Data Sheet.
- Microchip believes that its family of products is one of the most secure families of its kind on the market today, when used in the intended manner and under normal conditions.
- There are dishonest and possibly illegal methods used to breach the code protection feature. All of these methods, to our knowledge, require using the Microchip products in a manner outside the operating specifications contained in Microchip's Data Sheets. Most likely, the person doing so is engaged in theft of intellectual property.
- Microchip is willing to work with the customer who is concerned about the integrity of their code.
- Neither Microchip nor any other semiconductor manufacturer can guarantee the security of their code. Code protection does not mean that we are guaranteeing the product as “unbreakable.”

Code protection is constantly evolving. We at Microchip are committed to continuously improving the code protection features of our products. Attempts to break Microchip's code protection feature may be a violation of the Digital Millennium Copyright Act. If such acts allow unauthorized access to your software or other copyrighted work, you may have a right to sue for relief under that Act.

Information contained in this publication regarding device applications and the like is provided only for your convenience and may be superseded by updates. It is your responsibility to ensure that your application meets with your specifications. MICROCHIP MAKES NO REPRESENTATIONS OR WARRANTIES OF ANY KIND WHETHER EXPRESS OR IMPLIED, WRITTEN OR ORAL, STATUTORY OR OTHERWISE, RELATED TO THE INFORMATION, INCLUDING BUT NOT LIMITED TO ITS CONDITION, QUALITY, PERFORMANCE, MERCHANTABILITY OR FITNESS FOR PURPOSE. Microchip disclaims all liability arising from this information and its use. Use of Microchip devices in life support and/or safety applications is entirely at the buyer's risk, and the buyer agrees to defend, indemnify and hold harmless Microchip from any and all damages, claims, suits, or expenses resulting from such use. No licenses are conveyed, implicitly or otherwise, under any Microchip intellectual property rights unless otherwise stated.

Microchip received ISO/TS-16949:2009 certification for its worldwide headquarters, design and wafer fabrication facilities in Chandler and Tempe, Arizona; Gresham, Oregon and design centers in California and India. The Company's quality system processes and procedures are for its PIC® MCUs and dsPIC® DSCs, KEELoC® code hopping devices, Serial EEPROMs, microperipherals, nonvolatile memory and analog products. In addition, Microchip's quality system for the design and manufacture of development systems is ISO 9001:2000 certified.

**QUALITY MANAGEMENT SYSTEM
CERTIFIED BY DNV
= ISO/TS 16949 =**

Trademarks

The Microchip name and logo, the Microchip logo, AnyRate, dsPIC, FlashFlex, flexPWR, Heldo, JukeBlox, KeeLoq, KeeLoq logo, Klear, LANCheck, LINK MD, MediaLB, MOST, MOST logo, MPLAB, OptoLyzer, PIC, PICSTART, PIC32 logo, RightTouch, SpyNIC, SST, SST Logo, SuperFlash and UNI/O are registered trademarks of Microchip Technology Incorporated in the U.S.A. and other countries.

ClockWorks, The Embedded Control Solutions Company, ETHERSYNCH, Hyper Speed Control, HyperLight Load, IntelliMOS, mTouch, Precision Edge, and QUIET-WIRE are registered trademarks of Microchip Technology Incorporated in the U.S.A.

Analog-for-the-Digital Age, Any Capacitor, AnyIn, AnyOut, BodyCom, chipKIT, chipKIT logo, CodeGuard, dsPICDEM, dsPICDEM.net, Dynamic Average Matching, DAM, ECAN, EtherGREEN, In-Circuit Serial Programming, ICSP, Inter-Chip Connectivity, JitterBlocker, KlearNet, KlearNet logo, MiWi, motorBench, MPASM, MPF, MPLAB Certified logo, MPLIB, MPLINK, MultiTRAK, NetDetach, Omniscient Code Generation, PICDEM, PICDEM.net, PICkit, PICtail, PureSilicon, RightTouch logo, REAL ICE, Ripple Blocker, Serial Quad I/O, SQL, SuperSwitcher, SuperSwitcher II, Total Endurance, TSHARC, USBCheck, VariSense, ViewSpan, WiperLock, Wireless DNA, and ZENA are trademarks of Microchip Technology Incorporated in the U.S.A. and other countries.

SQTP is a service mark of Microchip Technology Incorporated in the U.S.A.

Silicon Storage Technology is a registered trademark of Microchip Technology Inc. in other countries.

GestIC is a registered trademarks of Microchip Technology Germany II GmbH & Co. KG, a subsidiary of Microchip Technology Inc., in other countries.

All other trademarks mentioned herein are property of their respective companies.

© 2016, Microchip Technology Incorporated, Printed in the U.S.A., All Rights Reserved.

ISBN: 978-1-5224-1071-3



MICROCHIP

Worldwide Sales and Service

AMERICAS

Corporate Office
2355 West Chandler Blvd.
Chandler, AZ 85224-6199
Tel: 480-792-7200
Fax: 480-792-7277
Technical Support:
<http://www.microchip.com/support>
Web Address:
www.microchip.com

Atlanta
Duluth, GA
Tel: 678-957-9614
Fax: 678-957-1455

Austin, TX
Tel: 512-257-3370

Boston
Westborough, MA
Tel: 774-760-0087
Fax: 774-760-0088

Chicago
Itasca, IL
Tel: 630-285-0071
Fax: 630-285-0075

Dallas
Addison, TX
Tel: 972-818-7423
Fax: 972-818-2924

Detroit
Novi, MI
Tel: 248-848-4000

Houston, TX
Tel: 281-894-5983

Indianapolis
Noblesville, IN
Tel: 317-773-8323
Fax: 317-773-5453
Tel: 317-536-2380

Los Angeles
Mission Viejo, CA
Tel: 949-462-9523
Fax: 949-462-9608
Tel: 951-273-7800

Raleigh, NC
Tel: 919-844-7510

New York, NY
Tel: 631-435-6000

San Jose, CA
Tel: 408-735-9110
Tel: 408-436-4270

Canada - Toronto
Tel: 905-695-1980
Fax: 905-695-2078

ASIA/PACIFIC

Asia Pacific Office
Suites 3707-14, 37th Floor
Tower 6, The Gateway
Harbour City, Kowloon

Hong Kong
Tel: 852-2943-5100
Fax: 852-2401-3431

Australia - Sydney
Tel: 61-2-9868-6733
Fax: 61-2-9868-6755

China - Beijing
Tel: 86-10-8569-7000
Fax: 86-10-8528-2104

China - Chengdu
Tel: 86-28-8665-5511
Fax: 86-28-8665-7889

China - Chongqing
Tel: 86-23-8980-9588
Fax: 86-23-8980-9500

China - Dongguan
Tel: 86-769-8702-9880

China - Guangzhou
Tel: 86-20-8755-8029

China - Hangzhou
Tel: 86-571-8792-8115
Fax: 86-571-8792-8116

China - Hong Kong SAR
Tel: 852-2943-5100
Fax: 852-2401-3431

China - Nanjing
Tel: 86-25-8473-2460
Fax: 86-25-8473-2470

China - Qingdao
Tel: 86-532-8502-7355
Fax: 86-532-8502-7205

China - Shanghai
Tel: 86-21-3326-8000
Fax: 86-21-3326-8021

China - Shenyang
Tel: 86-24-2334-2829
Fax: 86-24-2334-2393

China - Shenzhen
Tel: 86-755-8864-2200
Fax: 86-755-8203-1760

China - Wuhan
Tel: 86-27-5980-5300
Fax: 86-27-5980-5118

China - Xian
Tel: 86-29-8833-7252
Fax: 86-29-8833-7256

ASIA/PACIFIC

China - Xiamen
Tel: 86-592-2388138
Fax: 86-592-2388130

China - Zhuhai
Tel: 86-756-3210040
Fax: 86-756-3210049

India - Bangalore
Tel: 91-80-3090-4444
Fax: 91-80-3090-4123

India - New Delhi
Tel: 91-11-4160-8631
Fax: 91-11-4160-8632

India - Pune
Tel: 91-20-3019-1500

Japan - Osaka
Tel: 81-6-6152-7160
Fax: 81-6-6152-9310

Japan - Tokyo
Tel: 81-3-6880-3770
Fax: 81-3-6880-3771

Korea - Daegu
Tel: 82-53-744-4301
Fax: 82-53-744-4302

Korea - Seoul
Tel: 82-2-554-7200
Fax: 82-2-558-5932 or
82-2-558-5934

Malaysia - Kuala Lumpur
Tel: 60-3-6201-9857
Fax: 60-3-6201-9859

Malaysia - Penang
Tel: 60-4-227-8870
Fax: 60-4-227-4068

Philippines - Manila
Tel: 63-2-634-9065
Fax: 63-2-634-9069

Singapore
Tel: 65-6334-8870
Fax: 65-6334-8850

Taiwan - Hsin Chu
Tel: 886-3-5778-366
Fax: 886-3-5770-955

Taiwan - Kaohsiung
Tel: 886-7-213-7830

Taiwan - Taipei
Tel: 886-2-2508-8600
Fax: 886-2-2508-0102

Thailand - Bangkok
Tel: 66-2-694-1351
Fax: 66-2-694-1350

EUROPE

Austria - Wels
Tel: 43-7242-2244-39
Fax: 43-7242-2244-393

Denmark - Copenhagen
Tel: 45-4450-2828
Fax: 45-4485-2829

Finland - Espoo
Tel: 358-9-4520-820

France - Paris
Tel: 33-1-69-53-63-20
Fax: 33-1-69-30-90-79

France - Saint Cloud
Tel: 33-1-30-60-70-00

Germany - Garching
Tel: 49-8931-9700

Germany - Haan
Tel: 49-2129-3766400

Germany - Heilbronn
Tel: 49-7131-67-3636

Germany - Karlsruhe
Tel: 49-721-625370

Germany - Munich
Tel: 49-89-627-144-0
Fax: 49-89-627-144-44

Germany - Rosenheim
Tel: 49-8031-354-560

Israel - Ra'anana
Tel: 972-9-744-7705

Italy - Milan
Tel: 39-0331-742611
Fax: 39-0331-466781

Italy - Padova
Tel: 39-049-7625286

Netherlands - Drunen
Tel: 31-416-690399
Fax: 31-416-690340

Norway - Trondheim
Tel: 47-7289-7561

Poland - Warsaw
Tel: 48-22-3325737

Romania - Bucharest
Tel: 40-21-407-87-50

Spain - Madrid
Tel: 34-91-708-08-90
Fax: 34-91-708-08-91

Sweden - Gothenberg
Tel: 46-31-704-60-40

Sweden - Stockholm
Tel: 46-8-5090-4654

UK - Wokingham
Tel: 44-118-921-5800
Fax: 44-118-921-5820