

## Dual 100 mA Low-Dropout Regulator

### Features

- High Output Voltage Accuracy
- Variety of Output Voltages
- Up to 100 mA of Continuous Output Current
- Low Ground Current
- Low Dropout Voltage
- Excellent Line and Load Regulations
- Extremely Low Temperature Coefficient
- Current and Thermal Limit Protections
- Reverse-Battery Protection
- Zero-Off Mode Current
- Logic-Controlled Electronic Shutdown
- 8-Pin SOIC Package

### Applications

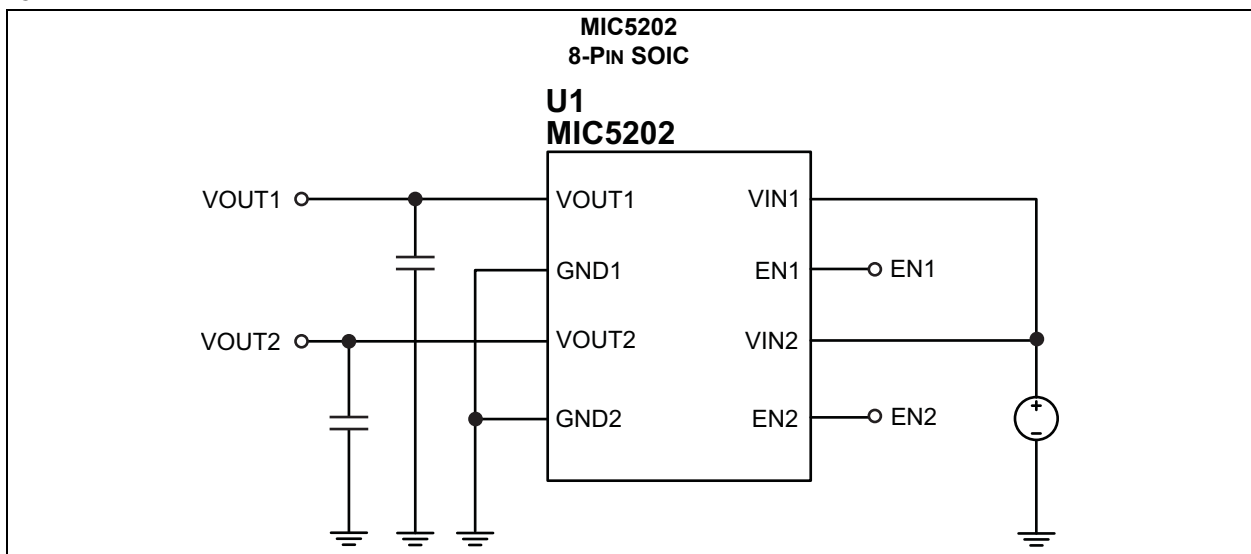
- Cell Phones
- Laptop, Notebook, and Palmtop Computers
- Battery-Powered Equipment
- PCMCIA  $V_{CC}$  and  $V_{PP}$  Regulation/Switching
- Barcode Scanners
- SMPS Post-Regulator/DC-to-DC Modules
- High-Efficiency Linear Power Supplies

### General Description

The MIC5202 is a dual linear voltage regulator with low dropout voltage (typically 17 mV at light loads and 210 mV at 100 mA), and low ground current (1 mA at 100 mA per output). Ideal for battery-operated applications, the MIC5202 offers 1% output voltage accuracy and dual enable pins. The enable pins may be driven individually or tied directly to  $V_{IN}$ . When the part is disabled, power consumption drops to nearly zero. The MIC5202 ground current increases slightly in dropout, which minimizes power consumption and increases battery life. Some key features include reversed battery protection, current-limit, and overtemperature protection.

The MIC5202 is available in fixed output voltages in the small 8-pin SOIC package.

### Typical Application Schematic



# MIC5202

---

## 1.0 ELECTRICAL CHARACTERISTICS

### Absolute Maximum Ratings †

Input Supply Voltage ( $V_{IN1}$ , $V_{IN2}$ ) .....	-20V to +60V
Enable Input Voltage (EN1, EN2) .....	-20V to +60V
ESD Rating (Note 1) .....	ESD Sensitive

### Operating Ratings ‡

Input Supply Voltage ( $V_{IN1}$ , $V_{IN2}$ ) .....	+2.5V to +26V
Enable Input Voltage (EN1, EN2) .....	0V to $V_{IN}$

† **Notice:** Stresses above those listed under “Absolute Maximum Ratings” may cause permanent damage to the device. This is a stress rating only and functional operation of the device at those or any other conditions above those indicated in the operational sections of this specification is not intended. Exposure to maximum rating conditions for extended periods may affect device reliability.

‡ **Notice:** The device is not guaranteed to function outside its operating ratings.

**Note 1:** Devices are ESD sensitive. Handling precautions recommended. Human body model, 1.5 k $\Omega$  in series with 100 pF.

**TABLE 1-1: ELECTRICAL CHARACTERISTICS**

**Electrical Characteristics:**  $V_{IN} = V_{OUT} + 1V$ ,  $C_{OUT} = 10 \mu F$ ;  $I_{OUT} = 1 \text{ mA}$ ;  $T_J = 25^\circ C$ , **bold** values indicate  $-40^\circ C \leq T_J \leq +125^\circ C$ ; unless noted. Specifications are for one LDO. (**Note 1**).

Parameters	Sym.	Min.	Typ.	Max.	Units	Conditions
Output Voltage Accuracy	$V_{OUT}$	-1 <b>-2</b>	—	1 <b>2</b>	%	—
Output Voltage Temperature Coefficient ( <b>Note 2</b> )	$\Delta V_{OUT}/\Delta T$	—	40	<b>150</b>	ppm/ $^\circ C$	—
Line Regulation	$\Delta V_{OUT}/V_{OUT}$	—	0.004	0.10 <b>0.40</b>	%	$V_{IN} = V_{OUT} + 1V$ to 26V
Load Regulation ( <b>Note 3</b> )	$\Delta V_{OUT}/V_{OUT}$	—	0.04	0.16 <b>0.30</b>	%	$I_{OUT} = 0.1 \text{ mA}$ to 100 mA
Dropout Voltage ( <b>Note 4</b> )	$V_{IN} - V_{OUT}$	—	17	—	mV	$I_{OUT} = 100 \mu A$
		—	130	—		$I_{OUT} = 20 \text{ mA}$
		—	150	—		$I_{OUT} = 30 \text{ mA}$
		—	180	—		$I_{OUT} = 50 \text{ mA}$
		—	225	<b>350</b>		$I_{OUT} = 100 \text{ mA}$
Ground Pin Current Shutdown	$I_{SHUT-DOWN}$	—	0.01	—	$\mu A$	$V_{EN} \leq 0.7V$ (shutdown)
Ground Pin Current ( <b>Note 5</b> )	$I_{GND}$	—	170	—	$\mu A$	$V_{EN} \geq 2.0V$ , $I_{OUT} = 100 \mu A$
		—	270	—		$I_{OUT} = 20 \text{ mA}$
		—	330	—		$I_{OUT} = 30 \text{ mA}$
		—	500	—		$I_{OUT} = 50 \text{ mA}$
		—	1200	<b>1500</b>		$I_{OUT} = 100 \text{ mA}$
Ground Pin Current in Dropout	$I_{GNDDO}$	—	270	<b>330</b>	$\mu A$	$V_{IN} = 0.5V$ less than $V_{OUT}$ , $I_{OUT} = 100 \mu A$
Power Supply Rejection Ratio	PSRR	—	75	—	dB	—
Short Circuit Current Limit	$I_{LIMIT}$	—	280	—	mA	$V_{OUT} = 0V$
Thermal Regulation ( <b>Note 6</b> )	$\Delta V_{OUT}/\Delta P_D$	—	0.05	—	%/W	—
Output Noise	$e_n$	—	100	—	$\mu V$	—

**Note 1:** Specification for packaged product only.

**2:** Output voltage temperature coefficient is defined as the worst case voltage change divided by the temperature range.

**3:** Load regulation is measured at a constant junction temperature using low duty cycle pulse testing. Parts are tested for load regulation in the load range from 0.1 mA to 100 mA. Changes in output voltage caused by heating effects are covered by the thermal regulation specification.

**4:** Dropout voltage is defined as the input to output differential at which the output voltage drops 2% below its nominal value measured at 1V differential.

**5:** Ground pin current is the regulator quiescent current plus pass transistor base current. The total current drawn from the supply is the sum of the load current plus the ground pin current.

**6:** Thermal regulation is defined as the change in output voltage at a time “t” after a change in power dissipation is applied, excluding load or line regulation effects. Specifications are for a 100 mA load pulse at  $V_{IN} = 26V$  for  $t = 10 \text{ ms}$ .

# MIC5202

**TABLE 1-1: ELECTRICAL CHARACTERISTICS (CONTINUED)**

<b>Electrical Characteristics:</b> $V_{IN} = V_{OUT} + 1V$ , $C_{OUT} = 10 \mu F$ ; $I_{OUT} = 1 \text{ mA}$ ; $T_J = 25^\circ\text{C}$ , <b>bold</b> values indicate $-40^\circ\text{C} \leq T_J \leq +125^\circ\text{C}$ ; unless noted. Specifications are for one LDO. ( <b>Note 1</b> ).						
Parameters	Sym.	Min.	Typ.	Max.	Units	Conditions
<b>Enable Input</b>						
Enable Input Voltage	$V_{EN}$	—	—	0.7	V	Logic-Low = Off
		2.0	—	—		Logic-High = On
Enable Input Current	$I_{ENL}$	—	0.01	—	$\mu\text{A}$	$V_{EN} \leq 0.7V$
	$I_{ENH}$	—	8	<b>50</b>		$V_{EN} \geq 2.0V$

- Note 1:** Specification for packaged product only.
- 2:** Output voltage temperature coefficient is defined as the worst case voltage change divided by the temperature range.
  - 3:** Load regulation is measured at a constant junction temperature using low duty cycle pulse testing. Parts are tested for load regulation in the load range from 0.1 mA to 100 mA. Changes in output voltage caused by heating effects are covered by the thermal regulation specification.
  - 4:** Dropout voltage is defined as the input to output differential at which the output voltage drops 2% below its nominal value measured at 1V differential.
  - 5:** Ground pin current is the regulator quiescent current plus pass transistor base current. The total current drawn from the supply is the sum of the load current plus the ground pin current.
  - 6:** Thermal regulation is defined as the change in output voltage at a time “t” after a change in power dissipation is applied, excluding load or line regulation effects. Specifications are for a 100 mA load pulse at  $V_{IN} = 26V$  for  $t = 10 \text{ ms}$ .

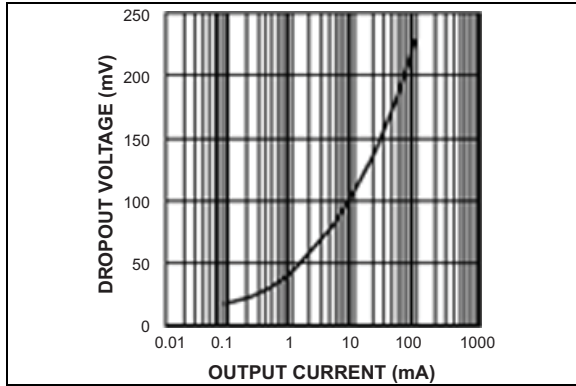
## TEMPERATURE SPECIFICATIONS

Parameters	Sym.	Min.	Typ.	Max.	Units	Conditions
<b>Temperature Ranges</b>						
Junction Operating Temperature Range	$T_J$	-40	—	+125	°C	Note 1
Storage Temperature	$T_S$	-65	—	+150	°C	—
Lead Temperature	—	—	—	+260	°C	Soldering, 10s
<b>Package Thermal Resistances</b>						
Thermal Resistance, SOIC 8-Ld	$\theta_{JA}$	—	63	—	°C/W	—

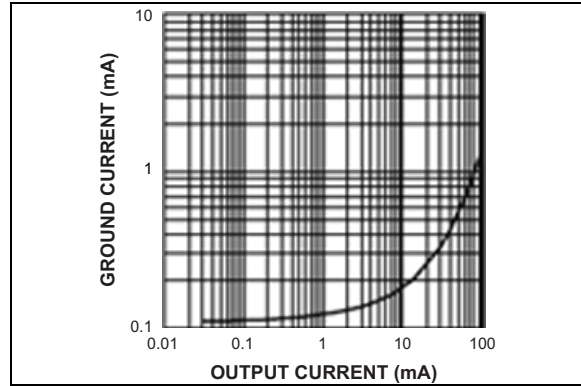
**Note 1:** The maximum allowable power dissipation is a function of ambient temperature, the maximum allowable junction temperature and the thermal resistance from junction to air (i.e.,  $T_A$ ,  $T_J$ ,  $\theta_{JA}$ ). Exceeding the maximum allowable power dissipation will cause the device operating junction temperature to exceed the maximum +125°C rating. Sustained junction temperatures above +125°C can impact the device reliability.

## 2.0 TYPICAL PERFORMANCE CURVES

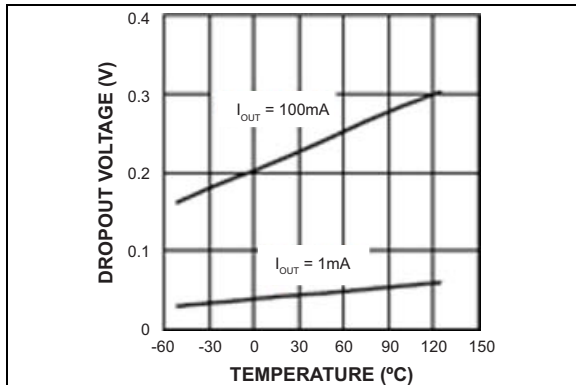
**Note:** The graphs and tables provided following this note are a statistical summary based on a limited number of samples and are provided for informational purposes only. The performance characteristics listed herein are not tested or guaranteed. In some graphs or tables, the data presented may be outside the specified operating range (e.g., outside specified power supply range) and therefore outside the warranted range.



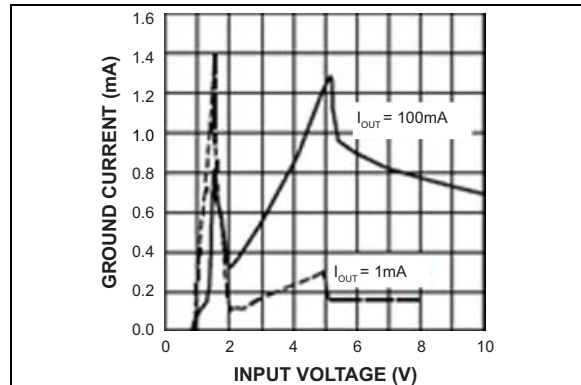
**FIGURE 2-1:** Dropout Voltage vs. Output Current.



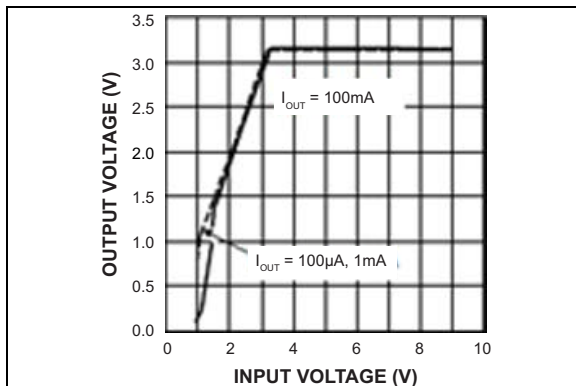
**FIGURE 2-4:** Ground Current vs. Output Current.



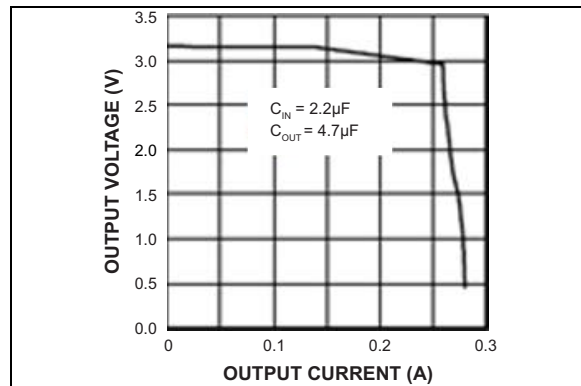
**FIGURE 2-2:** Dropout Voltage vs. Temperature.



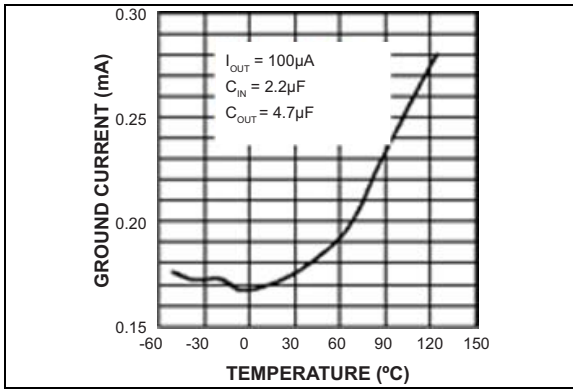
**FIGURE 2-5:** Ground Current vs. Input Voltage.



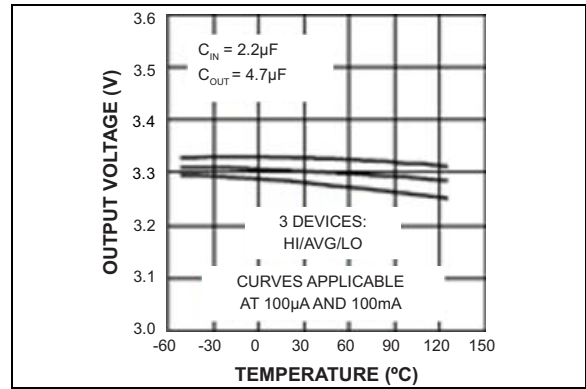
**FIGURE 2-3:** Dropout Characteristics.



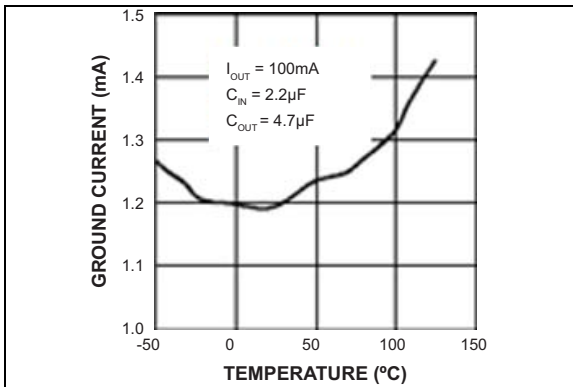
**FIGURE 2-6:** Output Voltage vs. Output Current.



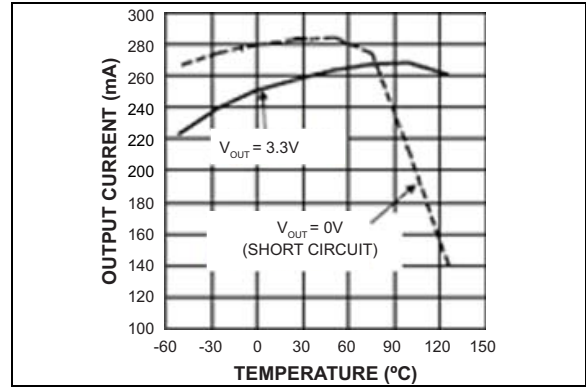
**FIGURE 2-7:** Ground Current vs. Temperature.



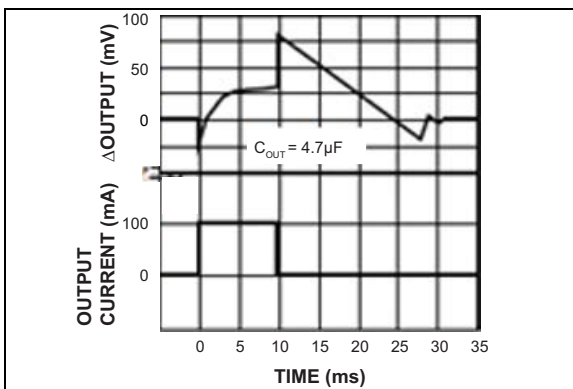
**FIGURE 2-10:** Output Voltage vs. Temperature (3.3V Version).



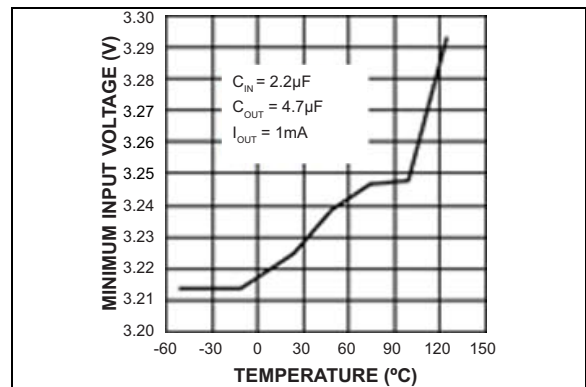
**FIGURE 2-8:** Ground Current vs. Temperature.



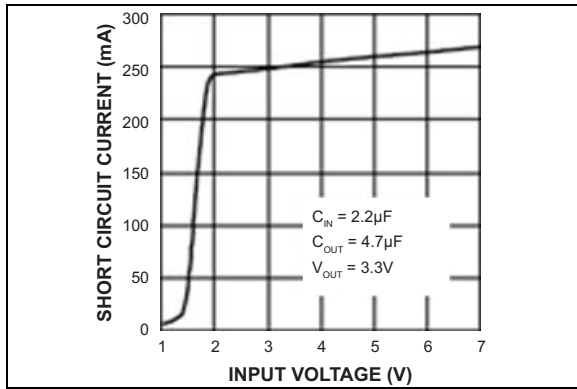
**FIGURE 2-11:** Output Current vs. Temperature.



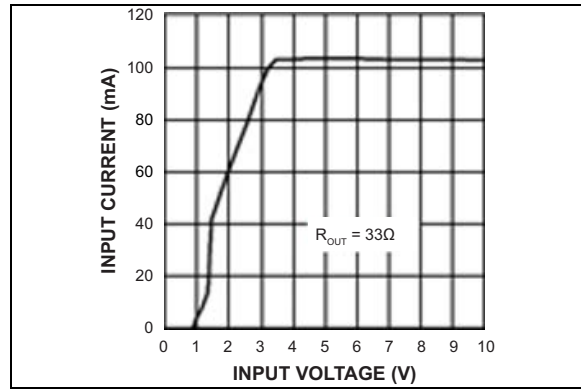
**FIGURE 2-9:** Thermal Regulation (3.3V Version).



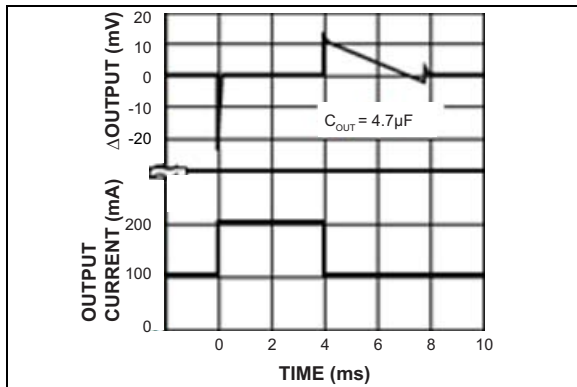
**FIGURE 2-12:** Minimum Input Voltage vs. Temperature.



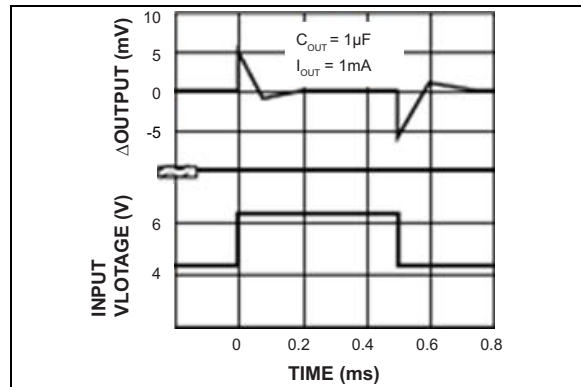
**FIGURE 2-13:** Short Circuit Current vs. Input Voltage.



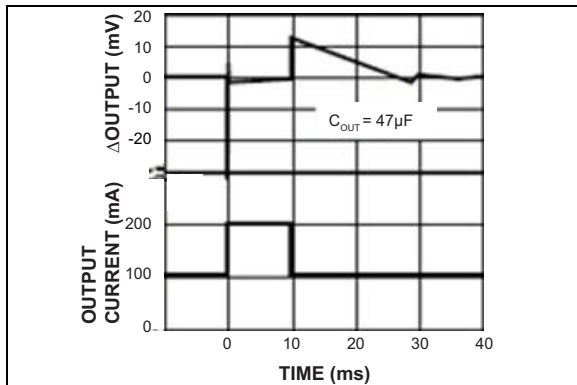
**FIGURE 2-16:** Input Current vs. Input Voltage (3.3V Version).



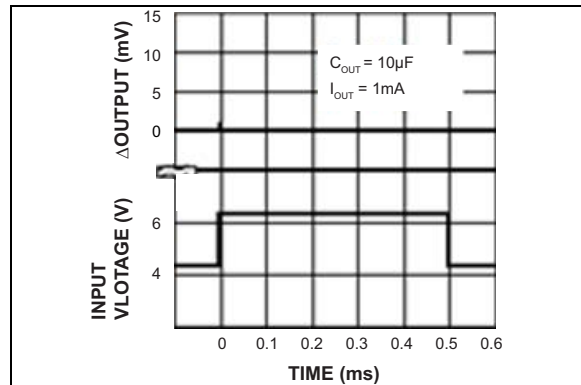
**FIGURE 2-14:** Load Transient.



**FIGURE 2-17:** Line Transient.

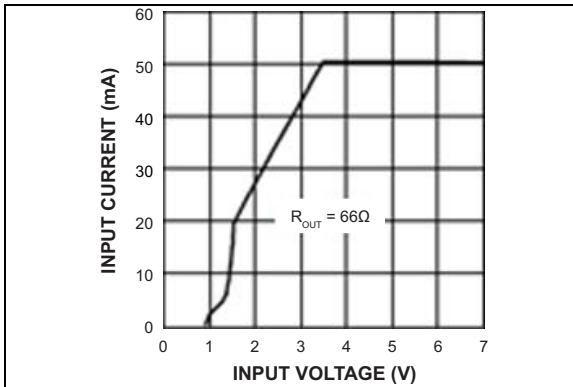


**FIGURE 2-15:** Load Transient.

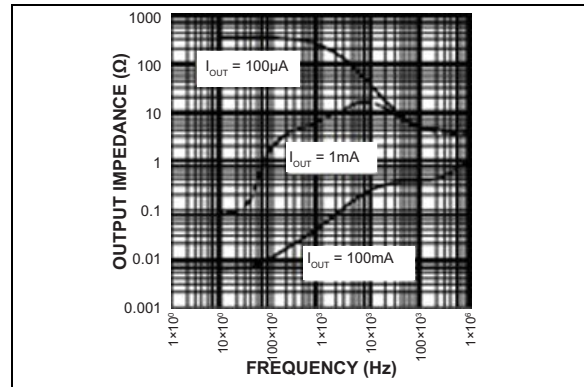


**FIGURE 2-18:** Line Transient.

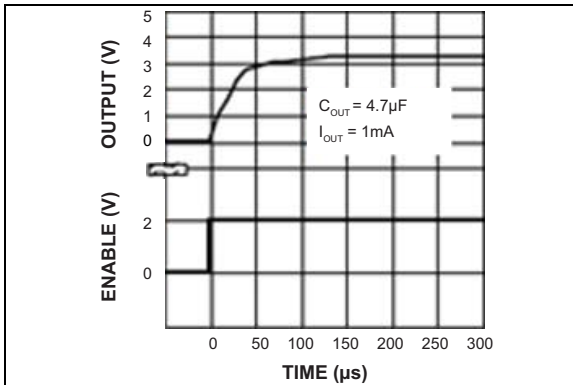




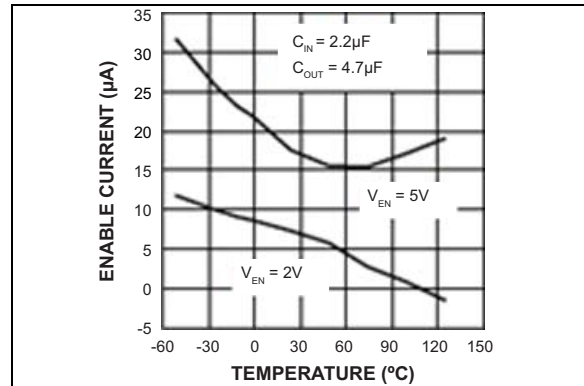
**FIGURE 2-19:** Input Current vs. Input Voltage (3.3V Version).



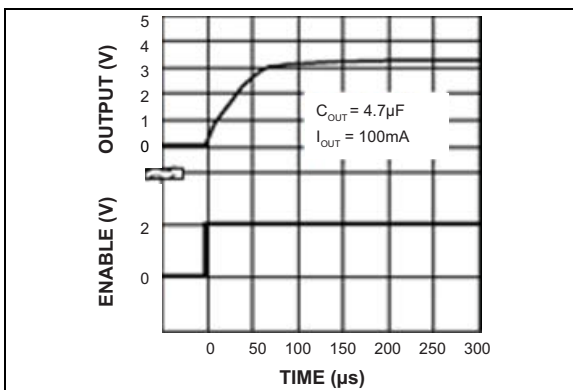
**FIGURE 2-22:** Output Impedance.



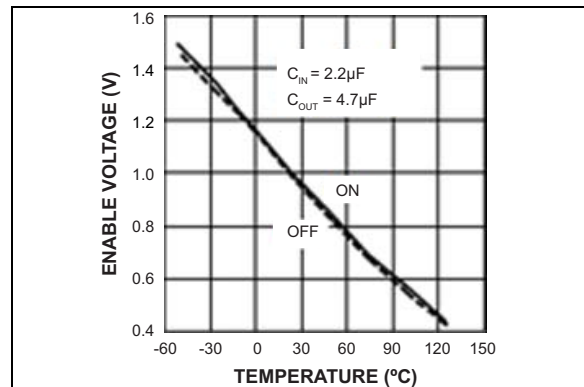
**FIGURE 2-20:** Enable Transient (3.3V Version).



**FIGURE 2-23:** Enable Current Threshold vs. Temperature.

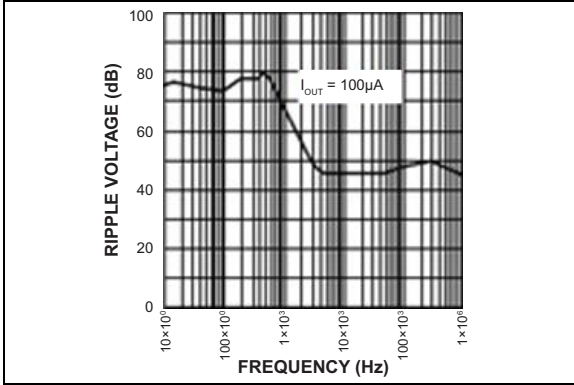


**FIGURE 2-21:** Enable Transient (3.3V Version).

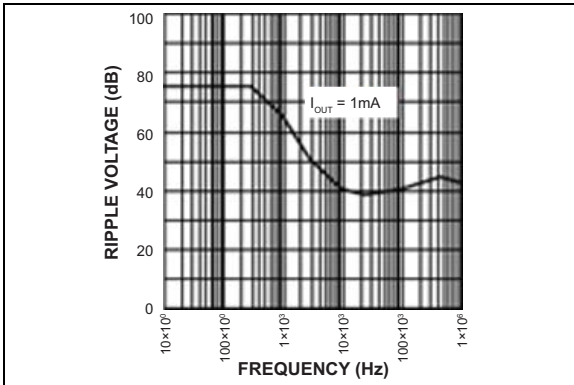


**FIGURE 2-24:** Enable Voltage Threshold vs. Temperature.

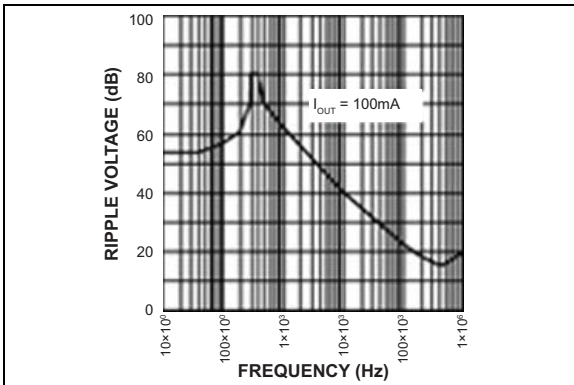
# MIC5202



**FIGURE 2-25:** *Ripple vs. Frequency.*



**FIGURE 2-26:** *Ripple vs. Frequency.*

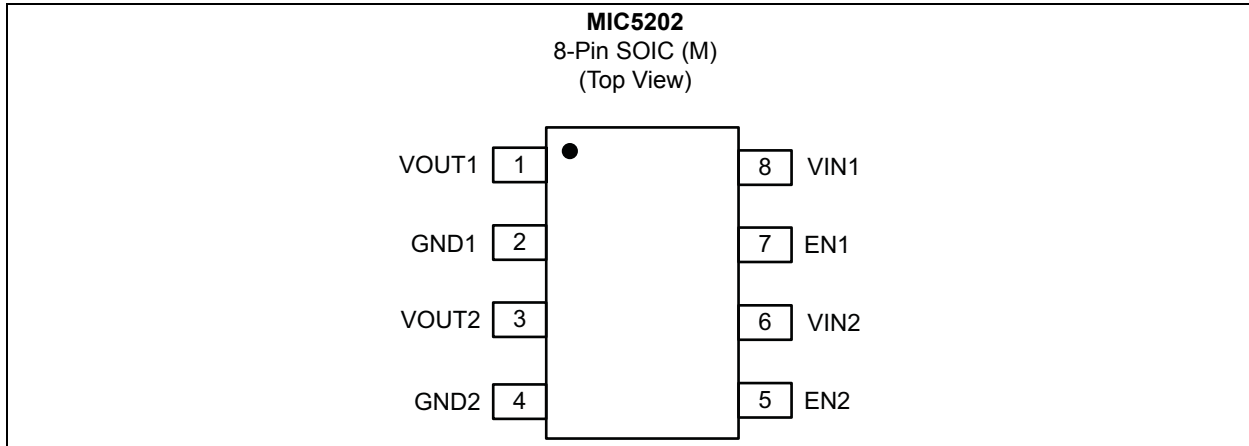


**FIGURE 2-27:** *Ripple vs. Frequency.*

## 3.0 PIN DESCRIPTIONS

The descriptions of the pins are listed in [Table 3-1](#).

### Package Type



**TABLE 3-1: PIN FUNCTION TABLE**

Pin Number	Pin Name	Description
1	V <sub>OUT1</sub>	Output of regulator 1.
2	GND1	Ground pin of LDO1.
3	V <sub>OUT2</sub>	Output of regulator 2.
4	GND2	Ground pin of LDO2.
5	EN2	Enable input for LDO2. Active-high Input. Logic-high = On, logic-low = Off. Do not leave floating.
6	V <sub>IN2</sub>	Voltage input for LDO2.
7	EN1	Enable input for LDO1. Active-high Input. Logic-high = On, logic-low = Off. Do not leave floating.
8	V <sub>IN1</sub>	Voltage input for LDO1.

# MIC5202

---

## 4.0 APPLICATION INFORMATION

The MIC5202 is a dual linear voltage regulator with low dropout voltage and low ground current features. Ideal for battery-operated applications, the MIC5202 offers 1% output voltage accuracy, two independent enable pins, reversed battery protection, short circuit current limit and overtemperature protection. When the MIC5202 is disabled, the ground pin current drops to sub-micro amp and prolongs the battery life.

### 4.1 Input Supply Voltage

$V_{IN1}$  and  $V_{IN2}$  provide power to each internal circuit and may be tied together.

### 4.2 Ground

Both ground pins (pin 2 and 4) must be tied to the same ground potential when using a single power supply.

### 4.3 Input Capacitor

A 1  $\mu$ F tantalum or aluminum electrolytic capacitor should be placed close to each  $V_{IN}$  pin if there is more than 10 inches of copper between the input and the capacitor, or if a battery is used as the supply.

### 4.4 Output Capacitor

The MIC5202 requires an output capacitor of 1  $\mu$ F or greater to maintain stability. Increasing the output capacitor leads to an improved transient response; however, the size and cost also increase. Most tantalum and aluminum electrolytic capacitors are adequate; film capacitors will work as well, but at a higher cost. Many aluminum electrolytics have electrolytes that freeze at  $-30^{\circ}\text{C}$ , so tantalum capacitors are recommended for operations below  $-25^{\circ}\text{C}$ . An equivalent series resistance (ESR) of 5  $\Omega$  or less with a resonance frequency above 500 kHz is recommended. The output capacitor value may be increased without limit.

At lower output loads, a smaller output capacitor value is required for output stability. The capacitor can be reduced to 0.47  $\mu$ F for current below 10 mA or 0.33  $\mu$ F for current below 1 mA.

### 4.5 No-Load Stability

Unlike many other voltage regulators, the MIC5202 remains stable and in regulation with no load. This is especially important in CMOS RAM keep-alive applications.

### 4.6 Enable Input

The MIC5202 features dual active-high enable pins that allow each regulator to be enabled and disabled independently. Forcing the enable pin low disables the

regulator and sends it to a “zero” off-mode-current state. In this state, current consumed by the regulator goes nearly to zero. Forcing the enable pin high enables the output voltage. The active-high enable pin typically consumes 8  $\mu$ A of current and cannot be left floating; a floating enable pin may cause an indeterminate state on the output.

### 4.7 Thermal Shutdown

When the internal die temperature of MIC5202 reaches the limit, the internal driver is disabled until the die temperature falls.

## 5.0 THERMAL CONSIDERATIONS

### 5.1 Layout

The MIC5202 (8-pin SOIC package) has the thermal characteristics shown in [Table 5-1](#), when mounted on a single-layer copper-clad printed circuit board.

**TABLE 5-1: THERMAL CHARACTERISTIC CONSIDERATIONS**

PC Board Dielectric	$\theta_{JA}$
FR4	160°C/W
Ceramic	120°C/W

Multi-layer boards with a dedicated ground plane, wide traces, and large supply bus lines provide better thermal conductivity.

The “worst case” value of 160°C/W assumes no ground plane, minimum trace widths, and a FR4 material board.

### 5.2 Nominal Power Dissipation and Die Temperature

At +25°C ambient temperature, the MIC5202 operates reliably at up to 625 mW when mounted in the “worst case” manner described in the previous section. At an ambient temperature of +55°C, the device can safely dissipate 440 mW. These power levels are equivalent to a die temperature of +125°C, which corresponds to the recommended maximum temperature for non-military grade silicon integrated circuits.

# MIC5202

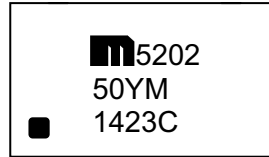
---

## 6.0 PACKAGING INFORMATION

### 6.1 Package Marking Information

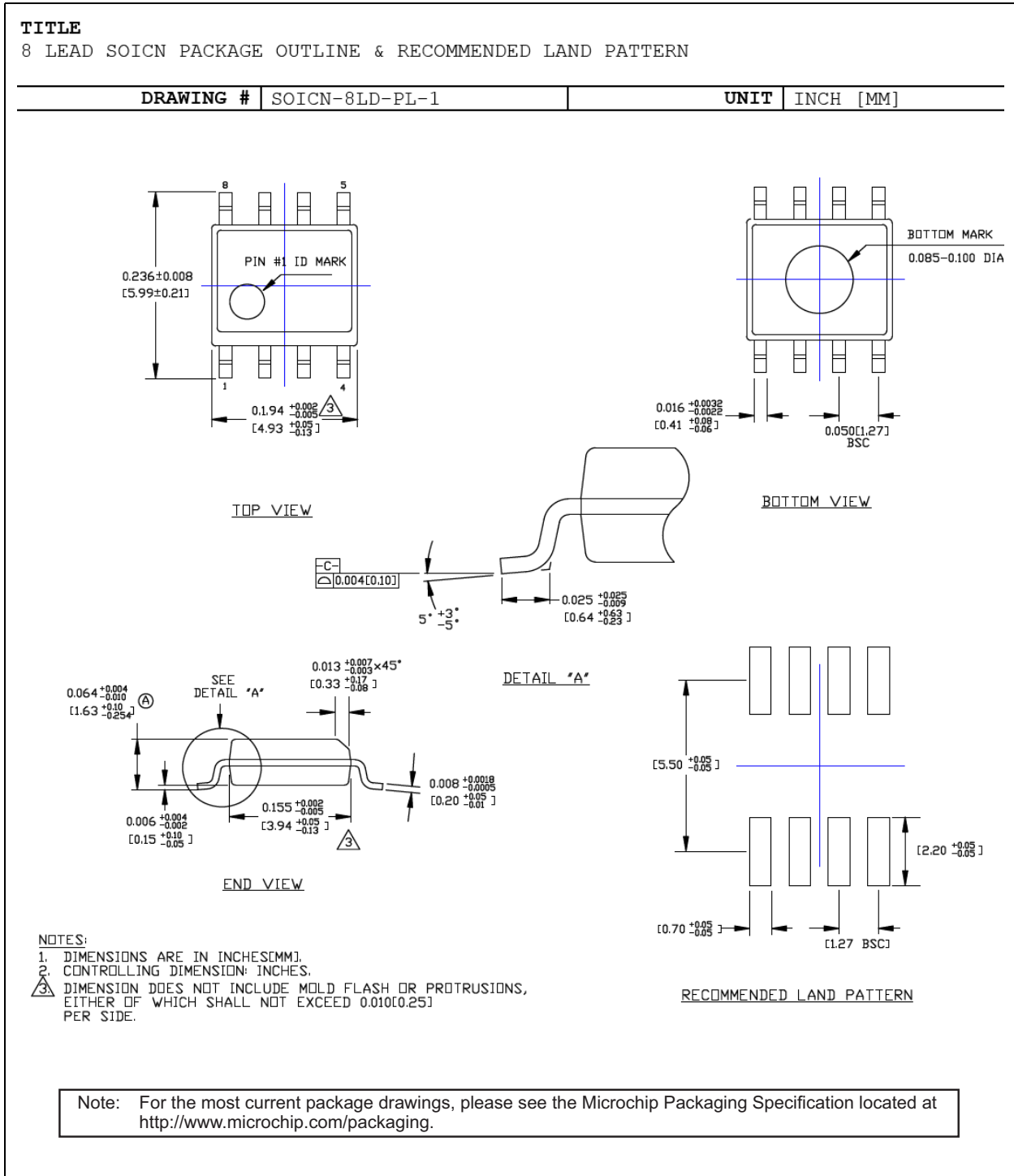
8-Pin SOIC\*

Example



<b>Legend:</b>	XX...X	Product code or customer-specific information
	Y	Year code (last digit of calendar year)
	YY	Year code (last 2 digits of calendar year)
	WW	Week code (week of January 1 is week '01')
	NNN	Alphanumeric traceability code
	(e3)	Pb-free JEDEC® designator for Matte Tin (Sn)
	*	This package is Pb-free. The Pb-free JEDEC designator ((e3)) can be found on the outer packaging for this package.
	•, ▲, ▼	Pin one index is identified by a dot, delta up, or delta down (triangle mark).
<b>Note:</b>	In the event the full Microchip part number cannot be marked on one line, it will be carried over to the next line, thus limiting the number of available characters for customer-specific information. Package may or may not include the corporate logo.	
	Underbar ( _ ) symbol may not be to scale.	

## 8-Pin SOIC Package Outline and Recommended Land Pattern



# MIC5202

---

NOTES:



## APPENDIX A: REVISION HISTORY

### Revision A (August 2016)

- Converted Micrel document MIC5202 to Microchip data sheet DS20005614A.
- Minor text changes throughout.

# MIC5202

---

NOTES:

## PRODUCT IDENTIFICATION SYSTEM

To order or obtain information, e.g., on pricing or delivery, contact your local Microchip representative or sales office.

PART NO.		-	XX	X	XX	-	XX
Device			Output Voltage	Temperature	Package		Media Type
<b>Device:</b>	MIC5202:		Dual 100 mA Low-Dropout Regulator				
<b>Output Voltage:</b>	3.0	=	3.0V				
	3.3	=	3.3V				
	4.8	=	4.85V				
	5.0	=	5.0V				
<b>Temperature:</b>	Y	=	-40°C to +125°C				
<b>Package:</b>	M	=	8-Pin SOIC				
<b>Media Type:</b>	TR	=	2,500/Reel				
	blank	=	95/Tube				

Examples:	
a) MIC5202-3.0YM:	Dual 100 mA Low-Dropout Regulator, 3.0V Voltage, -40°C to +125°C Temp. Range, 8-Pin SOIC, 95/Tube
b) MIC5202-3.0YM-TR:	Dual 100 mA Low-Dropout Regulator, 3.0V Voltage, -40°C to +125°C Temp. Range, 8-Pin SOIC, 2,500/Reel
c) MIC5202-3.3YM:	Dual 100 mA Low-Dropout Regulator, 3.3V Voltage, -40°C to +125°C Temp. Range, 8-Pin SOIC, 95/Tube
d) MIC5202-3.3YM-TR:	Dual 100 mA Low-Dropout Regulator, 3.3V Voltage, -40°C to +125°C Temp. Range, 8-Pin SOIC, 2,500/Reel
e) MIC5202-4.8YM:	Dual 100 mA Low-Dropout Regulator, 4.85V Voltage, -40°C to +125°C Temp. Range, 8-Pin SOIC, 95/Tube
f) MIC5202-4.8YM-TR:	Dual 100 mA Low-Dropout Regulator, 4.85V Voltage, -40°C to +125°C Temp. Range, 8-Pin SOIC, 2,500/Reel
g) MIC5202-5.0YM:	Dual 100 mA Low-Dropout Regulator, 5.0V Voltage, -40°C to +125°C Temp. Range, 8-Pin SOIC, 95/Tube
h) MIC5202-5.0YM-TR:	Dual 100 mA Low-Dropout Regulator, 5.0V Voltage, -40°C to +125°C Temp. Range, 8-Pin SOIC, 2,500/Reel

# MIC5202

---

NOTES:

---

---

**Note the following details of the code protection feature on Microchip devices:**

- Microchip products meet the specification contained in their particular Microchip Data Sheet.
- Microchip believes that its family of products is one of the most secure families of its kind on the market today, when used in the intended manner and under normal conditions.
- There are dishonest and possibly illegal methods used to breach the code protection feature. All of these methods, to our knowledge, require using the Microchip products in a manner outside the operating specifications contained in Microchip's Data Sheets. Most likely, the person doing so is engaged in theft of intellectual property.
- Microchip is willing to work with the customer who is concerned about the integrity of their code.
- Neither Microchip nor any other semiconductor manufacturer can guarantee the security of their code. Code protection does not mean that we are guaranteeing the product as “unbreakable.”

Code protection is constantly evolving. We at Microchip are committed to continuously improving the code protection features of our products. Attempts to break Microchip's code protection feature may be a violation of the Digital Millennium Copyright Act. If such acts allow unauthorized access to your software or other copyrighted work, you may have a right to sue for relief under that Act.

---

Information contained in this publication regarding device applications and the like is provided only for your convenience and may be superseded by updates. It is your responsibility to ensure that your application meets with your specifications. MICROCHIP MAKES NO REPRESENTATIONS OR WARRANTIES OF ANY KIND WHETHER EXPRESS OR IMPLIED, WRITTEN OR ORAL, STATUTORY OR OTHERWISE, RELATED TO THE INFORMATION, INCLUDING BUT NOT LIMITED TO ITS CONDITION, QUALITY, PERFORMANCE, MERCHANTABILITY OR FITNESS FOR PURPOSE. Microchip disclaims all liability arising from this information and its use. Use of Microchip devices in life support and/or safety applications is entirely at the buyer's risk, and the buyer agrees to defend, indemnify and hold harmless Microchip from any and all damages, claims, suits, or expenses resulting from such use. No licenses are conveyed, implicitly or otherwise, under any Microchip intellectual property rights unless otherwise stated.

*Microchip received ISO/TS-16949:2009 certification for its worldwide headquarters, design and wafer fabrication facilities in Chandler and Tempe, Arizona; Gresham, Oregon and design centers in California and India. The Company's quality system processes and procedures are for its PIC® MCUs and dsPIC® DSCs, KEELoc® code hopping devices, Serial EEPROMs, microperipherals, nonvolatile memory and analog products. In addition, Microchip's quality system for the design and manufacture of development systems is ISO 9001:2000 certified.*

**QUALITY MANAGEMENT SYSTEM  
CERTIFIED BY DNV  
= ISO/TS 16949 =**

### Trademarks

The Microchip name and logo, the Microchip logo, AnyRate, dsPIC, FlashFlex, flexPWR, Heldo, JukeBlox, KeeLoq, KeeLoq logo, Klear, LANCheck, LINK MD, MediaLB, MOST, MOST logo, MPLAB, OptoLyzer, PIC, PICSTART, PIC32 logo, RightTouch, SpyNIC, SST, SST Logo, SuperFlash and UNI/O are registered trademarks of Microchip Technology Incorporated in the U.S.A. and other countries.

ClockWorks, The Embedded Control Solutions Company, ETHERSYNCH, Hyper Speed Control, HyperLight Load, IntelliMOS, mTouch, Precision Edge, and QUIET-WIRE are registered trademarks of Microchip Technology Incorporated in the U.S.A.

Analog-for-the-Digital Age, Any Capacitor, AnyIn, AnyOut, BodyCom, chipKIT, chipKIT logo, CodeGuard, dsPICDEM, dsPICDEM.net, Dynamic Average Matching, DAM, ECAN, EtherGREEN, In-Circuit Serial Programming, ICSP, Inter-Chip Connectivity, JitterBlocker, KlearNet, KlearNet logo, MiWi, motorBench, MPASM, MPF, MPLAB Certified logo, MPLIB, MPLINK, MultiTRAK, NetDetach, Omniscient Code Generation, PICDEM, PICDEM.net, PICkit, PICtail, PureSilicon, RightTouch logo, REAL ICE, Ripple Blocker, Serial Quad I/O, SQL, SuperSwitcher, SuperSwitcher II, Total Endurance, TSHARC, USBCheck, VariSense, ViewSpan, WiperLock, Wireless DNA, and ZENA are trademarks of Microchip Technology Incorporated in the U.S.A. and other countries.

SQTP is a service mark of Microchip Technology Incorporated in the U.S.A.

Silicon Storage Technology is a registered trademark of Microchip Technology Inc. in other countries.

GestIC is a registered trademarks of Microchip Technology Germany II GmbH & Co. KG, a subsidiary of Microchip Technology Inc., in other countries.

All other trademarks mentioned herein are property of their respective companies.

© 2016, Microchip Technology Incorporated, Printed in the U.S.A., All Rights Reserved.

ISBN: 978-1-5224-0891-8



# MICROCHIP

## Worldwide Sales and Service

### AMERICAS

#### Corporate Office

2355 West Chandler Blvd.  
Chandler, AZ 85224-6199

Tel: 480-792-7200

Fax: 480-792-7277

Technical Support:

[http://www.microchip.com/  
support](http://www.microchip.com/support)

Web Address:

[www.microchip.com](http://www.microchip.com)

#### Atlanta

Duluth, GA

Tel: 678-957-9614

Fax: 678-957-1455

#### Austin, TX

Tel: 512-257-3370

#### Boston

Westborough, MA

Tel: 774-760-0087

Fax: 774-760-0088

#### Chicago

Itasca, IL

Tel: 630-285-0071

Fax: 630-285-0075

#### Cleveland

Independence, OH

Tel: 216-447-0464

Fax: 216-447-0643

#### Dallas

Addison, TX

Tel: 972-818-7423

Fax: 972-818-2924

#### Detroit

Novi, MI

Tel: 248-848-4000

#### Houston, TX

Tel: 281-894-5983

#### Indianapolis

Noblesville, IN

Tel: 317-773-8323

Fax: 317-773-5453

#### Los Angeles

Mission Viejo, CA

Tel: 949-462-9523

Fax: 949-462-9608

#### New York, NY

Tel: 631-435-6000

#### San Jose, CA

Tel: 408-735-9110

#### Canada - Toronto

Tel: 905-695-1980

Fax: 905-695-2078

### ASIA/PACIFIC

#### Asia Pacific Office

Suites 3707-14, 37th Floor  
Tower 6, The Gateway  
Harbour City, Kowloon

#### Hong Kong

Tel: 852-2943-5100

Fax: 852-2401-3431

#### Australia - Sydney

Tel: 61-2-9868-6733

Fax: 61-2-9868-6755

#### China - Beijing

Tel: 86-10-8569-7000

Fax: 86-10-8528-2104

#### China - Chengdu

Tel: 86-28-8665-5511

Fax: 86-28-8665-7889

#### China - Chongqing

Tel: 86-23-8980-9588

Fax: 86-23-8980-9500

#### China - Dongguan

Tel: 86-769-8702-9880

#### China - Guangzhou

Tel: 86-20-8755-8029

#### China - Hangzhou

Tel: 86-571-8792-8115

Fax: 86-571-8792-8116

#### China - Hong Kong SAR

Tel: 852-2943-5100

Fax: 852-2401-3431

#### China - Nanjing

Tel: 86-25-8473-2460

Fax: 86-25-8473-2470

#### China - Qingdao

Tel: 86-532-8502-7355

Fax: 86-532-8502-7205

#### China - Shanghai

Tel: 86-21-5407-5533

Fax: 86-21-5407-5066

#### China - Shenyang

Tel: 86-24-2334-2829

Fax: 86-24-2334-2393

#### China - Shenzhen

Tel: 86-755-8864-2200

Fax: 86-755-8203-1760

#### China - Wuhan

Tel: 86-27-5980-5300

Fax: 86-27-5980-5118

#### China - Xian

Tel: 86-29-8833-7252

Fax: 86-29-8833-7256

### ASIA/PACIFIC

#### China - Xiamen

Tel: 86-592-2388138

Fax: 86-592-2388130

#### China - Zhuhai

Tel: 86-756-3210040

Fax: 86-756-3210049

#### India - Bangalore

Tel: 91-80-3090-4444

Fax: 91-80-3090-4123

#### India - New Delhi

Tel: 91-11-4160-8631

Fax: 91-11-4160-8632

#### India - Pune

Tel: 91-20-3019-1500

#### Japan - Osaka

Tel: 81-6-6152-7160

Fax: 81-6-6152-9310

#### Japan - Tokyo

Tel: 81-3-6880-3770

Fax: 81-3-6880-3771

#### Korea - Daegu

Tel: 82-53-744-4301

Fax: 82-53-744-4302

#### Korea - Seoul

Tel: 82-2-554-7200

Fax: 82-2-558-5932 or

82-2-558-5934

#### Malaysia - Kuala Lumpur

Tel: 60-3-6201-9857

Fax: 60-3-6201-9859

#### Malaysia - Penang

Tel: 60-4-227-8870

Fax: 60-4-227-4068

#### Philippines - Manila

Tel: 63-2-634-9065

Fax: 63-2-634-9069

#### Singapore

Tel: 65-6334-8870

Fax: 65-6334-8850

#### Taiwan - Hsin Chu

Tel: 886-3-5778-366

Fax: 886-3-5770-955

#### Taiwan - Kaohsiung

Tel: 886-7-213-7828

#### Taiwan - Taipei

Tel: 886-2-2508-8600

Fax: 886-2-2508-0102

#### Thailand - Bangkok

Tel: 66-2-694-1351

Fax: 66-2-694-1350

### EUROPE

#### Austria - Wels

Tel: 43-7242-2244-39

Fax: 43-7242-2244-393

#### Denmark - Copenhagen

Tel: 45-4450-2828

Fax: 45-4485-2829

#### France - Paris

Tel: 33-1-69-53-63-20

Fax: 33-1-69-30-90-79

#### Germany - Dusseldorf

Tel: 49-2129-3766400

#### Germany - Karlsruhe

Tel: 49-721-625370

#### Germany - Munich

Tel: 49-89-627-144-0

Fax: 49-89-627-144-44

#### Italy - Milan

Tel: 39-0331-742611

Fax: 39-0331-466781

#### Italy - Venice

Tel: 39-049-7625286

#### Netherlands - Drunen

Tel: 31-416-690399

Fax: 31-416-690340

#### Poland - Warsaw

Tel: 48-22-3325737

#### Spain - Madrid

Tel: 34-91-708-08-90

Fax: 34-91-708-08-91

#### Sweden - Stockholm

Tel: 46-8-5090-4654

#### UK - Wokingham

Tel: 44-118-921-5800

Fax: 44-118-921-5820

06/23/16