

Multiple Channel Capacitive Touch Sensor and LED Driver

General Description

The CAP1114, which incorporates Microchip's Right-Touch™ technology, is a multiple channel Capacitive Touch sensor and LED Driver.

The CAP1114 contains up to fourteen (14) individual Capacitive Touch sensor inputs with programmable sensitivity for use in touch button and slider switch applications. Each sensor also contains automatic recalibration with programmable time delays.

The CAP1114 also includes internal circuitry to compensate for design and parasitic variance in untouched capacitance on sensors.

The CAP1114 also contains eleven (11) low side LED drivers that offer full-on / off, variable rate blinking, dimness controls, and breathing. Capacitive buttons can be linked to LED outputs.

Applications

- Consumer Electronics
- Desktop and Notebook PCs
- LCD Monitors

Features

- Fourteen (14) capacitive touch sensor inputs
 - Compensates for variable sensor capacitance
 - Programmable sensitivity
 - High SNR allows for easy tuning
 - Automatic recalibration
 - Slider acceleration detection
 - Slider positional detection
 - Proximity detection
- Lid closure detection
- Low power operation
 - 4.5uA quiescent current in Deep Sleep
 - 200uA quiescent current in Sleep while monitoring 1 button
- Alert to signal touch to host processor
- User controlled reset
- Low external component count
- SMBus 2.0 compliant interface to change operating parameters to work in a wide variety of systems
 - Block Read and Write function for quick tasking
- Eleven (11) LED driver outputs
 - Programmable blink, breathe, and dimness controls
 - 8 configurable as GPIOs
 - Buttons can be linked to LED responses
- Development boards and software available

Block Diagram

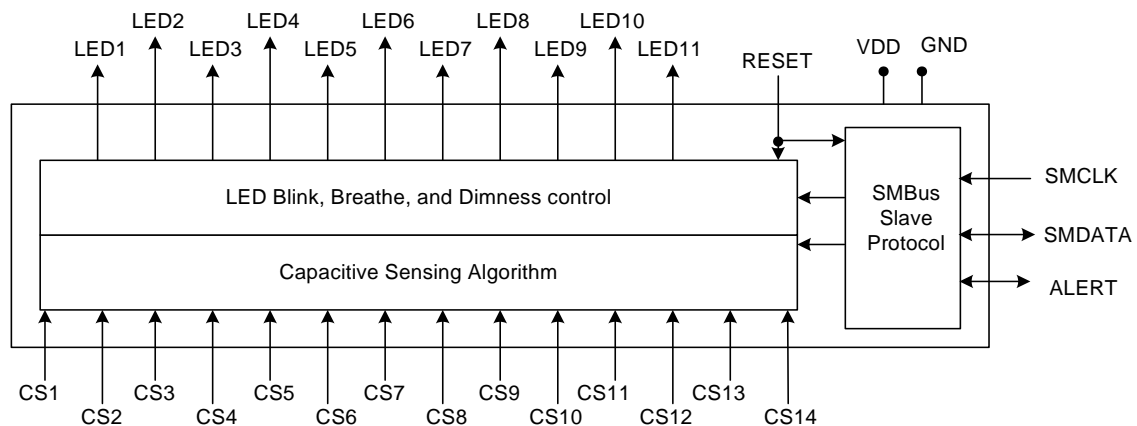

TO OUR VALUED CUSTOMERS

It is our intention to provide our valued customers with the best documentation possible to ensure successful use of your Microchip products. To this end, we will continue to improve our publications to better suit your needs. Our publications will be refined and enhanced as new volumes and updates are introduced.

If you have any questions or comments regarding this publication, please contact the Marketing Communications Department via E-mail at docerrors@microchip.com. We welcome your feedback.

Most Current Data Sheet

To obtain the most up-to-date version of this data sheet, please register at our Worldwide Web site at:

<http://www.microchip.com>

You can determine the version of a data sheet by examining its literature number found on the bottom outside corner of any page. The last character of the literature number is the version number, (e.g., DS30000000A is version A of document DS30000000).

Errata

An errata sheet, describing minor operational differences from the data sheet and recommended workarounds, may exist for current devices. As device/documentation issues become known to us, we will publish an errata sheet. The errata will specify the revision of silicon and revision of document to which it applies.

To determine if an errata sheet exists for a particular device, please check with one of the following:

- Microchip's Worldwide Web site; <http://www.microchip.com>
- Your local Microchip sales office (see last page)

When contacting a sales office, please specify which device, revision of silicon and data sheet (include -literature number) you are using.

Customer Notification System

Register on our web site at www.microchip.com to receive the most current information on all of our products.

Table of Contents

1.0 Delta from CAP1014 to CAP1114	4
2.0 Pin Description	6
3.0 Electrical Specifications	9
4.0 Communications	12
5.0 Product Description	15
6.0 Register Description	26
7.0 Package Information	74
Appendix A: Data Sheet Revision History	77
The Microchip Web Site	79
Customer Change Notification Service	79
Customer Support	79
Product Identification System	80

CAP1114

1.0 DELTA FROM CAP1014 TO CAP1114

1.1 Summary

1. Updated circuitry to reduce sensitivity to power supply stepping.
2. Updated LED Pulse 1 behavior. This function may be triggered on button press or on release. See [Section 6.50](#).
3. Updated Product ID to 3Ah.
4. Updated LED behavior for host control during direct mode when not linked. The LED Output register will now be able to be written to emulate a touch or release. Enables all behaviors while in host mode. See [Section 6.44](#) and [Section 6.48](#).
5. Updated recalibration controls to add negative delta count. See [Section 6.28](#).
6. Removed ACAL_RT bits.
7. Added digital controls to disable the slider functionality but still detect basic touches essentially bypassing the slider algorithms entirely. See [Section 6.34](#).
8. Added controls to enable individual buttons in the slider. See [Section 6.35](#).
9. Updated button interrupt schemes to allow interrupt on press only, not on release. Retained previous behavior as default. See [Figure 5-2](#), [Figure 5-3](#), and [Section 5.7.1](#). Retained previous behavior as default. See [Section 6.28](#).
10. Updated Noise Threshold default settings to ~25%. See [Section 6.30](#).
11. Added control bit and status registers to enable interrupt when LEDs finish their directed behavior in the same fashion. See [Section 6.53](#) and [Section 6.40](#).
12. Updated LED driver duty cycle decode values to have more distribution at lower values - closer to a logarithmic curve. See [Section 6.54](#).
13. Renamed D_DSP[3:0] and C_DSP[3:0] to DELTA_SENSE[2:0] and BASE_SHIFT[3:0]. D_DSP[3] did nothing so removed references. See [Section 6.13](#).
14. Added filtering on RESET pin to prevent errant resets. The RESET pin must be high or low for longer than 10ms before it will be detected by the device. See [Section 8.6](#).
15. Added proximity to CS1 channel.
16. Updated Deep Sleep to wake on communications. See [Section 5-1](#).
17. Updated controls so that the RESET pin assertion places the device into the lowest power state available. See [Section 5.2](#) and [Section 5.1](#).
18. Added LED transition controls that affect the LED behavior when a Capacitive Touch Sensor is linked to an LED channel to remove bouncing. See [Section 6.46](#).
19. Added controls to “mirror” the LED duty cycle outputs so that when polarity changed, the LED brightness levels look right. See [Section 6.47](#).
20. Added register to force digital recalibration of all sensors. See [Section 6.33](#).
21. Added register to enable oversampling on specific sensors. See [Section 6.36](#) and [Section 6.38](#).
22. Changed PWM frequency for LED drivers. The PWM frequency was derived from the programmed breathe period and duty cycle settings and it ranged from ~4Hz to ~8000 Hz. The PWM frequency has been updated to be a fixed value of ~2000Hz.

1.2 Register Delta

TABLE 1-1: REGISTER DELTA

Address	Register Delta	Delta	Default
05h	Changed - Build Revision	Reset build revision to 10h	10h
20h	Changed - Configuration	Changed functionality of RPT_EN_B bit. Changed default	29h
2Fh	Changed - Recalibration Configuration	Removed ACAL_RT[1:0] bits and replaced with NEG_CNT[1:0] bits. These bits control recalibration when negative counts are received.	93h

TABLE 1-1: REGISTER DELTA (CONTINUED)

Address	Register Delta	Delta	Default
38h	Changed - Button Noise Threshold 1	Changed default	AAh
39h	Changed - Button Noise Threshold 2	Changed default	AAh
3Fh	New - Digital Recalibration	New register to force digital recalibration on all sensors	00h
40h	New - Configuration 2	New register to control LED touch linking behavior, LED output behavior, and noise detection, and interrupt on release	00h
41h	New - Grouped Channel Sensor Enable	New register to enable individual sensors within the grouped sensors	7Fh
42h	New - Proximity Control	New register to enable / configure proximity settings on CS1	02h
46h	New - Group Button Calibration Activate	New register to force calibration on individual grouped sensors	00h
4Eh	New - Sampling Channel Select	New register to select which channels can be controlled via the Sampling Configuration register	00h
60h	New - LED Status 1	New register to store status for LEDs that have finished their programmed behavior	00h
61h	New - LED Status 2	New register to store status for LEDs that have finished their programmed behavior	00h
77h	New - Linked LED Transition Control 1	New register to control transition effect when LED linked to CS sensor	00h
78h	New - Linked LED Transition Control 2	New register to control transition effect when LED linked to CS sensor	00h
79h	New - LED Mirror Control 1	New register to control LED output mirroring for brightness control when polarity changed	00h
7Ah	New - LED Mirror Control 2	New register to control LED output mirroring for brightness control when polarity changed	00h
90h	Changed - LED Pulse 1 Duty Cycle	Changed bit decode to be more logarithmic	F0h
91h	Changed - LED Pulse 2 Duty Cycle	Changed bit decode to be more logarithmic	F0h
92h	Changed - LED Breathe Duty Cycle	Changed bit decode to be more logarithmic	F0h
93h	Changed - LED Direct Duty Cycle	Changed bit decode to be more logarithmic	F0h
FDh	Changed - Product ID	Changed bit decode for CAP1114	3Ah
FEh	Added - Manufacturer ID	Added - this register mirrors the Vendor ID	5Dh

CAP1114

2.0 PIN DESCRIPTION

FIGURE 2-1: CAP1114 PIN DIAGRAM (32-PIN QFN)

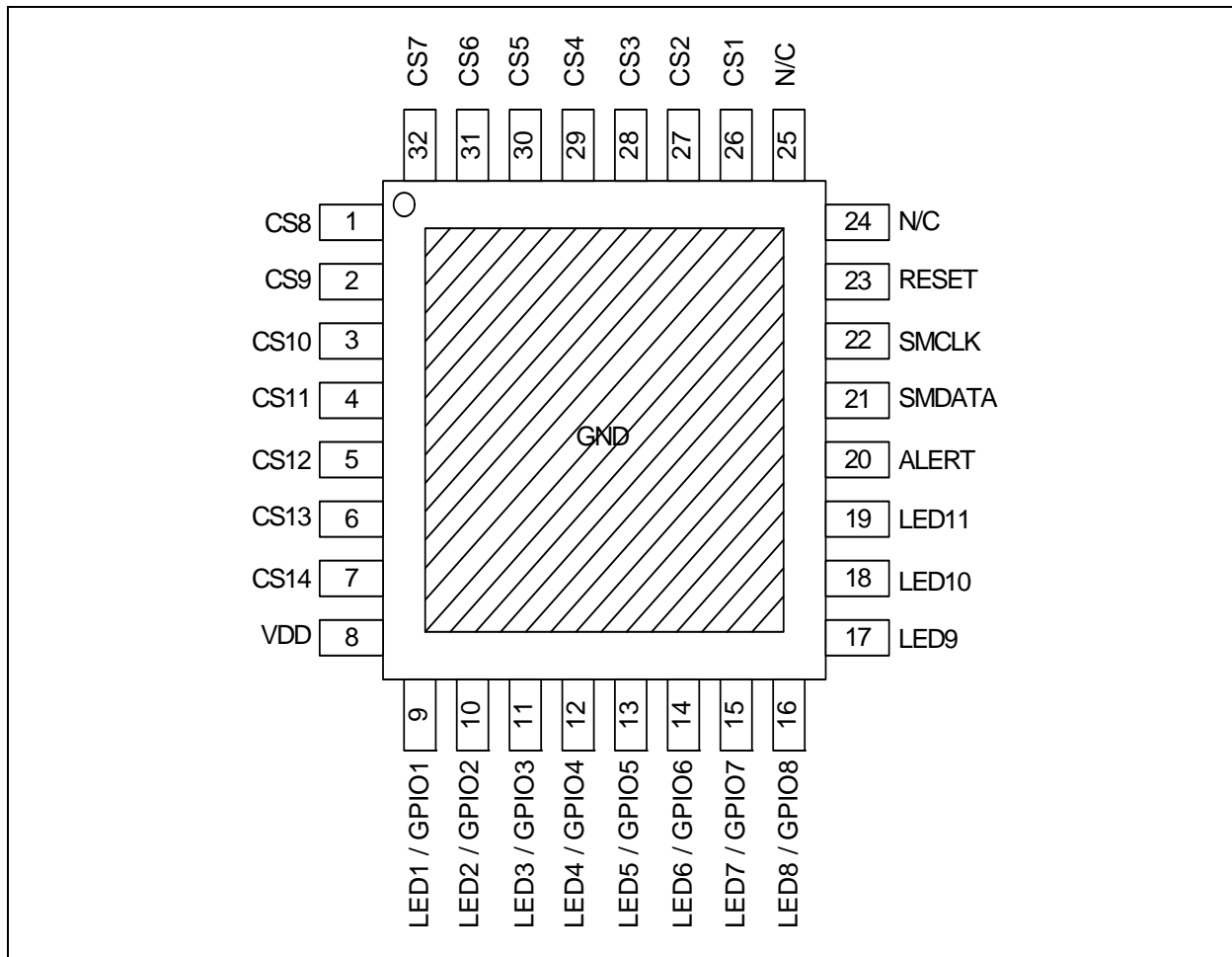

TABLE 2-1: PIN DESCRIPTION FOR CAP1114

Pin Number	Pin Name	Pin Function	Pin Type
1	CS8	Capacitive Touch Sensor 8	AIO
2	CS9	Capacitive Touch Sensor 9	AIO
3	CS10	Capacitive Touch Sensor 10	AIO
4	CS11	Capacitive Touch Sensor 11	AIO
5	CS12	Capacitive Touch Sensor 12	AIO
6	CS13	Capacitive Touch Sensor 13	AIO
7	CS14	Capacitive Touch Sensor 14	AIO
8	VDD	Positive Power supply	Power
9	LED1 / GPIO1	LED1 - Open drain LED driver (default)	OD (5V)
		GPI1 - GPIO 1 Input	DI (5V)
		GPO1 - GPIO 1 push-pull output	DO

TABLE 2-1: PIN DESCRIPTION FOR CAP1114 (CONTINUED)

Pin Number	Pin Name	Pin Function	Pin Type
10	LED2 / GPIO 2	LED2 - Open drain LED driver (default)	OD (5V)
		GPI2 - GPIO 2 Input	DI (5V)
		GPO2 - GPIO 2 push-pull output	DO
11	LED3 / GPIO3	LED3 - Open drain LED driver (default)	OD (5V)
		GPI3 - GPIO 3 Input	DI (5V)
		GPO3 - GPIO 3 push-pull output	DO
12	LED4 / GPIO4	LED4 - Open drain LED driver (default)	OD (5V)
		GPI4 - GPIO 4 Input	DI (5V)
		GPO4 - GPIO 4 push-pull output	DO
13	LED5 / GPIO5	LED5 - Open drain LED driver (default)	OD (5V)
		GPI5 - GPIO 5 Input	DI (5V)
		GPO5 - GPIO 5 push-pull output	DO
14	LED6 / GPIO6	LED6 - Open drain LED driver (default)	OD (5V)
		GPI6 - GPIO 6 Input	DI (5V)
		GPO6 - GPIO 6 push-pull output	DO
15	LED7 / GPIO7	LED7 - Open drain LED driver (default)	OD (5V)
		GPI7 - GPIO 7 Input	DI (5V)
		GPO7 - GPIO 7 push-pull output	DO
16	LED8 / GPIO8	LED8 - Open drain LED driver (default)	OD (5V)
		GPI8 - GPIO 8 Input	DI (5V)
		GPO8 - GPIO 8 push-pull output	DO
17	LED9	LED9 - Open drain LED driver	OD (5V)
18	LED10	LED10 - Open drain LED driver	OD (5V)
19	LED11	LED11 - Open drain LED driver	OD (5V)
20	ALERT	Active High Interrupt / Wake Up Input	DIO
21	SMDATA	Bi-directional SMBus data - requires a pull-up resistor	DIOD (5V)
22	SMCLK	SMBus clock input - requires a pull-up resistor	DI (5V)
23	RESET	Soft reset for system - resets all registers to default values	DI (5V)
24	N/C	Not Connected - connect to gnd	N/A
25	N/C	Not Connected - connect to gnd	N/A
26	CS1	Capacitive Touch Sensor 1	AIO
27	CS2	Capacitive Touch Sensor 2	AIO
28	CS3	Capacitive Touch Sensor 3	AIO
29	CS4	Capacitive Touch Sensor 4	AIO
30	CS5	Capacitive Touch Sensor 5	AIO
31	CS6	Capacitive Touch Sensor 6	AIO
32	CS7	Capacitive Touch Sensor 7	AIO
Bottom Plate	GND	Power Ground	Power

The pin types are described in [Table 2-2, "Pin Types"](#). All pins labeled with (5V) are 5V tolerant.

Note: For all 5V tolerant pins that require a pull-up resistor, the voltage difference between VDD and the pull-up voltage must never exceed 3.6V.

CAP1114

TABLE 2-2: PIN TYPES

Pin Type	Description
Power	This pin is used to supply power or ground to the device.
DI	Digital Input - this pin is used as a digital input. This pin is 5V tolerant.
DIO	Digital Input Output - this pin is used as a digital input / output.
AIO	Analog Input / Output - this pin is used as an I/O for analog signals.
DIOD	Digital Input / Open Drain Output - this pin is used as a digital I/O. When it is used as an output, It is open drain and requires a pull-up resistor. This pin is 5V tolerant.
OD	Open Drain Digital Output - this pin is used as a digital output. It is open drain and requires a pull-up resistor. This pin is 5V tolerant.
DO	Push-pull Digital Output - this pin is used as a digital output and can sink and source current.

3.0 ELECTRICAL SPECIFICATIONS

TABLE 3-1: ABSOLUTE MAXIMUM RATINGS

Voltage on VDD pin	-0.3 to 4	V
Voltage on 5V tolerant pins (V_{5VT_PIN})	-0.3 to 5.5	V
Voltage on 5V tolerant pins ($ V_{5VT_PIN} - V_{DD} $) (see Note 3-1)	0 to 3.6	V
Voltage on any other pin to GND	-0.3 to VDD + 0.3	V
Package Power Dissipation up to $T_A = 85^\circ\text{C}$ (see Note 3-2)	1	W
Junction to Ambient (θ_{JA}) (see Note 3-3)	48	$^\circ\text{C/W}$
Operating Ambient Temperature Range	-40 to 125	$^\circ\text{C}$
Storage Temperature Range	-55 to 150	$^\circ\text{C}$
ESD Rating, All Pins, HBM	8000	V

Note: Stresses above those listed could cause permanent damage to the device. This is a stress rating only and functional operation of the device at any other condition above those indicated in the operation sections of this specification is not implied.

Note 3-1 For the 5V tolerant pins that have a pull-up resistor, the pull-up voltage must not exceed 3.6V when the device is unpowered.

Note 3-2 The Package Power Dissipation specification assumes a thermal via design with the thermal landing be soldered to the PCB ground plane with 0.3mm (12mil) diameter vias in a 4x4 matrix at 0.9mm (35.4mil) pitch.

Note 3-3 Junction to Ambient (θ_{JA}) is dependent on the design of the thermal vias. Without thermal vias and a thermal landing, the θ_{JA} is approximately 60°C/W including localized PCB temperature increase.

TABLE 3-2: ELECTRICAL SPECIFICATIONS

$V_{DD} = 3\text{V to } 3.6\text{V}$, $T_A = -40^\circ\text{C to } 125^\circ\text{C}$, all Typical values at $T_A = 27^\circ\text{C}$ unless otherwise noted.						
Characteristic	Symbol	MIN	TYP	MAX	Unit	Conditions
DC Power						
Supply Voltage	V_{DD}	3.0	3.3	3.6	V	
Supply Current	I_{DD}		0.55	1	mA	Average current Capacitive Sensing Active, LEDs enabled
	I_{SLEEP}		200	250	μA	Sleep state active, 1 sensor monitored; LED11 inactive $T_A < 85^\circ\text{C}$
	I_{DSLEEP}		4.5	10	μA	Deep Sleep, LED 11 inactive $T_A < 40^\circ\text{C}$
Time to Communications	t_{COMM}		15	20	ms	Time from power applied to communications active
Time to First Conversion	t_{CONV}		400	500	ms	Time from power applied to first sensor sampled
Capacitive Touch Sensor						
Base Capacitance	C_{BASE}	5	15	50	pF	Pad untouched
Detectable Capacitive Shift	ΔC_{TOUCH}	0.1	0.4	2	pF	Pad touched
Sample Time	t_{TOUCH}		2.5		ms	
Update Time	Δt_{TOUCH}		35		ms	
Recalibration Interval	Δt_{CAL}		8		s	Automatic Recalibration active, no touch active, default settings

CAP1114

TABLE 3-2: ELECTRICAL SPECIFICATIONS (CONTINUED)

V _{DD} = 3V to 3.6V, T _A = -40°C to 125°C, all Typical values at T _A = 27°C unless otherwise noted.						
Characteristic	Symbol	MIN	TYP	MAX	Unit	Conditions
LED / GPIO Drivers (LED / GPIO 1 - 8)						
Duty Cycle	DUTY _{LED}	0		100	%	Programmable
Drive Frequency	f _{LED}		2		kHz	
Sinking Current	I _{SINK}			24	mA	V _{OL} = 0.4
Sourcing Current	I _{SOURCE}			24	mA	V _{OH} = V _{DD} - 0.4
Input High Voltage	V _{IH}	2.0			V	LED / GPIO configured as input
Input Low Voltage	V _{IL}			0.8	V	LED / GPIO configured as input
LED Drivers (LED 9 - LED 10)						
Duty Cycle	DUTY _{LED}	0		100	%	Programmable
Drive Frequency	f _{LED}		2		kHz	
Sinking Current	I _{SINK}			24	mA	
Output Low Voltage	V _{OL}			0.4	V	I _{SINK} = 24mA
LED11 Driver						
Duty Cycle	DUTY _{LED}	0		100	%	Programmable
Drive Frequency	f _{LED}		2		kHz	
Sinking Current	I _{SINK}			48	mA	
Output Low Voltage	V _{OL}			0.4	V	I _{SINK} = 48mA
I/O Pins - SMDATA, SMCLK, and ALERT Pins						
Output Low Voltage	V _{OL}			0.4	V	I _{SINK_IO} = 8mA
Output High Voltage	V _{OH}	V _{DD} - 0.4			V	ALERT pin active high and asserted I _{SOURCE_IO} = 8mA
Input High Voltage	V _{IH}	2.0			V	
Input Low Voltage	V _{IL}			0.8	V	
Leakage Current	I _{LEAK}			±5	uA	powered or unpowered T _A < 85°C pull-up voltage ≤ 3.6V
RESET Pin						
Input High Voltage	V _{IH}	2.0			V	
Input Low Voltage	V _{IL}			0.8	V	
RESET Filter Time	t _{RST_FILT}	10			ms	
RESET Pin release to fully active operation	t _{RST_ON}		400	500	ms	
SMBus Timing						
Input Capacitance	C _{IN}		5		pF	
Clock Frequency	f _{SMB}	10		400	kHz	
Spike Suppression	t _{SP}			50	ns	
Bus free time Start to Stop	t _{BUF}	1.3			us	
Setup Time: Start	t _{SU:STA}	0.6			us	
Setup Time: Stop	t _{SU:STP}	0.6			us	
Data Hold Time	t _{HD:DAT}	0.6		6	us	
Data Setup Time	t _{SU:DAT}	0.6		72	us	
Clock Low Period	t _{LOW}	1.3			us	
Clock High Period	t _{HIGH}	0.6			us	

TABLE 3-2: ELECTRICAL SPECIFICATIONS (CONTINUED)

V _{DD} = 3V to 3.6V, T _A = -40°C to 125°C, all Typical values at T _A = 27°C unless otherwise noted.						
Characteristic	Symbol	MIN	TYP	MAX	Unit	Conditions
Clock/Data Fall time	t _{FALL}			300	ns	Min = 20+0.1C _{LOAD} ns
Clock/Data Rise time	t _{RISE}			300	ns	Min = 20+0.1C _{LOAD} ns
Capacitive Load	C _{LOAD}			400	pF	per bus line

CAP1114

4.0 COMMUNICATIONS

The CAP1114 communicates via the SMBus or I²C communications protocols.

APPLICATION NOTE: Upon power up, the CAP1114 will not respond to any SMBus communications for 10ms. After this time, full functionality is available.

4.1 System Management Bus Protocol

The CAP1114 communicates with a host controller, such as a Microchip SIO, through the SMBus. The SMBus is a two-wire serial communication protocol between a computer host and its peripheral devices. A detailed timing diagram is shown in Figure 4-1. Stretching of the SMCLK signal is supported; however, the CAP1114 will not stretch the clock signal.

FIGURE 4-1: SMBUS TIMING DIAGRAM

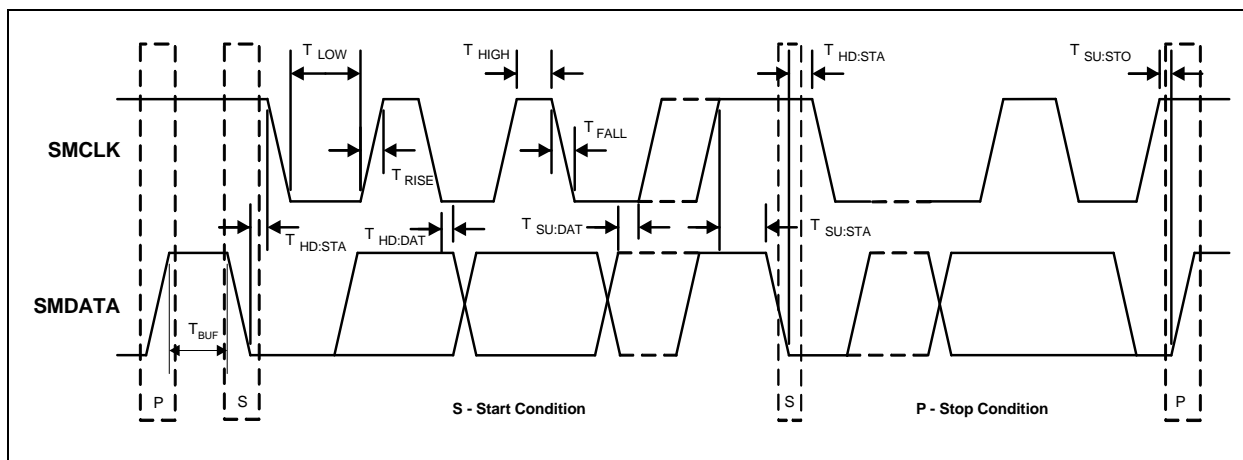

4.1.1 SMBUS START BIT

The SMBus Start bit is defined as a transition of the SMBus Data line from a logic '1' state to a logic '0' state while the SMBus Clock line is in a logic '1' state.

4.1.2 SMBUS ADDRESS AND RD / \overline{WR} BIT

The SMBus Address Byte consists of the 7-bit client address followed by the RD / \overline{WR} indicator bit. If this RD / \overline{WR} bit is a logic '0', the SMBus Host is writing data to the client device. If this RD / \overline{WR} bit is a logic '1', the SMBus Host is reading data from the client device.

The slave addresses of CAP1114 are factory-set. For CAP1114-1, it responds to the slave address 0101_000xb. For CAP1114-2, it responds to the slave address 0101_101xb.

4.1.3 SMBUS DATA BYTES

All SMBus Data bytes are sent most significant bit first and composed of 8-bits of information.

4.1.4 SMBUS ACK AND NACK BITS

The SMBus client will acknowledge all data bytes that it receives. This is done by the client device pulling the SMBus Data line low after the 8th bit of each byte that is transmitted. This applies to both the Write Byte and Block Write protocols.

The Host will NACK (not acknowledge) the last data byte to be received from the client by holding the SMBus data line high after the 8th data bit has been sent. For the Block Read protocol, the Host will ACK each data byte that it receives except the last data byte.

4.1.5 SMBUS STOP BIT

The SMBus Stop bit is defined as a transition of the SMBus Data line from a logic '0' state to a logic '1' state while the SMBus clock line is in a logic '1' state. When the CAP1114 detects an SMBus Stop bit, and it has been communicating with the SMBus protocol, it will reset its client interface and prepare to receive further communications.

4.1.6 SMBUS TIME-OUT

The CAP1114 includes an SMBus time-out feature. Following a 30ms period of inactivity on the SMBus where the SMCLK pin is held low, the device will time-out and reset the SMBus interface.

The time-out function defaults to disabled. It can be enabled by setting the TIMEOUT bit in the Configuration register (see [Section 6.14](#)).

4.1.7 SMBUS AND I²C COMPLIANCE

The major difference between SMBus and I²C devices is highlighted here. For complete compliance information, refer to the SMBus 2.0 specification.

1. Minimum frequency for SMBus communications is 10kHz.
2. The client protocol will reset if the clock is held low longer than 30ms.
3. Except when operating in Deep Sleep, the client protocol will reset if both the clock and the data line are high for longer than 150us (idle condition).
4. I²C devices do not support the Alert Response Address functionality (which is optional for SMBus).

4.2 SMBus Protocols

The CAP1114 is SMBus 2.0 compatible and supports Send Byte, Read Byte, Block Read, Receive Byte as valid protocols as shown below. The CAP1114 also supports the I²C block read and block write protocols.

All of the below protocols use the convention in [Table 4-1](#).

TABLE 4-1: PROTOCOL FORMAT

Data Sent to Device	Data Sent to the Host
Data sent	Data sent

4.2.1 SMBUS WRITE BYTE

The Write Byte is used to write one byte of data to a specific register as shown in [Table 4-2](#).

TABLE 4-2: WRITE BYTE PROTOCOL

Start	Client Address	WR	ACK	Register Address	ACK	Register Data	ACK	Stop
1 -> 0	0101_000	0	0	XXh	0	XXh	0	0 -> 1

4.2.2 BLOCK WRITE

The Block Write is used to write multiple data bytes to a group of contiguous registers as shown in [Table 4-3](#). It is an extension of the Write Byte Protocol.

APPLICATION NOTE: When using the Block Write protocol, the internal address pointer will be automatically incremented after every data byte is received. It will wrap from FFh to 00h.

CAP1114

TABLE 4-3: BLOCK WRITE PROTOCOL

Start	Client Address	WR	ACK	Register Address	ACK	Register Data	ACK
1 -> 0	0101_000	0	0	XXh	0	XXh	0
Register Data	ACK	Register Data	ACK	...	Register Data	ACK	Stop
XXh	0	XXh	0	...	XXh	0	0 -> 1

4.2.3 SMBUS READ BYTE

The Read Byte protocol is used to read one byte of data from the registers as shown in [Table 4-4](#).

TABLE 4-4: READ BYTE PROTOCOL

Start	Client Address	WR	ACK	Register Address	ACK	Start	Client Address	RD	ACK	Register Data	NACK	Stop
1->0	0101_000	0	0	XXh	0	1 -> 0	0101_000	1	0	XXh	1	0 -> 1

4.2.4 BLOCK READ

The Block Read is used to read multiple data bytes from a group of contiguous registers as shown in [Table 4-5](#). It is an extension of the Read Byte Protocol.

APPLICATION NOTE: When using the Block Read protocol, the internal address pointer will be automatically incremented after every data byte is received. It will wrap from FFh to 00h.

TABLE 4-5: BLOCK READ PROTOCOL

Start	Client Address	WR	ACK	Register Address	ACK	Start	Client Address	RD	ACK	Register Data
1->0	0101_000	0	0	XXh	0	1 -> 0	0101_000	1	0	XXh
ACK	REGISTER DATA	ACK	REGISTER DATA	ACK	REGISTER DATA	ACK	...	REGISTER DATA	NACK	STOP
0	XXh	0	XXh	0	XXh	0	...	XXh	1	0 -> 1

4.2.5 SMBUS SEND BYTE

The Send Byte protocol is used to set the internal address register pointer to the correct address location. No data is transferred during the Send Byte protocol as shown in [Table 4-6](#).

TABLE 4-6: SEND BYTE PROTOCOL

Start	Client Address	WR	ACK	Register Address	ACK	Stop
1 -> 0	0101_000	0	0	XXh	0	0 -> 1

4.2.6 SMBUS RECEIVE BYTE

The Receive Byte protocol is used to read data from a register when the internal register address pointer is known to be at the right location (e.g. set via Send Byte). This is used for consecutive reads of the same register as shown in [Table 4-7](#).

TABLE 4-7: RECEIVE BYTE PROTOCOL

Start	Client Address	RD	ACK	Register Data	NACK	Stop
1 -> 0	0101_000	1	0	XXh	1	0 -> 1

5.0 PRODUCT DESCRIPTION

The CAP1114 is a multiple channel Capacitive Touch sensor and LED Driver.

The CAP1114 contains up to 14 individual Capacitive Touch sensor inputs with programmable sensitivity for use in touch button and slider switch applications. Each sensor also contains automatic recalibration.

The CAP1114 also contains eleven (11) open drain LED drivers that offer full-on / off, variable rate breathing, and dimness controls. Eight (8) of these LEDs can double as GPIOs and support open-drain or push-pull operation. Capacitive buttons can be linked to LED outputs. Additionally, LEDs 1-7 may be optionally linked to Buttons 1-7 so that when a touch is detected, the LED is actuated.

The device communicates with a host controller using SMBus. The host controller may poll the device for updated information at any time or it may configure the device to flag an interrupt whenever a press is detected on any sensor.

Each sensor is polled by the device approximately every 35 ms. The host may also initiate a recalibration routine for one or more sensors or set up times and conditions so that the device automatically invokes the re-calibration routine.

The CAP1114 contains multiple power states including several low power operating states. In addition, it contains a user driven RESET pin to force the device to reset.

A typical system diagram is shown in [Figure 5-1](#).

CAP1114

FIGURE 5-1: SYSTEM DIAGRAM FOR CAP1114

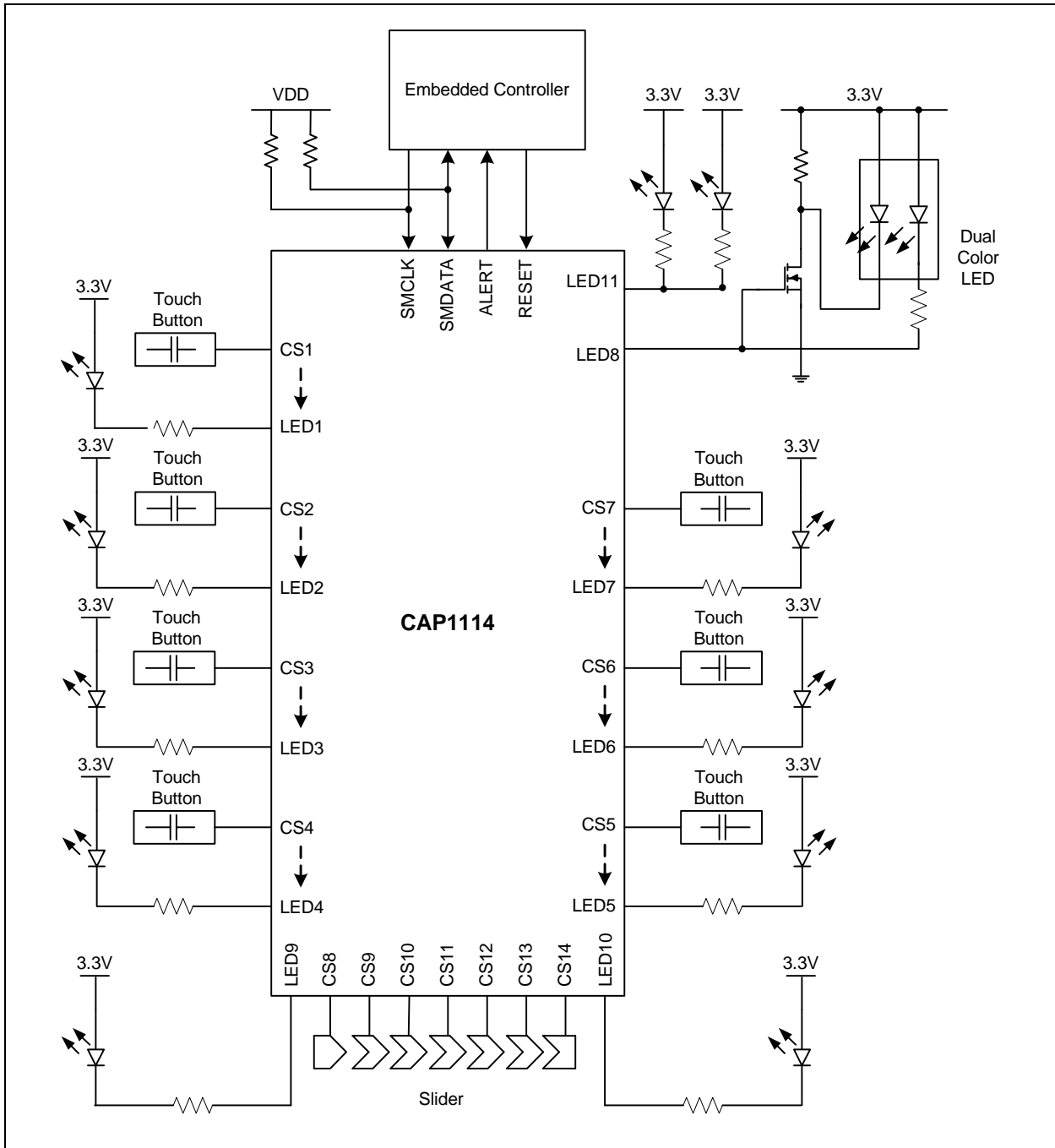

5.1 Power States

The CAP1114 has four operating states depending on the status of the SLEEP, DEACT, and DSLEEP bits (see [Section 6.1](#)). They are described below and summarized in [Table 5-1](#). When the device transitions between power states, previously detected touches (for deactivated channels) are cleared and the status bits reset.

1. Fully Active - The device is fully active. It is monitoring all active Capacitive Sensor channels and driving all LED channels as defined.
2. Sleep - The device is in the Sleep state. It is monitoring a limited number of Capacitive Sensor channels (default

- 2). Interrupts will still be generated based on the active channels. The device will still respond to SMBus commands normally and can be returned to the Fully Active state by clearing the SLEEP bit. The LED11 channel is controlled via the PWR_LED control (see [Section 6.1](#)). All other LEDs will not be affected.
3. Deep Sleep - The device is in Deep Sleep state. It is not monitoring any Capacitive Sensor channels or the SMBus. The LED11 channel is controlled via the PWR_LED control (see [Section 6.1](#)). All other LEDs will be driven to their programmed non-actuated state and no PWM operations will be done.

When the device enters the Deep Sleep state, it will release control to the ALERT pin and will change the direction of the ALERT pin (i.e. the device will monitor the ALERT pin instead of driving it).

The device has two methods to exit the Deep Sleep state. They are:

- a) The ALERT pin is driven to its active state.
- b) Any SMBus communications are directed at the device.

When the device leaves the Deep Sleep state, it automatically returns to its previously defined state and clears the DSLEEP bit.

Note: When the device enters the Deep Sleep state, the Slider Position / Volumetric Data Register (06h) is cleared.

4. Inactive - The device is inactive. It is not monitoring any Capacitive Sensor channels. The device will still respond to SMBus commands normally and can be returned to Fully Active state by clearing the DEACT bit. All LEDs will have PWM controls suspended so they should be disabled prior to entering this state. If these LEDs are not disabled, the system will show excess current draw from these LEDs.

TABLE 5-1: POWER STATES

Power State	DEACT	SLEEP	DSLEEP
Fully Active	0	0	0
Deep Sleep waking to Fully Active	0	0	1
Sleep	0	1	0
Deep Sleep waking to Sleep	0	1	1
Inactive	1	0	0
Deep Sleep waking to Inactive	1	0	1
Inactive	1	1	0
Deep Sleep waking to Inactive	1	1	1

The priority of power control signals is:

1. DSLEEP - when set, will override DEACT, disable all LEDs except LED11 then disable SMBus communications.
2. DEACT - when set, will override the SLEEP controls. It will disable sensor measurement and all LEDs.
3. SLEEP - when set, will enable Sleep state.

5.2 RESET Pin

The RESET pin is an active high reset that is driven from an external source. The pin contains an internal delay timer (t_{RST_FILT}) that will block errant glitches on the RESET pin. The RESET pin must be driven high or low longer than this time before the CAP1114 will react to the pin state.

While the RESET pin is held high, all the internal blocks will be held in reset including the SMBus. All configuration settings will be reset to default states and all readings will be cleared. Furthermore, the device will be held in Deep Sleep that can only be removed by driving the RESET pin low.

Once the RESET pin is pulled low, the CAP1114 will begin operation as if a power-on-reset had occurred. When this happens, the RESET bit will be set and an interrupt will be generated.

5.3 LED Drivers

The CAP1114 contains eleven (11) LED Drivers. Each LED Driver is controlled independently of the others and may be linked to the corresponding Capacitive Touch Sensor input. All LED drivers will operate in one of the following modes. LED drivers 1 - 8 can be configured to operate with either push-pull or open-drain drive and may also be configured to operate as GPIOs. LED drivers 9 - 11 will only operate as open-drain drivers.

1. Direct - The LED is configured to be on or off when the corresponding input stimulus is on or off (or inverted). The brightness of the LED can be programmed from full off to full on (default). Additionally, the LED contains controls to individually configure ramping on, off, and turn-off delay.
2. Pulse 1 - The LED is configured to “Pulse” (transition ON-OFF-ON) a programmable number of times with programmable rate and min / max brightness. Further, the LED can be configured to be actuated upon a touch detection or release detection (or based on user written control registers).
3. Pulse 2 - The LED is configured to “Pulse” while actuated and then “Pulse” a programmable number of times with programmable rate and min / max brightness when the sensor is released.
4. Breathe - The LED is configured to transition continuously ON-OFF-ON (i.e. to “Breathe”) with a programmable rate and min / max brightness.

In addition to these four behaviors, all LED drivers support user initiated ramps and have an option to assert the ALERT pin when the ramp has reached its maximum or minimum settings.

LED11 operates differently than the other LED outputs in three ways. First, it is configured to drive up to two external LED channels simultaneously. Second, it is not disabled during the Sleep or Deep Sleep states of operation (see [Section 6.1](#)). The third and final difference is it allows for different behaviors when the device is in Fully Active state versus when the device is in Sleep or Deep Sleep state.

5.3.1 LINKING LEDS TO CAPACITIVE TOUCH SENSORS

LEDs 1 - 7 can be optionally linked to Capacitive Touch Sensors 1-7 so that when the sensor detects a button press, the corresponding LED will be actuated at one of the programmed responses.

LEDs 9 and 10 may be optionally linked to the Grouped Sensors to indicate a slide / tap / press and hold in the “Up” or “Down” directions.

5.4 Capacitive Touch Sensing

The CAP1114 contains 14 independent Capacitive Touch Sensor inputs. Each sensor has dynamic range to detect a change of capacitance due to a touch. Additionally, each sensor can be configured to be automatically and routinely recalibrated.

5.4.1 MULTIPLE BUTTON PRESSES

If multiple sensor buttons (with a programmable threshold - see [Section 6.24](#)) are simultaneously detected, only the first N buttons that are detected are flagged. All other buttons are ignored. Furthermore, the device remembers which buttons were legitimate so new touches are not detected so long as N buttons are pressed.

Likewise, if too many (based on the programmed threshold - see [Section 6.24](#)) grouped sensor presses are detected, the device will block all press detections on the grouped buttons and cancel any current presses as if the sensor had been released.

5.4.2 LID CLOSURE

To detect lid closure or other similar events, lid closure sensor thresholds can be set. A Lid Closure Event can be flagged based on either a minimum number of sensors or on specific sensors simultaneously exceeding the lid closure threshold. An interrupt can also be generated. During a Lid Closure Event, all touches are blocked.

5.4.3 GROUPED SENSORS (CS8 - CS14)

Capacitive Touch Sensors 8 through 14 inclusive may be grouped as a single entity (which is the default state). Each sensor is sampled independently; however, for purposes of activation, recalibration, and repeat rates, all of them are treated as one group. The Group also has different controls and allows for different behavior such as sliding, tapping, or press and hold.

The grouped sensors may be ungrouped as described in [Section 5.6](#).

5.4.4 SENSING CYCLE

Each Capacitive Touch Sensor has controls to be activated and included in the sensing cycle. When the device is active, it automatically initiates a sensing cycle and repeats the cycle every time it finishes. The cycle polls through each active Sensor starting with CS1 and extending through CS14. As each Capacitive Touch Sensor is polled, its measurement is compared against a baseline “not touched” measurement. If the delta measurement is large enough, a touch is detected and an interrupt generated.

5.4.5 PROXIMITY DETECTION

Sensor CS1 can be configured to detect changes in capacitance due to proximity of a touch. This circuitry detects the change of capacitance that is generated as an object approaches, but does not physically touch, the CS1 sensor. When proximity detection is enabled, the signal is boosted by 8x to detect very small capacitance changes. Separate controls determine averaging and sensitivity for proximity (see [Section 6.36](#), “Proximity Control Register”).

5.4.6 RECALIBRATING SENSORS

Each sensor is regularly recalibrated at an adjustable rate. By default, the recalibration routine stores the average 256 previous measurements and periodically updates the base “Not Touched” setting for the Capacitive Touch Sensor input. This routine is disabled automatically if a touch is detected so the touch does not factor into the base “Not Touched” setting.

5.4.7 LOW FREQUENCY NOISE DETECTION

Each sensor has a noise detector that will sense if low frequency noise is injected onto the input with sufficient power to corrupt the readings. This noise detector has a fixed threshold above and below the rail that will trigger when noise is present. If low frequency noise is detected on a CS line, that sample is removed and not compared against the threshold.

5.4.8 RF NOISE DETECTION

Each sensor also contains an integrated RF noise detector. This block will detect injected RF noise on the CS pin. The detector threshold is dependent upon the noise frequency. If RF noise is detected on a CS line, that sample is removed and not compared against the threshold.

5.5 Grouped Sensor Behavior

The CAP1114 Grouped sensors (CS8 - CS14) can be configured to function as a single entity that operates differently than the individual button sensors (for ungrouped behavior see [Section 5.6](#)). When configured as a group these sensors function as a slider and offer three different interface functions associated with it. These functions are Tap, Press and Hold, or a Slide.

For purposes of a Tap or Press and Hold event, the “DOWN” side of the Grouped sensors are defined as CS8, CS9 and CS10. The “UP” side of the Grouped Sensors are defined as CS12, CS13, and CS14. CS11 is neither “UP” nor “DOWN” and a tap or press and hold event on CS11 will not cause either UP or DOWN status bits to be set.

For purposes of a slide, the “DOWN” direction is decreasing in CS channel number. Conversely, the “UP” direction is increasing in CS number.

APPLICATION NOTE: The Grouped Sensors will cause either the UP or DOWN status bits to be set but not both at the same time. In the case that a sensor on both the “UP” side of the slider and the “DOWN” side of the slider are touched simultaneously, neither the UP nor DOWN status bits will be set.

5.5.1 TAP

If a touch on any Grouped sensor is detected and held for less than or equal to the M_PRESS bit settings (default 245ms), a group press is detected, the TAP bit is set, and an interrupt is generated. Furthermore, the relative position on the slider is determined and the appropriate UP or DOWN status bits are set and the appropriate LED is actuated.

No further action is taken. If a slide is subsequently detected, the TAP status bit is cleared.

CAP1114

5.5.2 PRESS AND HOLD

If a touch on any Grouped sensor is held for longer than the M_PRESS bit settings (default 245ms), a Group Touch is detected and an interrupt is generated. Furthermore, the relative position on the slider is determined and the appropriate UP or DOWN status bits are set, the PH bit is set, and the appropriate LED is actuated.

So long as the Grouped sensor is held, it will flag an interrupt at the programmed repeat rate (as determined by the RPT_RATE_PH bit settings) indefinitely. Once the touch has been removed, the Group is returned to its normal operating condition.

The M_PRESS setting is important to distinguish between Tap, Press & Hold and Sliding. If M_PRESS is set too low, a Press & Hold may be detected during a slow slide. This will cause user confusion as the Slide direction and LED may change. Longer M_PRESS settings will ensure that the 3 Group behaviors are reliably distinct and will add more delay prior to the Press & Hold repeat interrupt generation.

5.5.3 SLIDER

The Grouped sensors have the capability to detect a slide in either the “UP” or “DOWN” direction as referenced by the sensor numbers that are used. For example, an “Up” direction slide would be detected if CS8 detected a touch, followed by CS9, then by CS10, etc. Likewise, a “Down” direction slide would be detected if CS10 detected a touch, followed by CS9, then by CS8, etc.

Slides in either direction are configured to flag an interrupt and to cause an LED to be actuated (separate for each direction). The Slide is detected independently of a Press and Hold or a Tap condition and only one condition may be present at any one time.

So long as a slide is maintained in either direction, it will flag an interrupt at the programmed repeat rate (as determined by the RPT_RATE_SL bit settings). If the slide is removed or changes direction, it will reset and return to normal operation.

5.5.4 RELATIVE POSITION

The CAP1114 has the option to indicate the relative position of a touch on the Grouped sensors. This value is stored either as a scaled number from 2 to 98 indicating where a tap, press and hold, or the end of a slide was detected or as a 8-bit number that represents volumetric data. When configured to store volumetric data, the user may write a base setting at any time that is modified based on Grouped sensor behavior (see [Section 6.4](#)).

5.5.5 SLIDER VELOCITY

The repeat rate can be dynamically increased based on the speed of a slide. This permits slow sliding motions to have precise, step-by-step volume control and faster motions to generate increasingly fast volume changes.

Two techniques are employed to increase the number of interrupts generated based on speed. First, the slide speed is measured and the repeat rate is increased to provide more interrupts for the same distance traveled relative to a slower slide. Second, additional interrupts are generated immediately after the slide ends to further increase the change in volume. The number of additional interrupts is based on slide speed; both of these dynamic slider behaviors are controlled by the Slider Velocity Register.

5.6 Ungrouped Sensor Behavior

The CAP1114 Grouped sensors have the option to be used as individual buttons. When the group is broken (via the VOL_UP_DOWN bit - see [Section 6.34](#)), buttons CS8 and CS14 will adopt one type of behavior while buttons CS9 - CS13 will adopt another. In all cases, a slide will not be detected.

5.6.1 CS9 - CS13 UNGROUPED BEHAVIOR

These buttons will cause the corresponding status bit in the Button Status 2 register (see [Section 6.2](#)) to be asserted when a touch is detected. This touch detection uses the button queue and button repeat rate settings. They will use the slider maximum duration and multiple touch settings.

5.6.2 CS8 AND CS14 UNGROUPED BEHAVIOR

CS8 and CS14 will generate interrupts based on the duration of the touch detected, similar to a Tap and Press and Hold events. Furthermore, these sensors will generate interrupts at the Grouped Sensors repeat rate based on whether a Tap or Press and Hold event has been detected.

If a touch is detected on CS8, the DOWN status bit will be set in addition to either TAP or PH.

If a touch is detected on CS14, the UP status bit will be set in addition to either TAP or PH.

Based on the multiple button touch settings (see [Section 6.24](#)), both CS8 and CS14 may detect a touch simultaneously and both UP and DOWN status bits may be set.

5.7 ALERT Pin

The ALERT pin is an active high output that is driven high when an interrupt event is detected. It is also used to wake the device from Deep Sleep state.

Whenever an interrupt is generated, the INT bit (see [Section 6.1](#)) is set. The ALERT pin is cleared when INT bit is cleared by the user. Additionally, when the INT bit is cleared by the user, status bits are cleared only if no press is detected.

5.7.1 BUTTON INTERRUPT BEHAVIOR

For non-grouped buttons, an interrupt is generated when a touch is detected. If the repeat rate is enabled (see [Section 6.14](#)), then, so long as the touch is held, another interrupt will be generated based on the programmed repeat rate (see [Figure 5-2](#)) and upon release.

5.7.2 GROUPED SENSOR INTERRUPT BEHAVIOR

For grouped sensors, an interrupt is generated upon initial detection of a tap, slide, or press and hold event. Then, subsequent interrupts are generated as follows:

1. For a slide event, an interrupt is generated based on the programmed repeat rate as well as the velocity of the slide operation. See [Figure 5-6](#) and [Figure 5-7](#). Additional interrupts are generated after the slide has finished. These extra interrupts are generated every round robin cycle (~35ms) and the number is determined by the speed of the slide.
2. For a tap event there are no further interrupts. See [Figure 5-4](#).
3. For a press and hold event, interrupts are generated based on the programmed repeat rate. If the repeat rate is disabled, no further interrupts are generated. See [Figure 5-5](#).

5.7.3 WAKE FROM DEEP SLEEP

When the ALERT pin is driven high from an external source, it is also used to wake the device from the Deep Sleep power state. When the device enters the Deep Sleep power state, the ALERT pin output is put into a high-Z mode. It requires a pull-down resistor to pull it to the inactive state. Furthermore, the CAP1114 will wait 5ms before it samples the ALERT pin for wake activity.

FIGURE 5-2: BUTTON INTERRUPT BEHAVIOR - REPEAT RATE ENABLED (DEFAULT)

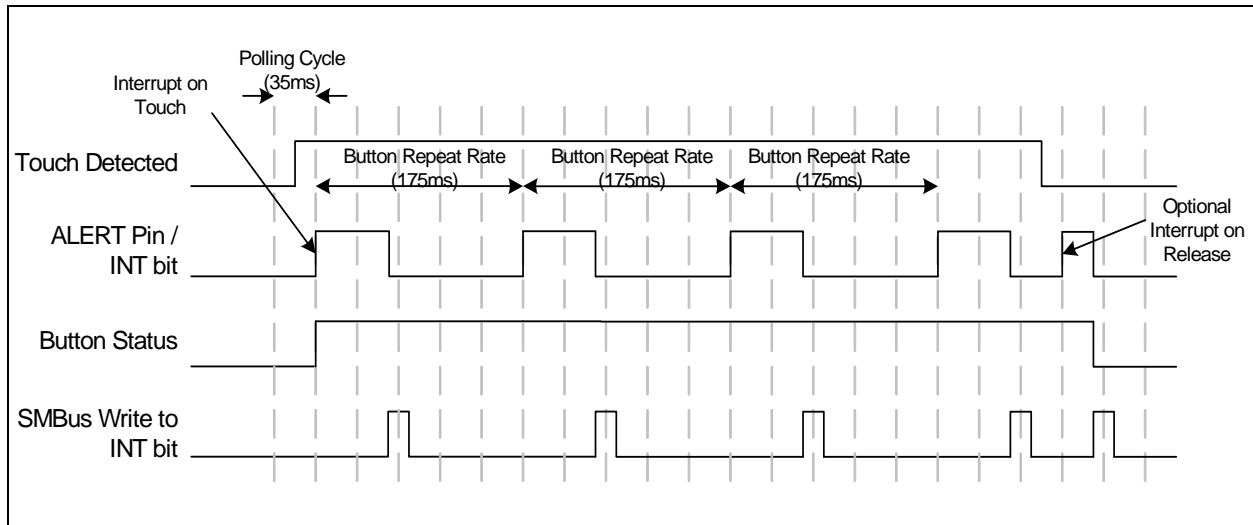

FIGURE 5-3: BUTTON INTERRUPT BEHAVIOR - NO REPEAT RATE ENABLED

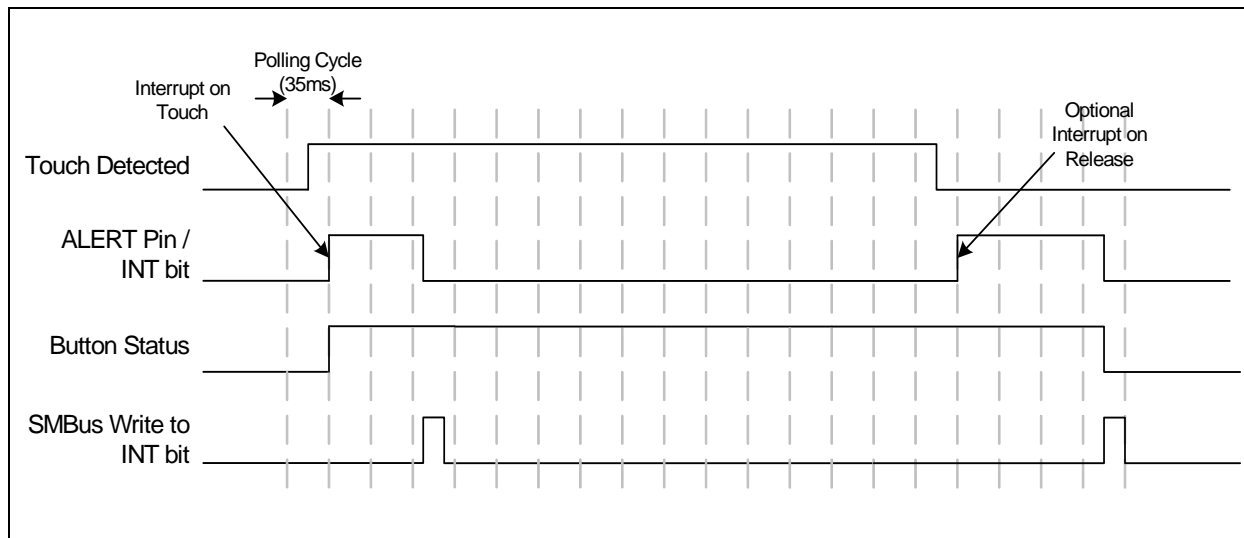

FIGURE 5-4: TAP INTERRUPT BEHAVIOR

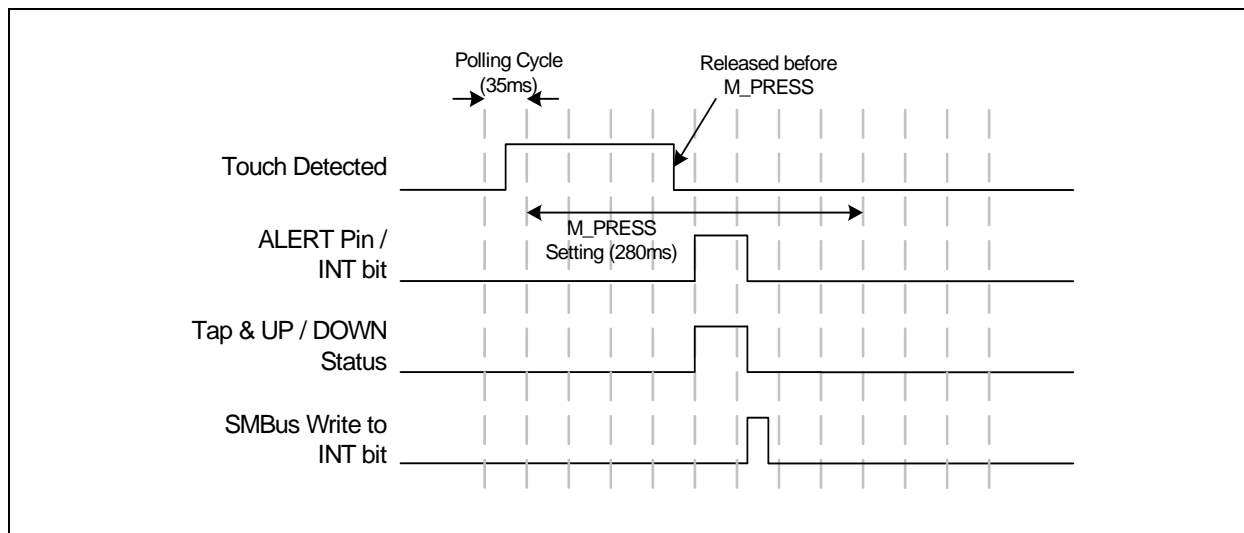

FIGURE 5-5: PRESS AND HOLD INTERRUPT BEHAVIOR

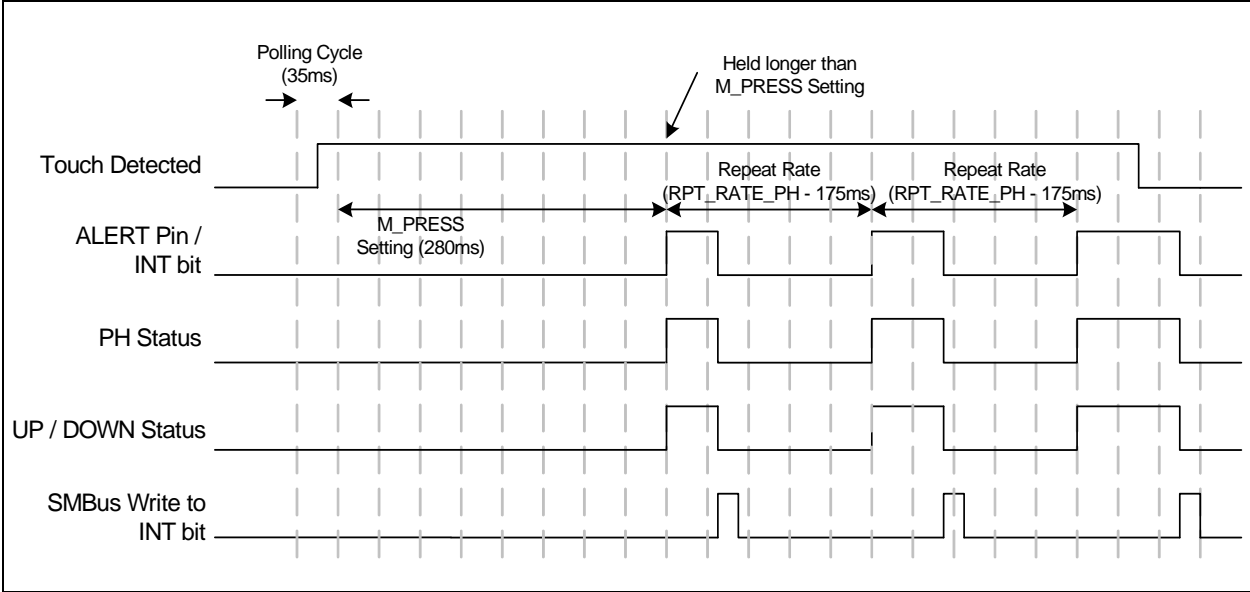

FIGURE 5-6: SLIDE INTERRUPT BEHAVIOR - NO ACCELERATION

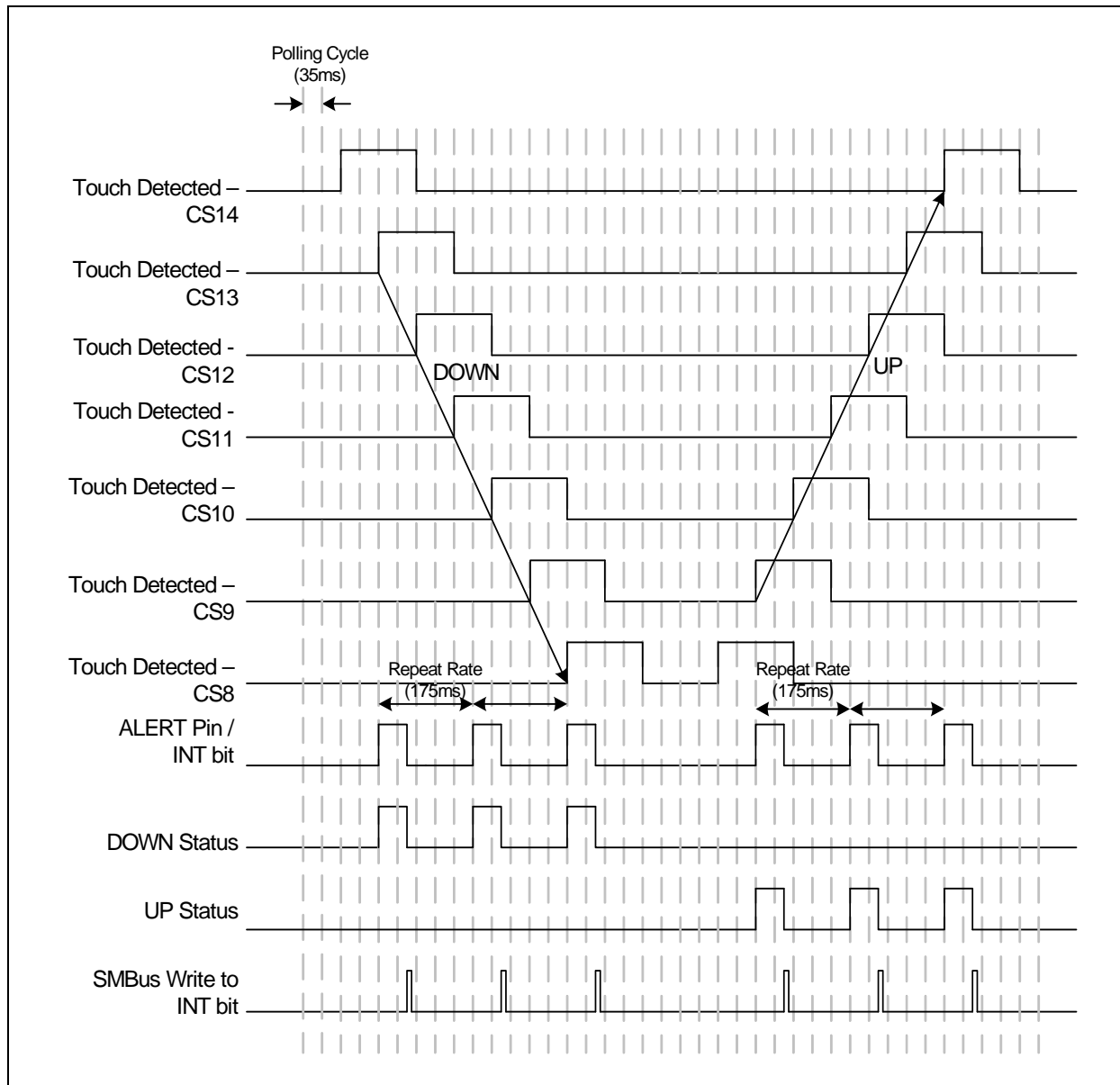
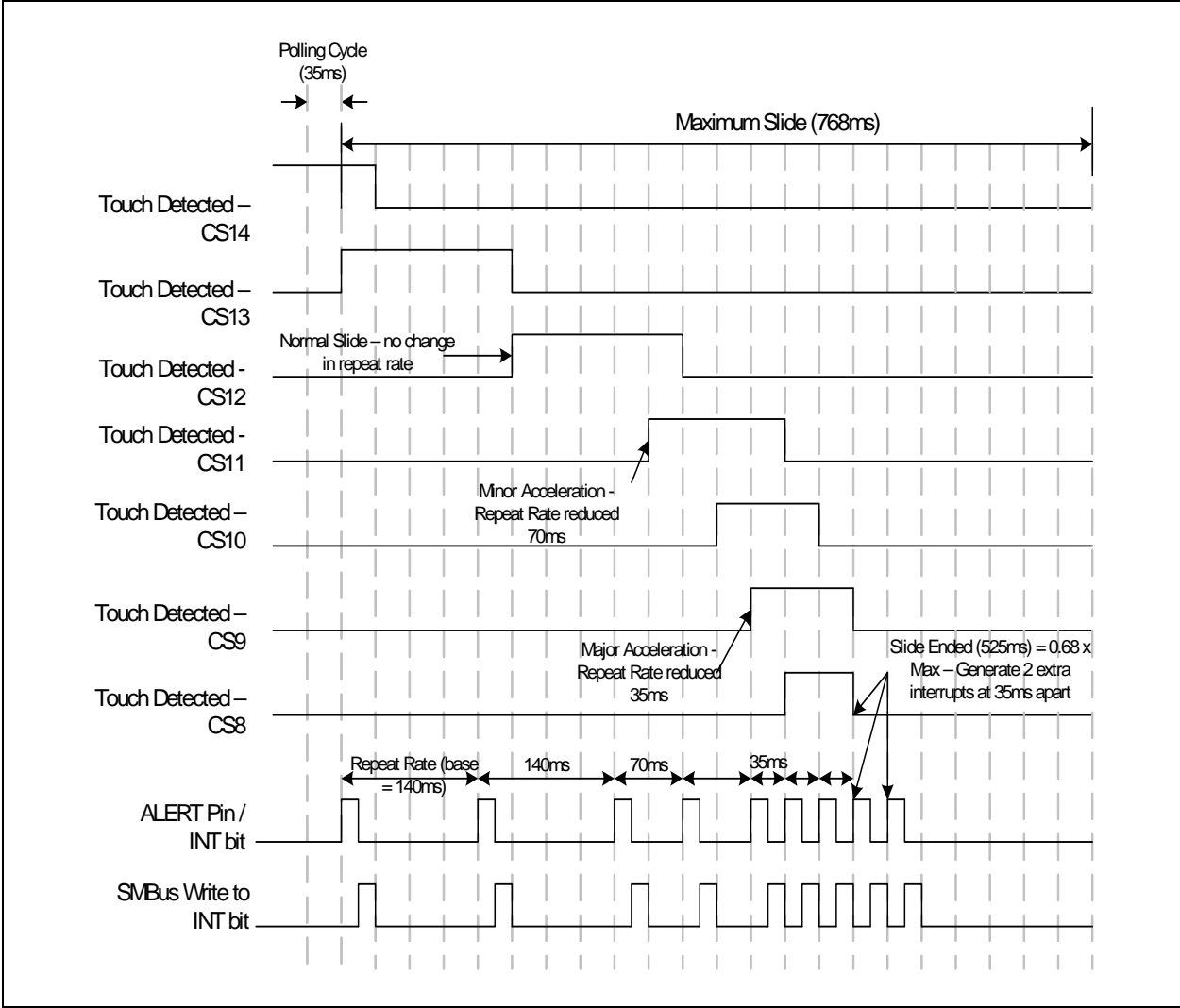

FIGURE 5-7: SLIDE INTERRUPT BEHAVIOR - ACCELERATION EXAMPLE



6.0 REGISTER DESCRIPTION

The registers shown in [Table 6-1](#) are accessible through the SMBus. An entry of '-' indicates that the bit is not used and will always read '0'.

TABLE 6-1: REGISTER SET IN HEXADECIMAL ORDER

Register Address	R/W	Register Name	Function	Default Value	Page
00h	R/W	Main Status Control	Controls general power states	00h	Page 31
03h	R	Button Status 1	Returns the state of the Cap Sensor group and buttons 1 - 6 and slider controls	00h	Page 32
04h	R	Button Status 2	Returns the state of buttons 7 - 14	00h	Page 32
05h	R	Build Revision	Stores the functional revision of the device build	10h	Page 33
06h	R-C / R/W	Slider Position / Volumetric Data	Returns the relative position of a press on the slider or volumetric data	00h	Page 33
08h	R	Vendor ID	Stores a fixed value that identifies Microchip	5Dh	Page 34
09h	R/W	Volumetric Step	Controls the step used for volumetric data increases for a slide	01h	Page 35
0Ah	R	Noise Status 1	Stores the noise flags for sensors 1 - 7	00h	Page 35
0Bh	R	Noise Status 2	Stores the noise flags for sensors 8 - 14	00h	Page 35
0Ch	R	Lid Closure Status 1	Stores lid closure status bits for sensors 1 - 7	00h	Page 35
0Dh	R	Lid Closure Status 2	Stores lid closure status bits for sensors 8 - 14	00h	Page 35
0Eh	R-C	GPIO Status	Stores the status of LED1 / GPIO1 through LED8 / GPIO8 pins	00h	Page 36
0Fh	R-C	Group Status	Returns the state of the Grouped sensors	00h	Page 36
10h	R	Sensor 1 Delta Count	Stores the delta count for CS1	00h	Page 37
11h	R	Sensor 2 Delta Count	Stores the delta count for CS2	00h	Page 37
12h	R	Sensor 3 Delta Count	Stores the delta count for CS3	00h	Page 37
13h	R	Sensor 4 Delta Count	Stores the delta count for CS4	00h	Page 37
14h	R	Sensor 5 Delta Count	Stores the delta count for CS5	00h	Page 37
15h	R	Sensor 6 Delta Count	Stores the delta count for CS6	00h	Page 37
16h	R	Sensor 7 Delta Count	Stores the delta count for CS7	00h	Page 37
17h	R	Sensor 8 Delta Count	Stores the delta count for CS8	00h	Page 37
18h	R	Sensor 9 Delta Count	Stores the delta count for CS9	00h	Page 37
19h	R	Sensor 10 Delta Count	Stores the delta count for CS10	00h	Page 37
1Ah	R	Sensor 11 Delta Count	Stores the delta count for CS11	00h	Page 37
1Bh	R	Sensor 12 Delta Count	Stores the delta count for CS12	00h	Page 37
1Ch	R	Sensor 13 Delta Count	Stores the delta count for CS13	00h	Page 37

TABLE 6-1: REGISTER SET IN HEXADECIMAL ORDER (CONTINUED)

Register Address	R/W	Register Name	Function	Default Value	Page
1Dh	R	Sensor 14 Delta Count	Stores the delta count for CS14	00h	Page 37
1Eh	R/W	Queue Control	Controls how many samples must exceed touch threshold for button press detections	03h	Page 37
1Fh	R/W	Data Sensitivity	Controls the sensitivity of the threshold and delta counts and data scaling of the base counts	2Fh	Page 38
20h	R/W	Configuration	Controls some recalibration and LED controls	29h	Page 39
21h	R/W	Sensor Enable	Controls whether the Capacitive Touch Sensor group and button inputs 1 - 7 are sampled	FFh	Page 40
22h	R/W	Button Configuration	Controls reset delay and auto-repeat delay for buttons	A4h	Page 41
23h	R/W	Group Configuration 1	Controls the detection dwell time before a press is detected within the group	47h	Page 42
24h	R/W	Group Configuration 2	Controls reset delay and auto-repeat delay for grouped sensors	D4h	Page 43
25h	R/W	Calibration Enable	Controls automatic calibration for grouped sensors and sensors 1 - 7	FFh	Page 43
26h	R/W	Calibration Activate	Activates manual re-calibration for grouped sensors and sensors 1 - 7	00h	Page 44
27h	R/W	Interrupt Enable 1	Enables Interrupts associated with the grouped sensors and sensors 1 - 7	FFh	Page 45
28h	R/W	Interrupt Enable 2	Enables Interrupts associated with GPIOs 1 - 8	00h	Page 45
29h	R/W	Sleep Channel Control	Determines the number and which channels are measured during Sleep	00h	Page 46
2Ah	R/W	Multiple Press Configuration	Determines the number of simultaneous presses to flag a multiple press condition	82h	Page 46
2Bh	R/W	Lid Closure Configuration	Controls Lid Closure detection and operation	00h	Page 47
2Ch	R/W	Lid Closure Queue Control	Controls how many samples must exceed the lid closure threshold for Button and Slider operation	02h	Page 48
2Dh	R/W	Lid Closure Pattern 1	Stores pattern bits for lid closure detection for channels 1 - 7	7Fh	Page 48
2Eh	R/W	Lid Closure Pattern 2	Stores pattern bits for lid closure detection for channels 8 - 14	7Fh	Page 48
2Fh	R/W	Recalibration Configuration	Determines re-calibration timing and sampling window	93h	Page 48
30h	R/W	Sensor 1 Threshold	Stores the delta count threshold to determine a touch for Capacitive Touch Sensor 1	40h	Page 49

TABLE 6-1: REGISTER SET IN HEXADECIMAL ORDER (CONTINUED)

Register Address	R/W	Register Name	Function	Default Value	Page
31h	R/W	Sensor 2 Threshold	Stores the delta count threshold to determine a touch for Capacitive Touch Sensor 2	40h	Page 49
32h	R/W	Sensor 3 Threshold	Stores the delta count threshold to determine a touch for Capacitive Touch Sensor 3	40h	Page 49
33h	R/W	Sensor 4 Threshold	Stores the delta count threshold to determine a touch for Capacitive Touch Sensor 4	40h	Page 49
34h	R/W	Sensor 5 Threshold	Stores the delta count threshold to determine a touch for Capacitive Touch Sensor 5	40h	Page 49
35h	R/W	Sensor 6 Threshold	Stores the delta count threshold to determine a touch for Capacitive Touch Sensor 6	40h	Page 49
36h	R/W	Sensor 7 Threshold	Stores the delta count threshold to determine a touch for Capacitive Touch Sensor 7	40h	Page 49
37h	R/W	Group Threshold	Stores the delta count threshold to determine a touch on any of the Grouped Sensors	40h	Page 49
38h	R/W	Button Noise Threshold 1	Stores controls for selecting the noise threshold for buttons 1 - 4	AAh	Page 50
39h	R/W	Button Noise Threshold 2	Stores controls for selecting the noise threshold for buttons 5 - 7 and the Grouped sensors	AAh	Page 50
3Ah	R/W	Lid Closure Threshold 1	Stores controls for selecting the lid closure threshold for buttons 1 - 4	AAh	Page 51
3Bh	R/W	Lid Closure Threshold 2	Stores controls for selecting the lid closure threshold for buttons 5 - 8	AAh	Page 51
3Ch	R/W	Lid Closure Threshold 3	Stores controls for selecting the lid closure threshold for buttons 9 - 12	AAh	Page 51
3Dh	R/W	Lid Closure Threshold 4	Stores controls for selecting the lid closure threshold for buttons 13 - 14	0Ah	Page 51
3Eh	R/W	Slider Velocity Configuration	Determines speed parameters for the slider	C5h	Page 52
3Fh	R/W	Digital Recalibration	Forces digital recalibration for all sensors	00h	Page 53
40h	R/W	Configuration 2	Stores additional controls for general operation	00h	Page 54
41h	R/W	Grouped Channel Sensor Enable	Stores controls to enable some or all sensors in the group	7Fh	Page 55
42h	R/W	Proximity Control	Controls the sensitivity settings for CS1	02h	Page 55
46h	R/W	Grouped Sensor Calibration Activate	Stores controls to force a calibration on the individual sensors in the Group	00h	Page 44
4Eh	R/W	Sampling Channel Select	Controls which channels are affected by the Sampling Configuration Register settings	00h	Page 56

TABLE 6-1: REGISTER SET IN HEXADECIMAL ORDER (CONTINUED)

Register Address	R/W	Register Name	Function	Default Value	Page
4Fh	R/W	Sampling Configuration	Changes the sampling time for one or more input channels	00h	Page 56
50h	R	Sensor 1 Base Count	Stores the reference count value for sensor 1	00h	Page 57
51h	R	Sensor 2 Base Count	Stores the reference count value for sensor 2	00h	Page 57
52h	R	Sensor 3 Base Count	Stores the reference count value for sensor 3	00h	Page 57
53h	R	Sensor 4 Base Count	Stores the reference count value for sensor 4	00h	Page 57
54h	R	Sensor 5 Base Count	Stores the reference count value for sensor 5	00h	Page 57
55h	R	Sensor 6 Base Count	Stores the reference count value for sensor 6	00h	Page 57
56h	R	Sensor 7 Base Count	Stores the reference count value for sensor 7	00h	Page 57
57h	R	Sensor 8 Base Count	Stores the reference count value for sensor 8	00h	Page 57
58h	R	Sensor 9 Base Count	Stores the reference count value for sensor 9	00h	Page 57
59h	R	Sensor 10 Base Count	Stores the reference count value for sensor 10	00h	Page 57
5Ah	R	Sensor 11 Base Count	Stores the reference count value for sensor 11	00h	Page 57
5Bh	R	Sensor 12 Base Count	Stores the reference count value for sensor 12	00h	Page 57
5Ch	R	Sensor 13 Base Count	Stores the reference count value for sensor 13	00h	Page 57
5Dh	R	Sensor 14 Base Count	Stores the reference count value for sensor 14	00h	Page 57
60h	R	LED Status 1	Stores status bits for LEDs 1 - 8	00h	Page 58
61h	R	LED Status 2	Stores status bits for LEDs 9 - 11	00h	Page 58
70h	R/W	LED / GPIO Direction	Controls the direction for LED1 / GPIO1 through LED8 / GPIO8	00h	Page 58
71h	R/W	LED / GPIO Output Type	Controls the output type for LED1 / GPIO1 through LED8 / GPIO8	00h	Page 59
72h	R	GPIO Input	Stores the pin state of LED1 / GPIO1 through LED8 / GPIO8	00h	Page 59
73h	R/W	LED Output Control 1	Controls the output state of the LED drivers 1 - 8	00h	Page 60
74h	R/W	LED Output Control 2	Controls the output state of the LED drivers 9 - 11	00h	Page 60
75h	R/W	LED Polarity 1	Controls the output polarity of LEDs 1 - 8	00h	Page 60
76h	R/W	LED Polarity 2	Controls the output polarity of LEDs 9 - 11	00h	Page 60
77h	R/W	Linked LED Transition Control 1	Controls transition effects of LEDs 1 - 7 when linked	00h	Page 62
78h	R/W	Linked LED Transition Control 2	Controls transition effects of LEDs 9 - 10 when linked	00h	Page 62

TABLE 6-1: REGISTER SET IN HEXADECIMAL ORDER (CONTINUED)

Register Address	R/W	Register Name	Function	Default Value	Page
79h	R/W	LED Mirror Control 1	Controls the duty cycle mirroring of LEDs 1 - 8	00h	Page 63
7Ah	R/W	LED Mirror Control 2	Controls the duty cycle mirroring of LEDs 9 - 11	00h	Page 63
80h	R/W	Sensor LED Linking	Controls linking of CS1 - CS7 to LED channels	00h	Page 64
81h	R/W	LED Behavior 1	Controls the behavior and response of LEDs 1 - 4	00h	Page 64
82h	R/W	LED Behavior 2	Controls the behavior and response of LEDs 5 - 8	00h	Page 64
83h	R/W	LED Behavior 3	Controls the behavior and response of LEDs 9 - 11	00h	Page 64
84h	R/W	LED Pulse 1 Period	Controls the period of each breathe during a pulse	20h	Page 66
85h	R/W	LED Pulse 2 Period	Controls the period of breath and pulse release operation	14h	Page 68
86h	R/W	LED Breathe Period	Controls the period of an LED breathe operation	5Dh	Page 69
88h	R/W	LED Configuration	Controls the number of pulses for the Pulse 1 and Pulse 2 LED behaviors	24h	Page 69
90h	R/W	LED Pulse 1 Duty Cycle	Determines the min and max duty cycle for the pulse operation	F0h	Page 69
91h	R/W	LED Pulse 2 Duty Cycle	Determines the min and max duty cycle for the breathe and pulse release operation	F0h	Page 69
92h	R/W	LED Breathe Duty Cycle	Determines the min and max duty cycle for the breathe operation	F0h	Page 69
93h	R/W	LED Direct Duty Cycle	Determines the min and max duty cycle for Direct mode LED operation	F0h	Page 69
94h	R/W	LED Direct Ramp Rates	Determines the rising and falling edge ramp rates of the LED	00h	Page 70
95h	R/W	LED Off Delay	Determines the off delay for all LED behaviors	00h	Page 71
B1h	R	Sensor 1 Calibration	Stores the high byte of the 10-bit value used to drive the analog portion of sensor 1	00h	Page 72
B2h	R	Sensor 2 Calibration	Stores the high byte of the 10-bit value used to drive the analog portion of sensor 2	00h	Page 72
B3h	R	Sensor 3 Calibration	Stores the high byte of the 10-bit value used to drive the analog portion of sensor 3	00h	Page 72
B4h	R	Sensor 4 Calibration	Stores the high byte of the 10-bit value used to drive the analog portion of sensor 4	00h	Page 72
B5h	R	Sensor 5 Calibration	Stores the high byte of the 10-bit value used to drive the analog portion of sensor 5	00h	Page 72

TABLE 6-1: REGISTER SET IN HEXADECIMAL ORDER (CONTINUED)

Register Address	R/W	Register Name	Function	Default Value	Page
B6h	R	Sensor 6 Calibration	Stores the high byte of the 10-bit value used to drive the analog portion of sensor 6	00h	Page 72
B7h	R	Sensor 7 Calibration	Stores the high byte of the 10-bit value used to drive the analog portion of sensor 7	00h	Page 72
B8h	R	Sensor 8 Calibration	Stores the high byte of the 10-bit value used to drive the analog portion of sensor 8	00h	Page 72
B9h	R	Sensor 9 Calibration	Stores the high byte of the 10-bit value used to drive the analog portion of sensor 9	00h	Page 72
BAh	R	Sensor 10 Calibration	Stores the high byte of the 10-bit value used to drive the analog portion of sensor 10	00h	Page 72
BBh	R	Sensor 11 Calibration	Stores the high byte of the 10-bit value used to drive the analog portion of sensor 11	00h	Page 72
BCh	R	Sensor 12 Calibration	Stores the high byte of the 10-bit value used to drive the analog portion of sensor 12	00h	Page 72
BDh	R	Sensor 13 Calibration	Stores the high byte of the 10-bit value used to drive the analog portion of sensor 13	00h	Page 72
BEh	R	Sensor 14 Calibration	Stores the high byte of the 10-bit value used to drive the analog portion of sensor 14	00h	Page 72
FDh	R	Product ID	Stores a fixed value that identifies each product	3Ah	Page 73
FEh	R	Manufacturer ID	Stores a fixed value that identifies Microchip	5Dh	Page 34
FFh	R	Revision	Stores a fixed value that represents the revision number	80h	Page 73

During Power-On-Reset (POR), the default values are stored in the registers. A POR is initiated when power is first applied to the part and the voltage on the VDD supply surpasses the POR level as specified in the electrical characteristics. Any reads to undefined registers will return 00h. Writes to undefined registers will not have an effect.

When a bit is “set”, this means that the user writes a logic ‘1’ to it. When a bit is “cleared”, this means that the user writes a logic ‘0’ to it.

6.1 Main Status Control Register

TABLE 6-2: MAIN STATUS CONTROL REGISTER

ADDR	R/W	Register	B7	B6	B5	B4	B3	B2	B1	B0	Default
00h	R/W	Main Status Control	-	DEACT	SLEEP	DSLEEP	-	-	PWR_LED	INT	00h

The Main Status and Control Register controls the primary power state of the device.

Bit 6 - DEACT - Deactivates all sensor scanning and LED activity.

- ‘0’ - (default) - Sensor scanning is active and LEDs are functional.
- ‘1’ - All sensor scanning is disabled and all linked LEDs are disabled (see [Section 6.48](#)). The only way to restart scanning is to clear this bit. The status registers are automatically cleared and the INT bit is cleared.

CAP1114

Bit 5 - SLEEP - Enables Sleep state by deactivating the LED activity and scanning those sensors enabled via the Sleep Control register.

- '0' (default) - Sensor scanning is active and LEDs are functional.
- '1' - All LEDs are disabled (except LED11) and the Capacitive Touch Sensor scanning is limited to the sensors set in the Sleep Channel Control register (see [Section 6.23](#)). The status registers will not be cleared.

Bit 4 - DSLEEP - Enables the Deep Sleep state by deactivating all functions.

- '0' (default) - Sensor scanning is active and LEDs are functional.
- '1' - All sensor scanning is disabled. Except for LED11, all LEDs are driven to their programmed non-actuated state and no PWM operations will be done. The device will return to its previous power state when the ALERT pin is driven to its active level (see [Section 5.7](#)). The status registers are automatically cleared and the INT bit is cleared. SMBus communications targeted at the CAP1114 will bring the device out of deep sleep and automatically clear this bit.

Bit 1 - PWR_LED - Controls the output of LED11 based on the state of bits 5 and 4.

- '0' (default) - The LED11 output is in the "inactive" or off state.
- '1' - The LED11 output is active in one of the following conditions:
 - a) Both bits 4 and 5 are set to a logic '0'. The LED will behave as defined by the LED11_CTL bits (see [Table 6-68](#)).
 - b) Either bit 4 or bit 5 is set to a logic '1'. The LED will behave as defined by the LED11_ALT bits (see [Table 6-68](#)).

Bit 0 - INT - Indicates that there is an interrupt. This bit is only set if the ALERT pin has been asserted. If a channel detects a press and its associated interrupt enable bit is set to a logic '0', no action is taken.

This bit is cleared by writing a logic '0' to it. When this bit is cleared, the ALERT pin will be deasserted and all status registers will be cleared if the condition has been removed.

- '0' - No interrupt pending.
- '1' - A button press has been detected on one or more channels and the interrupt has been asserted.

6.2 Button Status Registers

TABLE 6-3: BUTTON STATUS REGISTERS

ADDR	R/W	Register	B7	B6	B5	B4	B3	B2	B1	B0	Default
03h	R	Button Status 1	UP	DOWN	CS6	CS5	CS4	CS3	CS2	CS1	00h
04h	R	Button Status 2	CS14	CS13	CS12	CS11	CS10	CS9	CS8	CS7	00h

The Button Status Registers store status bits that indicate a button press has been detected. A value of '0' in any bit indicates that no button press has been detected. A value of '1' in any bit indicates that a button press has been detected.

All status bits are cleared when the device enters the Deep Sleep or Inactive states (DSLEEP = '1' or DEACT = '1' - see [Section 6.1](#)). All status bits are cleared when the INT bit is cleared and if a touch on the respective Capacitive Touch Sensor is no longer present. If a touch is still detected, the bits will not be cleared (but this will not cause the interrupt to be asserted - see [Section 6.14](#)).

APPLICATION NOTE: When the Button Status 1 Register is read, the Group Status register will be automatically cleared. Therefore, the Group Status register should be read prior to reading the Button Status Registers

6.2.1 BUTTON STATUS 1

Bit 7 - UP - Indicates that a slide was detected on increasing sensors (i.e. Sensor 8 -> Sensor 9 -> Sensor 10). This bit is also set if a press is detected on the "Up" portion of the slider. If the Group auto-repeat is enabled, the ALERT pin will be periodically asserted while a slide or press and hold event is still detected. This bit is sticky and will remain set until cleared. Once cleared, it will be re-set when another interrupt is generated in the "UP" direction. This bit is automatically cleared if the DOWN bit is set.

Bit 6 - DOWN - Indicates that a slide was detected on decreasing sensors (i.e. Sensor 14 -> Sensor 13-> Sensor 12). This bit is also set if a press is detected on the “Down” portion of the slider. If the Group auto-repeat is enabled, the ALERT pin will be periodically asserted while a slide or press and hold event is still detected. This bit is sticky and will remain set until cleared. Once cleared, it will be re-set when another interrupt is generated in the “DOWN” direction. This bit is automatically cleared if the UP bit is set.

Bit 5 - CS6 - Indicates that a press was detected on Sensor 6. This sensor can be linked to LED6.

- ‘0’ - A touch was not detected on the corresponding button.
- ‘1’ - A touch was detected on the corresponding button.

Bit 4 - CS5 - Indicates that a press was detected on Sensor 5. This sensor can be linked to LED5.

Bit 3 - CS4 - Indicates that a press was detected on Sensor 4. This sensor can be linked to LED4.

Bit 2 - CS3 - Indicates that a press was detected on Sensor 3. This sensor can be linked to LED3

Bit 1 - CS2 - Indicates that a press was detected on Sensor 2. This sensor can be linked to LED2.

Bit 0 - CS1 - Indicates that a press was detected on Sensor 1. This sensor can be linked to LED1.

6.2.2 BUTTON STATUS 2

Bit 7 - CS14 - Indicates that press was detected on Sensor 14. This sensor is part of the group which can be linked to LED9 and LED10.

Bit 6 - CS13 - Indicates that press was detected on Sensor 13. This sensor is part of the group which can be linked to LED9 and LED10.

Bit 5 - CS12 - Indicates that press was detected on Sensor 12. This sensor is part of the group which can be linked to LED9 and LED10.

Bit 4 - CS11 - Indicates that press was detected on Sensor 11. This sensor is part of the group which can be linked to LED9 and LED10.

Bit 3 - CS10 - Indicates that press was detected on Sensor 10. This sensor is part of the group which can be linked to LED9 and LED10.

Bit 2 - CS9 - Indicates that press was detected on Sensor 9. This sensor is part of the group which can be linked to LED9 and LED10.

Bit 1 - CS8 - Indicates that press was detected on Sensor 8. This sensor is part of the group which can be linked to LED9 and LED10.

Bit 0 - CS7 - Indicates that a press was detected on Sensor 7. This sensor can be linked to LED7.

6.3 Build Revision Register

TABLE 6-4: BUILD REVISION REGISTER

ADDR	R/W	Register	B7	B6	B5	B4	B3	B2	B1	B0	Default
05h	R	Build Revision	-	-	-	Build4	Build3	Build2	Build1	Build0	10h

The Build Revision Register indicates hardware defined settings that are used.

6.4 Slider Position / Volumetric Data Register

TABLE 6-5: SLIDER POSITION / VOLUMETRIC DATA REGISTER

ADDR	R/W	Register	B7	B6	B5	B4	B3	B2	B1	B0	Default
06h	R-C / R/W	Slider Position / Volumetric Data	-	POS[6:0]							00h

The Slider Position / Volumetric Data Register indicates the absolute position of a Tap, Slide, or Press and Hold event detected on the Grouped sensors (slider). Alternately, the register stores volumetric data that increases or decreased based on detected operations on the Grouped sensors (slider).

APPLICATION NOTE: When the device enters the Deep Sleep state, the Slider Position / Volumetric Data Register (06h) is cleared.

CAP1114

Bits 6-0 - POS[6:0] - Indicate absolute position or volumetric data as determined by the POS_VOL bit (see [Section 6.14](#)).

6.4.1 ABSOLUTE POSITION

The absolute position of a single touch is available from this register. By interpolating information from up to 3 adjacent buttons, 16 different positions are calculated by the CAP1114 from the center of one button to the center of each adjacent button. The bits will encode a range from 2 to 98 indicative of where the touch occurred. [Table 6-6](#) shows an example of the settings assuming a single button is pressed.

If a slide is detected on the Grouped sensors, the POS[6:0] bits will indicate the most recently touched sensor (i.e. where the slide ended) however will not indicate where the slide originated.

APPLICATION NOTE: The register will be cleared to a value of 00h when it is read. It will be set to a valid position when the next ALERT is generated. It will be updated at the respective repeat rate for a slide or press and hold event regardless of whether it has been read or not. Therefore, it will only show the position of the last touch detected at the time of the interrupt.

TABLE 6-6: EXAMPLE SLIDER ABSOLUTE POSITION DECODE

Touch Position	POS [6:0] Settings
CS8	02h (2d)
CS9	12h (18d)
CS10	22h (34d)
CS11	32h (50d)
CS12	42h (68d)
CS13	52h (82d)
CS14	62h (98d)

6.4.2 VOLUMETRIC DATA

If they are setup to present Volumetric Data (see [Section 6.14](#)), the bits will encode a range from 0 to 100. This value is updated based on the Grouped sensor activity:

- A slide in the “UP” direction will increase the volumetric data by the Volumetric Step setting (see [Section 6.6](#)) whenever an interrupt is generated (including extra interrupts generated after the slide is complete).
- A slide in the “DOWN” direction will decrease the volumetric data by the Volumetric Step setting (see [Section 6.6](#)) whenever an interrupt is generated (including extra interrupts generated after the slide is complete)
- A tap (see [Section 5.5.1](#)) on the “UP” side will increase the volumetric data by a value of 1.
- A tap on the “DOWN” side will decrease the volumetric data by a value of 1.
- A press and hold (see [Section 5.5.2](#)) on the “UP” side will increase the volumetric data by a value of 1 at every repeat rate interval.
- A press and hold (see [Section 5.5.2](#)) on the “DOWN” side will decrease the volumetric data by a value of 1 at every repeat rate interval.

The bits are read / write.

6.5 Vendor ID Register

TABLE 6-7: VENDOR ID REGISTER

ADDR	R/W	Register	B7	B6	B5	B4	B3	B2	B1	B0	Default
08h	R	Vendor ID	0	1	0	1	1	1	0	1	5Dh
FEh											

The Vendor ID Register stores an 8-bit value that represents Microchip.

6.6 Volumetric Step Register

TABLE 6-8: VOLUMETRIC STEP REGISTER

ADDR	R/W	Register	B7	B6	B5	B4	B3	B2	B1	B0	Default
09h	R/W	Volumetric Step	-	-	-	-	VOL_STEP[3:0]				01h

The Volumetric Step Register controls the size of a step to the volumetric data when a slide is detected in the UP and DOWN directions.

Bits 3 - 0 - VOL_STEP[3:0] - Determines the volumetric data step when a slide is detected. Each LSB corresponds to a value of ± 1 .

6.7 Noise Status Registers

TABLE 6-9: NOISE STATUS REGISTERS

ADDR	R/W	Register	B7	B6	B5	B4	B3	B2	B1	B0	Default
0Ah	R	Noise Status 1	S1_RF_NOISE	S7_NOISE	S6_NOISE	S5_NOISE	S4_NOISE	S3_NOISE	S2_NOISE	S1_NOISE	00h
0Bh	R	Noise Status 2	-	S14_NOISE	S13_NOISE	S12_NOISE	S11_NOISE	S10_NOISE	S9_NOISE	S8_NOISE	00h

The Noise Status Registers store status bits that are generated from the analog block if the detected noise is above the operating region of the analog detector. These bits indicate that the most recently received data from the sensor is invalid and should not be used for touch detection. Furthermore, so long as the bit is set for a particular channel, no decisions are made with the data. The queues are not updated, a touch is not detected, and a release is not detected.

These bits will also be set if RF noise is detected on any individual sensor. With the exception of CS1, these conditions are OR'd together when setting the bits. For CS1, the S1_RF_NOISE bit will be set when RF noise is detected, and the S1_NOISE bit will be set if the detected noise is above the operating region of the detector.

These bits are not sticky and will be cleared automatically if the analog block does not report a noise error.

APPLICATION NOTE: For the CAP1114-2, if the lid closure detection circuitry is enabled, these bits count as sensors above the lid closure count threshold even if the corresponding data count is not. If the corresponding data byte exceeds the lid closure threshold, it is not counted twice.

APPLICATION NOTE: Regardless of the state of the Noise Status bits, if low frequency noise is detected on a sensor, that sample will be discarded unless the BLK_ANA_NOISE bit is set. As well, if RF noise is detected on a sensor, that sample will be discarded unless the BLK_RF_NOISE bit is set.

6.8 Lid Closure Status Registers

TABLE 6-10: LID CLOSURE STATUS REGISTERS

ADDR	R/W	Register	B7	B6	B5	B4	B3	B2	B1	B0	Default
0Ch	R	Lid Closure Status 1	-	S7_LID	S6_LID	S5_LID	S4_LID	S3_LID	S2_LID	S1_LID	00h
0Dh	R	Lid Closure Status 2	-	S14_LID	S13_LID	S12_LID	S11_LID	S10_LID	S9_LID	S8_LID	00h

The Lid Closure Status Registers bits are only set if the lid closure detection circuitry is enabled (see [Section 6.25](#)). These status bits indicate that the corresponding Capacitive Touch Sensor exceeded the Lid Closure threshold. These bits will be set if a button press is detected because the Lid Closure threshold is a percentage of the Sensor Threshold.

These bits are used in combination with the Lid Closure Pattern register settings to determine when a Lid Closure Event is flagged (see [Section 6.27](#)).

CAP1114

These bits are not sticky and will be cleared automatically when the corresponding sensor count drops below the lid closure count threshold. The device does not flag a sensor as above or below the threshold until it has cycled through the queue (see [Section 6.26, "Lid Closure Queue Control Register"](#)).

APPLICATION NOTE: It is likely that recalibration will occur while the lid is closed, resulting in negative delta counts until recalibration takes place.

6.9 GPIO Status Register

TABLE 6-11: GPIO STATUS REGISTER

ADDR	R/W	Register	B7	B6	B5	B4	B3	B2	B1	B0	Default
0Eh	R-C	GPIO Status	GPIO8_STSTS	GPIO7_STSTS	GPIO6_STSTS	GPIO5_STSTS	GPIO4_STSTS	GPIO3_STSTS	GPIO2_STSTS	GPIO1_STSTS	00h

The GPIO Status Register bits are set whenever one of the GPIO inputs changes states. If the LEDx / GPIOx pin is not configured as a GPIO or as an input, the respective bit will be set to a logic '0'.

The bits are cleared when the register is read.

6.10 Group Status Register

TABLE 6-12: GROUP STATUS REGISTER

ADDR	R/W	Register	B7	B6	B5	B4	B3	B2	B1	B0	Default
0Fh	R-C	Group Status	LID	MULT	RESET	-	UP	DOWN	TAP	PH	00h

The Group Status Register indicates that one or more actions were detected on the Grouped sensors. The detectable actions are described in [Section 5.5](#) and [Section 5.6](#).

Bit 7 - LID - Indicates that a Lid Closure Event has been detected. This bit is sticky. When it is set, it will remain set until read. When a Lid Closure Event is detected, all new touches will be blocked.

Bit 6 - MULT - This bit is asserted if one or more touches are being blocked because greater than N buttons are simultaneously pressed.

Bit 5 - RESET - Indicates that the device has exited the reset state. This bit may be set via a power on reset or upon release of the RESET pin. When it is set, it will remain set until read.

Bit 3 - UP - Indicates that a slide was detected on increasing sensors (i.e. Sensor 8 -> Sensor 9 -> Sensor 10) or on CS14 when the Grouped sensors are ungrouped. This bit is also set if a touch (tap or press and hold event) is detected on the "Up" portion of the slider. If the Group auto-repeat is enabled, the ALERT pin will be periodically asserted while a slide or press and hold event is detected. This bit will be cleared when read and re-set when another interrupt is generated. This bit is cleared automatically if the DOWN bit is set.

Bit 2 - DOWN - Indicates that a slide was detected on decreasing sensors (i.e. Sensor 14 -> Sensor 13 -> Sensor 12) or on CS8 when the Grouped sensors are ungrouped. This bit is also set if a touch (tap or press and hold event) is detected on the "Down" portion of the slider. If the Group auto-repeat is enabled, the ALERT pin will be periodically asserted while a slide or press and hold event is detected. This bit will be cleared when read and re-set when another interrupt is generated. This bit is automatically cleared if the UP bit is set.

Bit 1 - TAP - Indicates that a tap was detected on one of the sensors within the Group. The relative position of the tap is indicated by the UP and DOWN bits so that a tap on the "UP" side of the group will assert the UP bit as well as the TAP bit. If the tap event is detected in the "center" of the slider that is neither "UP" nor "DOWN", the bit will be set; however, no interrupt will be generated. This bit is sticky and will remain set until read.

Bit 0 - PH - Indicates that a press and hold event was detected on one of the sensors within the Group. the relative position of the press is indicated by the UP and DOWN bits so a touch and hold on the "UP" side of the group will assert the UP bit as well as the PH bit. If the press and hold event is detected in the "center" of the slider that is neither "UP" nor "DOWN", the bit will be set; however, no interrupt will be generated. This bit is sticky and will remain set until read. If the condition is still present, this bit will be re-set when the interrupt is generated.

6.11 Sensor Delta Count Registers

TABLE 6-13: SENSOR DELTA COUNT REGISTERS

ADDR	R/W	Register	B7	B6	B5	B4	B3	B2	B1	B0	Default
10h	R	Sensor 1 Delta Count	Sign	64	32	16	8	4	2	1	00h
11h	R	Sensor 2 Delta Count	Sign	64	32	16	8	4	2	1	00h
12h	R	Sensor 3 Delta Count	Sign	64	32	16	8	4	2	1	00h
13h	R	Sensor 4 Delta Count	Sign	64	32	16	8	4	2	1	00h
14h	R	Sensor 5 Delta Count	Sign	64	32	16	8	4	2	1	00h
15h	R	Sensor 6 Delta Count	Sign	64	32	16	8	4	2	1	00h
16h	R	Sensor 7 Delta Count	Sign	64	32	16	8	4	2	1	00h
17h	R	Sensor 8 Delta Count	Sign	64	32	16	8	4	2	1	00h
18h	R	Sensor 9 Delta Count	Sign	64	32	16	8	4	2	1	00h
19h	R	Sensor 10 Delta Count	Sign	64	32	16	8	4	2	1	00h
1Ah	R	Sensor 11 Delta Count	Sign	64	32	16	8	4	2	1	00h
1Bh	R	Sensor 12 Delta Count	Sign	64	32	16	8	4	2	1	00h
1Ch	R	Sensor 13 Delta Count	Sign	64	32	16	8	4	2	1	00h
1Dh	R	Sensor 14 Delta Count	Sign	64	32	16	8	4	2	1	00h

The Sensor Delta Count Registers store the delta count that is compared against the threshold used to determine if a touch has been detected. The count value represents a change in input due to the capacitance associated with a touch on one of the sensors and is referenced to a calibrated base "Not touched" count value. The delta is an instantaneous change and is updated once per sensor per sensing cycle (see [Section 5.4.4](#) - sensor cycle).

The value presented is a standard 2's complement number. In addition, the value is capped at a value of 7Fh. A reading of 7Fh indicates that the sensitivity settings are too high and should be adjusted accordingly (see [Section 6.13](#)).

The value is also capped at a negative value of FFh for negative delta counts which may result upon a release.

6.12 Queue Control Register

TABLE 6-14: QUEUE CONTROL REGISTER

ADDR	R/W	Register	B7	B6	B5	B4	B3	B2	B1	B0	Default
1Eh	R/W	Button Queue Control	-	-	-	-	-	QUEUE_B[2:0]			03h

The Queue Control Register determines the number of consecutive samples for which a single sensor output is above the Sensor Threshold before a touch is detected. This is also used to determine the number of consecutive samples used to detect a button release. The queue applies independently to all channels.

Bits 2 - 0 - QUEUE_B[2:0] - The number of consecutive samples necessary to detect a touch. Default is 3 consecutive samples. See [Table 6-15](#).

TABLE 6-15: QUEUE_B BIT DECODE

QUEUE_B[2:0]			Number of Consecutive Readings > Threshold
2	1	0	
0	0	0	1
0	0	1	1
0	1	0	2
0	1	1	3 (default)
1	0	0	4
1	0	1	5
1	1	0	6
1	1	1	7

6.13 Data Sensitivity Registers

TABLE 6-16: DATA SENSITIVITY REGISTER

ADDR	R/W	Register	B7	B6	B5	B4	B3	B2	B1	B0	Default
1Fh	R/W	Data Sensitivity	-	DELTA_SENSE[2:0]			BASE_SHIFT[3:0]				2Fh

The Data Sensitivity Register controls the sensitivity of all button channels.

Bits 6- 4 DELTA_SENSE[2:0] - Controls the sensitivity of a touch detection. The sensitivity settings act to scale the relative delta count value higher or lower based on the system parameters. A setting of 000b is the most sensitive while a setting of 111b is the least sensitive (see [Table 6-17](#)). At the more sensitive settings, touches are detected for a smaller delta C corresponding to a “lighter” touch. These settings are more sensitive to noise and a noisy environment may flag more false touches than higher sensitivity levels.

APPLICATION NOTE: A value of 128x is the most sensitive setting available. At the most sensitive settings, the MSB of the Delta Count register represents 64 out of ~25,000 which corresponds to a touch of approximately 0.25% of the base capacitance (or a ΔC of 25fF from a 10pF base capacitance). Conversely, a value of 1x is the least sensitive setting available. At these settings, the MSB of the Delta Count register corresponds to a delta count of 8192 counts out of ~25,000 which corresponds to a touch of approximately 33% of the base capacitance (or a ΔC of 3.33pF from a 10pF base capacitance).

TABLE 6-17: DELTA_SENSE BIT DECODE

DELTA_SENSE[2:0]			Sensitivity Multiplier
2	1	0	
0	0	0	128x (most sensitive)
0	0	1	64x
0	1	0	32x (default)
0	1	1	16x
1	0	0	8x
1	0	1	4x
1	1	0	2x
1	1	1	1x - (least sensitive)

Bits 3 - 0 - BASE_SHIFT [3:0] - Controls the scaling and data presentation of the Base Count registers. The higher the value of these bits, the larger the range and the lower the resolution of the data presented. The scale factor represents the multiplier to the bit-weighting presented in these register descriptions. See [Table 6-18](#).

APPLICATION NOTE: The BASE_SHIFT[3:0] bits normally do not need to be updated. These settings will not affect touch detection or sensitivity. These bits are sometimes helpful in analyzing the Cap Sensing board performance and stability.

TABLE 6-18: BASE_SHIFT BIT DECODE

BASE_SHIFT[3:0]				Data Scaling Factor
3	2	1	0	
0	0	0	0	1x
0	0	0	1	2x
0	0	1	0	4x
0	0	1	1	8x
0	1	0	0	16x
0	1	0	1	32x
0	1	1	0	64x
0	1	1	1	128x
1	0	0	0	256x
All others				256x (default = 1111b)

6.14 Configuration Register

TABLE 6-19: CONFIGURATION REGISTER

ADDR	R/W	Register	B7	B6	B5	B4	B3	B2	B1	B0	Default
20h	R/W	Configuration	TIMEOUT	POS_VOL	BLK_DIG_NOISE	BLK_ANA_NOISE	MAX_DUR_EN_B	RPT_EN_B	MAX_DUR_EN_G	RPT_EN_G	29h

The Configuration Register controls general global functionality that affects the entire device.

Bit 7 - TIMEOUT - Enables the timeout and idle functionality of the SMBus protocol.

- '0' (default) - The SMBus timeout and idle functionality are disabled. The SMBus interface will not time out if the clock line is held low. Likewise, it will not reset if both the data and clock lines are held high for longer than 150us. This is used for I²C compliance.
- '1' - The SMBus timeout and idle functionality are enabled. The SMBus interface will time out if the clock line is held low for longer than 30ms. Likewise, it will reset if both the data and clock lines are held high for longer than 150us.

APPLICATION NOTE: The idle timeout does not apply to the Deep Sleep state. When the CAP1114 is operating in Deep Sleep, if the host communicates with a device other than the CAP1114 and no stop bit is set, the CAP1114 will not reset the protocol and, therefore, will not respond to communications until a stop bit is sent.

Bit 6 - POS_VOL - Determines the behavior of the POS[6:0] status bits when a Grouped sensor is activated - see [Section 6.4](#).

- '0' (default) - The POS[6:0] bits represent position information that indicates which sensor was touched or the last sensor touched during a slide.
- '1' - The POS[6:0] bits represent volumetric data. The Position / Volumetric Data register is read / write.

Bit 5 - BLK_DIG_NOISE - Determines whether the noise threshold is checked when determining whether to discard samples.

- '0' - The noise threshold is enabled and checked. If a sample is above the noise threshold, it is not included in the re-calibration routine.
- '1' (default) - The noise threshold is disabled. No samples are excluded from the re-calibration routine.

Bit 4 - BLK_ANA_NOISE - Determines whether the noise flag setting will block a touch detection as well as the analog calibration routine.

- '0' (default) If noise is detected on the low frequency noise detector, a touch is blocked on the corresponding channel and will force the analog calibration routine to retry. Note that this does not require the Noise Status register bits to be set.
- '1' - A touch is not blocked if low frequency noise is detected. Likewise, the analog calibration routine will not retry if the analog noise bit is set.

Bit 3 - MAX_DUR_EN_B - Determines whether the maximum duration recalibration is enabled for non-grouped sensors.

- '0' - The maximum duration recalibration functionality is disabled. A press may be held indefinitely and no re-calibration will be performed on any button.
- '1' (default) - The maximum duration recalibration functionality is enabled. If a press is held for longer than the MAX_DUR_B bit settings, the re-calibration routine will be restarted (see [Section 6.16](#)).

Bit 2 - RPT_EN_B - Determines whether repeat rate is enabled for all buttons.

- '0' (default) - Repeat rate is not enabled. An interrupt will be generated when a touch is detected.
- '1' - Repeat rate is enabled for all buttons.

Bit 1 - MAX_DUR_EN_G - Determines whether the maximum duration recalibration is enabled for grouped sensors.

- '0' (default) - The maximum duration recalibration functionality is disabled. A press may be held indefinitely and no re-calibration will be performed on any button.
- '1' - The maximum duration recalibration functionality is enabled. If a press is held for longer than the MAX_DUR_G bit settings, the re-calibration routine will be restarted (see [Section 6.18](#)).

Bit 0 - RPT_EN_G - Determines the interrupt mechanism used when a Press and Hold event is detected on a grouped sensor.

- '0' - An interrupt will be generated when a Press and Hold event is detected.
- '1' (default) - An interrupt will be generated when a Press and Hold event is detected and at the programmed repeat rate so long as the sensor is pressed.

6.15 Sensor Enable Register

TABLE 6-20: SENSOR ENABLE REGISTER

ADDR	R/W	Register	B7	B6	B5	B4	B3	B2	B1	B0	Default
21h	R/W	Sensor Enable	GP_EN	S7_EN	S6_EN	S5_EN	S4_EN	S3_EN	S2_EN	S1_EN	FFh

The Sensor Enable Register determines whether a Capacitive Touch Sensor input is included in the sampling cycle in the fully active state. The length of the sampling cycle is not affected by the number of sensors measured.

Bit 7 - GP_EN - Enables the Grouped Sensors to be included during the sampling cycle.

- '0' - All sensors in the grouped sensors will not be sampled regardless of the state of the VOL_UP_DOWN bit.
- '1' (default) - Grouped sensors will be sampled. Individual channels are enabled via the Group Sampling Enable register.

Bit 6 - S7_EN - Enables the CS7 input to be included during the sampling cycle.

- '0' - The CS7 input is not included in the sampling cycle.
- '1' (default) - The CS7 input is included in the sampling cycle.

Bit 5 - S6_EN - Enables the CS6 input to be included during the sampling cycle.

Bit 4 - S5_EN - Enables the CS5 input to be included during the sampling cycle.

Bit 3 - S4_EN - Enables the CS4 input to be included during the sampling cycle.

Bit 2 - S3_EN - Enables the CS3 input to be included during the sampling cycle.

Bit 1 - S2_EN - Enables the CS2 input to be included during the sampling cycle.

Bit 0 - S1_EN - Enables the CS1 input to be included during the sampling cycle.

6.16 Button Configuration Register

TABLE 6-21: BUTTON CONFIGURATION REGISTER

ADDR	R/W	Register	B7	B6	B5	B4	B3	B2	B1	B0	Default
22h	R/W	Button Configuration	MAX_DUR_B[3:0]				RPT_RATE_B[3:0]				A4h

The Button Configuration Register controls timings associated with the Capacitive Sensor channels 1 - 7 that are not Grouped.

Bits 7 - 4 - MAX_DUR_B [3:0] - (default 1010b) - Determines the maximum time that a button is allowed to be pressed until the Capacitive Touch sensor is recalibrated as shown in [Table 6-22](#).

Bits 3 - 0 - RPT_RATE_B[3:0] - (default 0100b) Determines the time duration between interrupt assertions when auto repeat is enabled. The resolution is 35ms the range is from 35ms to 560ms as shown in [Table 6-23](#).

TABLE 6-22: MAX_DUR_B AND MAX_DUR_G BIT DECODE

MAX_DUR_B[3:0] AND MAX_DUR_G[3:0]				Time before Recalibration
3	2	1	0	
0	0	0	0	560ms
0	0	0	1	840ms
0	0	1	0	1120ms
0	0	1	1	1400ms
0	1	0	0	1680ms
0	1	0	1	2240ms
0	1	1	0	2800ms
0	1	1	1	3360ms
1	0	0	0	3920ms
1	0	0	1	4480ms
1	0	1	0	5600ms (default for CS1 - CS7)
1	0	1	1	6720ms
1	1	0	0	7840ms
1	1	0	1	8906ms (default for Grouped Sensors)
1	1	1	0	10080ms
1	1	1	1	11200ms

TABLE 6-23: RPT_RATE_B / SL / PH BIT DECODE

RPT_RATE_B / RPT_RATE_SL / RPT_RATE_PH				Interrupt Repeat Rate
3	2	1	0	
0	0	0	0	35ms
0	0	0	1	70ms
0	0	1	0	105ms
0	0	1	1	140ms
0	1	0	0	175ms (default)

TABLE 6-23: RPT_RATE_B / SL / PH BIT DECODE (CONTINUED)

RPT_RATE_B / RPT_RATE_SL / RPT_RATE_PH				Interrupt Repeat Rate
3	2	1	0	
0	1	0	1	210ms
0	1	1	0	245ms
0	1	1	1	280ms
1	0	0	0	315ms
1	0	0	1	350ms
1	0	1	0	385ms
1	0	1	1	420ms
1	1	0	0	455ms
1	1	0	1	490ms
1	1	1	0	525ms
1	1	1	1	560ms

6.17 Group Configuration Register 1

TABLE 6-24: GROUP CONFIGURATION REGISTER 1

ADDR	R/W	Register	B7	B6	B5	B4	B3	B2	B1	B0	Default
23h	R/W	Group Configuration 1	RPT_RATE_PH[3:0]				M_PRESS[3:0]				47h

The Group Configuration 1 Register controls timings associated with the Capacitive Sensor channels 8 - 14 that are included in the group.

Bits 7-4 - RPT_RATE_PH[3:0] - (default 0100b) Determines the time duration between interrupt assertions when auto repeat is enabled. This setting applies when a press and hold condition is detected on the on the Grouped Sensors (see [Section 5.5](#)). The resolution is 35ms the range is from 35ms to 560ms as shown in [Table 6-23](#).

Bits 3- 0 - M_PRESS[3:0] - (default 0111b) - Determines the minimum amount of time that a sensor in the Group must detect a button press to detect a Press and Hold event. If the sensor detects a touch for longer than the M_PRESS[3:0] settings, a Press and Hold event is detected. This has no effect on whether a slide is detected within the group. If a slide is detected before or after the press has been confirmed, it is treated as a separate event.

This is the maximum amount of time that a sensor in the Group can detect a button press to differentiate between a tap and a press and hold. If a sensor detects a touch for less than or equal to the M_PRESS[3:0] settings, a Tap event is detected.

The resolution is 35ms the range is from 35ms to 560ms as shown in [Table 6-25](#).

TABLE 6-25: M_PRESS BIT DECODE

M_PRESS[3:0]				M_PRESS Time
3	2	1	0	
0	0	0	0	35ms
0	0	0	1	70ms
0	0	1	0	105ms
0	0	1	1	140ms
0	1	0	0	175ms
0	1	0	1	210ms
0	1	1	0	245ms
0	1	1	1	280ms (default)
1	0	0	0	315ms

TABLE 6-25: M_PRESS BIT DECODE (CONTINUED)

M_PRESS[3:0]				M_PRESS Time
3	2	1	0	
1	0	0	1	350ms
1	0	1	0	385ms
1	0	1	1	420ms
1	1	0	0	455ms
1	1	0	1	490ms
1	1	1	0	525ms
1	1	1	1	560ms

6.18 Group Configuration Register 2

TABLE 6-26: GROUP CONFIGURATION REGISTER 2

ADDR	R/W	Register	B7	B6	B5	B4	B3	B2	B1	B0	Default
24h	R/W	Group Configuration 2	MAX_DUR_G[3:0]				RPT_RATE_SL[3:0]				D4h

The Group Configuration 2 Register controls timings associated with the Capacitive Sensor channels 8 - 14 that are included in the group.

Bits 7 - 4 - MAX_DUR_G [3:0] - (default 1101b) - Determines the maximum time that a button is allowed to be pressed until the Capacitive Touch sensor is recalibrated as shown in [Table 6-22](#).

Bits 3 - 0 - RPT_RATE_SL[3:0] - (default 0100b) Determines the time duration between interrupt assertions when auto repeat is enabled. This setting applies when a slide is detected on the Grouped Sensors and acts as the base repeat rate that is adjusted based on the slide speed (see [Section 5.5.5](#)). The resolution is 35ms the range is from 35ms to 560ms as shown in [Table 6-23](#).

6.19 Calibration Enable Register

TABLE 6-27: CALIBRATION ENABLE REGISTER

ADDR	R/W	Register	B7	B6	B5	B4	B3	B2	B1	B0	Default
25h	R/W	Calibration Enable	G_CEN	S7_CEN	S6_CEN	S5_CEN	S4_CEN	S3_CEN	S2_CEN	S1_CEN	FFh

The Calibration Enable Register controls whether the indicated Capacitive Touch Sensor input is automatically re-calibrated. If a sensor is not enabled, the corresponding calibration enable bit is ignored.

Bit 7 - G_CEN - Enables all sensors in the group to be re-calibrated simultaneously.

- '0' - None of the grouped channels are automatically re-calibrated. They can be re-calibrated manually by setting the G_CAL bit.
- '1' (default) - All of the grouped channels are automatically re-calibrated as the CAP1114 samples.

Bit 6 - S7_CEN - Enables the CS7 input to be re-calibrated automatically.

- '0' - The CS7 input is not automatically re-calibrated.
- '1' (default) - The CS7 input is automatically re-calibrated as the CAP1114 samples.

Bit 5 - S6_CEN - Enables the CS6 input to be re-calibrated automatically.

Bit 4 - S5_CEN - Enables the CS5 input to be re-calibrated automatically.

Bit 3 - S4_CEN - Enables the CS4 input to be re-calibrated automatically.

Bit 2 - S3_CEN - Enables the CS3 input to be re-calibrated automatically.

Bit 1 - S2_CEN - Enables the CS2 input to be re-calibrated automatically.

Bit 0 - S1_CEN - Enables the CS1 input to be re-calibrated automatically.

6.20 Calibration Activate Registers

TABLE 6-28: CALIBRATION ACTIVATE REGISTERS

ADDR	R/W	Register	B7	B6	B5	B4	B3	B2	B1	B0	Default
26h	R/W	Calibration Activate	G_CAL	S7_CAL	S6_CAL	S5_CAL	S4_CAL	S3_CAL	S2_CAL	S1_CAL	00h
46h	R/W	Grouped Sensor Calibration Activate		S14_CAL	S13_CAL	S12_CAL	S11_CAL	S10_CAL	S9_CAL	S8_CAL	00h

The Calibration Activate Registers force the respective sensors to be re-calibrated. When a bit is set, the corresponding Capacitive Touch Sensor will be re-calibrated and the bit will be automatically cleared once the re-calibration routine has finished. This calibration routine will update the internal analog controls and gain settings followed by a digital calibration to capture the base count for touch detection. During the re-calibration routine, the sensors will not detect a press for up to 600ms and the Sensor Base Count register values will be invalid. During this time, any press on the corresponding sensors will invalidate the re-calibration.

6.20.1 CALIBRATION ACTIVATE - 26H

Bit 7 - G_CAL - When set, all sensors in the group are re-calibrated. This bit is automatically cleared once all of the sensors in the group have been re-calibrated successfully.

Bit 6 - S7_CAL - When set, the CS7 input is re-calibrated. This bit is automatically cleared once the sensor has been re-calibrated successfully.

Bit 5 - S6_CAL - When set, the CS6 input is re-calibrated. This bit is automatically cleared once the sensor has been re-calibrated successfully.

Bit 4 - S5_CAL - When set, the CS5 input is re-calibrated. This bit is automatically cleared once the sensor has been re-calibrated successfully.

Bit 3 - S4_CAL - When set, the CS4 input is re-calibrated. This bit is automatically cleared once the sensor has been re-calibrated successfully.

Bit 2 - S3_CAL - When set, the CS3 input is re-calibrated. This bit is automatically cleared once the sensor has been re-calibrated successfully.

Bit 1 - S2_CAL - When set, the CS2 input is re-calibrated. This bit is automatically cleared once the sensor has been re-calibrated successfully.

Bit 0 - S1_CAL - When set, the CS1 input is re-calibrated. This bit is automatically cleared once the sensor has been re-calibrated successfully.

6.20.2 GROUPED SENSOR CALIBRATION ACTIVATE - 46H

Bit 6 - S14_CAL - When set, the CS14 input is re-calibrated. This bit is automatically cleared once the sensor has been re-calibrated successfully.

Bit 5 - S13_CAL - When set, the CS13 input is re-calibrated. This bit is automatically cleared once the sensor has been re-calibrated successfully.

Bit 4 - S12_CAL - When set, the CS12 input is re-calibrated. This bit is automatically cleared once the sensor has been re-calibrated successfully.

Bit 3 - S11_CAL - When set, the CS11 input is re-calibrated. This bit is automatically cleared once the sensor has been re-calibrated successfully.

Bit 2 - S10_CAL - When set, the CS10 input is re-calibrated. This bit is automatically cleared once the sensor has been re-calibrated successfully.

Bit 1 - S9_CAL - When set, the CS9 input is re-calibrated. This bit is automatically cleared once the sensor has been re-calibrated successfully.

Bit 0 - S8_CAL - When set, the CS8 input is re-calibrated. This bit is automatically cleared once the sensor has been re-calibrated successfully.

6.21 Interrupt Enable Registers

TABLE 6-29: INTERRUPT ENABLE REGISTERS

ADDR	R/W	Register	B7	B6	B5	B4	B3	B2	B1	B0	Default
27h	R/W	Interrupt Enable 1	G_INT_EN	S7_INT_EN	S6_INT_EN	S5_INT_EN	S4_INT_EN	S3_INT_EN	S2_INT_EN	S1_INT_EN	FFh
28h	R/W	Interrupt Enable 2	GPIO8_INT_EN	GPIO7_INT_EN	GPIO6_INT_EN	GPIO5_INT_EN	GPIO4_INT_EN	GPIO3_INT_EN	GPIO2_INT_EN	GPIO1_INT_EN	00h

The Interrupt Enable Registers determine whether a button press or GPIO input changing state causes the interrupt pin to be asserted.

6.22 Interrupt Enable 1

Bit 7 - G_INT_EN - Enables the interrupt pin to be asserted if a slide, tap, or press and hold action is detected on the grouped sensors.

- '0' - The interrupt pin will not be asserted if a slide, tap, or press and hold action is detected on the grouped sensors (associated with the UP, DOWN, TAP, and PH status bits).
- '1' (default) - The interrupt pin will be asserted if a slide, tap, or press and hold event is detected on the grouped sensors (associated with the UP, DOWN, TAP, and PH status bits).

Bit 6 - S7_INT_EN - Enables the interrupt pin to be asserted if a touch is detected on CS7 (associated with the CS7 status bit).

- '0' - The interrupt pin will not be asserted if a touch is detected on CS7 (associated with the CS7 status bit).
- '1' (default) - The interrupt pin will be asserted if a touch is detected on CS7 (associated with the CS7 status bit).

Bit 5 - S6_INT_EN - Enables the interrupt pin to be asserted if a touch is detected on CS6 (associated with the CS6 status bit).

Bit 4 - S5_INT_EN - Enables the interrupt pin to be asserted if a touch is detected on CS5 (associated with the CS5 status bit).

Bit 3 - S4_INT_EN - Enables the interrupt pin to be asserted if a touch is detected on CS4 (associated with the CS4 status bit).

Bit 2 - S3_INT_EN - Enables the interrupt pin to be asserted if a touch is detected on CS3 (associated with the CS3 status bit).

Bit 1 - S2_INT_EN - Enables the interrupt pin to be asserted if a touch is detected on CS2 (associated with the CS2 status bit).

Bit 0 - S1_INT_EN - Enables the interrupt pin to be asserted if a touch is detected on CS1 (associated with the CS1 status bit).

6.22.1 INTERRUPT ENABLE 2

These bits enable the interrupt pin to be asserted when the GPIOx status bit has been set.

Bit 7 - GPIO8_INT_EN - Enables the interrupt pin to be asserted if the GPIO8 status bit has been set.

- '0' (default) - The interrupt pin will not be asserted if the GPIO8 status bit has been set.
- '1' - The interrupt pin will be asserted if the GPIO8 status bit has been set.

Bit 6 - GPIO7_INT_EN - Enables the interrupt pin to be asserted if the GPIO7 status bit has been set.

Bit 5 - GPIO6_INT_EN - Enables the interrupt pin to be asserted if the GPIO6 status bit has been set.

Bit 4 - GPIO5_INT_EN - Enables the interrupt pin to be asserted if the GPIO5 status bit has been set.

Bit 3 - GPIO4_INT_EN - Enables the interrupt pin to be asserted if the GPIO4 status bit has been set.

Bit 2 - GPIO3_INT_EN - Enables the interrupt pin to be asserted if the GPIO3 status bit has been set.

Bit 1 - GPIO2_INT_EN - Enables the interrupt pin to be asserted if the GPIO2 status bit has been set.

Bit 0 - GPIO1_INT_EN - Enables the interrupt pin to be asserted if the GPIO1 status bit has been set.

6.23 Sleep Channel Control Register

TABLE 6-30: SLEEP CHANNEL CONTROL REGISTER

ADDR	R/W	Register	B7	B6	B5	B4	B3	B2	B1	B0	Default
29h	R/W	Sleep Channel Control	GR_SLEEP	S7_SLEEP	S6_SLEEP	S5_SLEEP	S4_SLEEP	S3_SLEEP	S2_SLEEP	S1_SLEEP	00h

The Sleep Channel Control Register determines which sensors are sampled when the device is placed into the Sleep state.

APPLICATION NOTE: If this register is updated while the device is in the Sleep state, the conversion cycle may be extended or for the first measurement of the new Capacitive Touch Sensors. It will correct itself on subsequent measurement cycles.

APPLICATION NOTE: If this register is updated while the device is in the Sleep state, it is recommended to force a recalibration routine on newly activated channels.

Bit 7 - GR_SLEEP - Enables the Grouped sensors to be sampled when the device is placed into the Sleep state.

- '0' (default) - Grouped Sensors are not sampled when the device is in the Sleep state.
- '1' - The Grouped Sensors are sampled when the device is in Sleep mode. If a tap, slide, or touch and hold is detected, the appropriate status bit is set and an interrupt generated. Individual sensors will be enabled via the Group Sensor Enable register.

Bit 6 - S7_SLEEP - Enables the CS7 sensor to be sampled when the device is placed into sleep mode.

- '0' (default) - The CS7 input is not sampled when the device is in the Sleep state
- '1' - The CS7 input is sampled when the device is in Sleep mode. If a touch is detected, the status bit is set and an interrupt generated.

Bit 5 - S6_SLEEP - Enables the CS6 sensor to be sampled when the device is placed into the Sleep state.

Bit 4 - S5_SLEEP - Enables the CS5 sensor to be sampled when the device is placed into the Sleep state.

Bit 3 - S4_SLEEP - Enables the CS4 sensor to be sampled when the device is placed into the Sleep state.

Bit 2 - S3_SLEEP - Enables the CS3 sensor to be sampled when the device is placed into the Sleep state.

Bit 1 - S2_SLEEP - Enables the CS2 sensor to be sampled when the device is placed into the Sleep state.

Bit 0 - S1_SLEEP - Enables the CS1 sensor to be sampled when the device is placed into the Sleep state.

6.24 Multiple Touch Configuration Register

TABLE 6-31: MULTIPLE TOUCH CONFIGURATION REGISTER

ADDR	R/W	Register	B7	B6	B5	B4	B3	B2	B1	B0	Default
2Ah	R/W	Multiple Touch Config	MULT_BLK_EN	-	-	-	B_MULT_T[1:0]	G_MULT_T[1:0]			82h

The Multiple Touch Configuration Register controls the settings for the multiple touch detection circuitry. These settings determine the number of sensors associated with this detection and the CAP1114 device behavior.

Bit 7 - MULT_BLK_EN - Enables the multiple button blocking circuitry.

- '0' - The multiple touch circuitry is disabled. The device will not block multiple touches.
- '1' (default) - The multiple touch circuitry is enabled. The device will accept the number of touches equal to programmed multiple touch threshold and block all others. It will remember which sensor is valid and block all others until that sensor has been released.

Bits 3 - 2 - B_MULT_T[1:0] - Determines the number of simultaneous touches on all buttons (excluding the Grouped buttons) before a Multiple Touch Event is flagged. If the number of multiple buttons touches is greater than the threshold value, a Multiple Touch Event is flagged. The bit decode is given by [Table 6-32](#).

TABLE 6-32: B_MULT_T BIT DECODE

B_MULT_T[1:0]		Number of Simultaneous Touches
1	0	
0	0	1 (default)
0	1	2
1	0	3
1	1	4

Bits 1 - 0 - G_MULT_T[1:0] - Determines the number of simultaneous touches on all Grouped buttons before a Multiple Touch Event is flagged. If the number of multiple buttons touches is greater than the threshold value, a Multiple Touch Event is flagged. The bit decode is given by [Table 6-33](#).

TABLE 6-33: G_MULT_T BIT DECODE

G_MULT_T[1:0]		Number of Simultaneous Touches
1	0	
0	0	2
0	1	3
1	0	4 (default)
1	1	1

6.25 Lid Closure Configuration Register

TABLE 6-34: LID CLOSURE CONFIGURATION REGISTER

ADDR	R/W	Register	B7	B6	B5	B4	B3	B2	B1	B0	Default
2Bh	R/W	Lid Closure Config	LID_CLOSE	-	-	-	-	-	COMP_PTRN	LID_ALERT	00h

The Lid Closure Configuration Register controls the settings for the lid closure detection circuitry.

Bit 7 - LID_CLOSE - Enables the lid closure circuitry.

- '0' (default) - The lid closure circuitry is disabled.
- '1' The lid closure circuitry is enabled. The device will use the Lid Closure Status registers in combination with the Lid Closure Pattern register settings to determine when a Lid Closure Event is flagged. In addition, the Noise Status bits are associated with lid closure.

Bit 1 - COMP_PTRN - Determines how the Lid Closure Status registers are compared against the Lid Closure Pattern registers. See [Section 6.27](#) for details on how the Lid Closure Pattern registers are used.

- '0' (default) - The Lid Closure Status registers are not compared directly against the Lid Closure Pattern registers. Instead, the number of bits in the Lid Closure Status registers is compared to the number of bits in the Lid Closure Pattern registers to determine whether a Lid Closure Event is flagged.
- '1' - The Lid Closure Status registers are compared directly against the Lid Closure Pattern registers. If the bits set in the Lid Closure Pattern are also set in the Lid Status registers, a Lid Closure Event is flagged.

Bit 0 - LID_ALERT - Enables an interrupt if a Lid Closure Event occurs.

- '0' (default) - If a Lid Closure Event occurs, the ALERT pin is not asserted.
- '1' - If a Lid Closure Event occurs, the ALERT pin will be asserted.

6.26 Lid Closure Queue Control Register

TABLE 6-35: LID CLOSURE QUEUE CONTROL REGISTER

ADDR	R/W	Register	B7	B6	B5	B4	B3	B2	B1	B0	Default
2Ch	R/W	Lid Closure Queue Control	-	-	-	-	-	QUEUE_L_B[2:0]			02h

The Lid Closure Queue Control Register determines the number of consecutive samples for which a single sensor output is above the Lid Closure Threshold before it is flagged.

A value of 0000b is decoded as 1.

Bits 2 - 0 - QUEUE_L[2:0] - The number of consecutive samples from an individual sensor necessary to set the Lid Closure status bit associated with the sensor. The queue applies individually to all sensors (including both buttons and grouped sensors) and applies to setting and clearing the respective status bit. The queue can range from 1 sample to 8 consecutive samples with a default of 2 consecutive samples.

6.27 Lid Closure Pattern Registers

TABLE 6-36: LID CLOSURE PATTERN REGISTERS

ADDR	R/W	Register	B7	B6	B5	B4	B3	B2	B1	B0	Default
2Dh	R/W	Lid Closure Pattern 1	-	S7_LM	S6_LM	S5_LM	S4_LM	S3_LM	S2_LM	S1_LM	7Fh
2Eh	R/W	Lid Closure Pattern 2		S14_LM	S13_LM	S12_LM	S11_LM	S10_LM	S9_LM	S8_LM	7Fh

The Lid Closure Pattern Registers act as a pattern to identify an expected sensor profile that is consistent with lid closure. They are only used when lid closure is enabled (see [Section 6.25, "Lid Closure Configuration Register"](#)). There are two methods for how the Lid Closure Status Registers are used with the Lid Closure Pattern registers: as specific sensors that must exceed the lid closure threshold or as the number of sensors that must exceed the lid closure threshold. Which method is used is based on bit 1 in the Lid Closure Configuration Register. The methods are described below. A Lid Closure Event is flagged in the Group Status register (see [Section 6.10, "Group Status Register"](#)).

1. Specific Sensors: If the bits set in the Lid Closure Pattern are also set in the Lid Status registers, a Lid Closure Event is flagged.
 2. Number of Sensors: The number of bits in the Lid Closure Status registers is compared to the number of bits in the Lid Closure Pattern registers to determine whether a Lid Closure Event is flagged. If any one of the conditions below is met, the Lid Closure Event is flagged.
 - If the number of bits in Lid Closure Status 1 register equals or exceeds the number of bits in the Lid Closure Pattern 1 register, a Lid Closure Event is flagged. In other words, if the number of simultaneous sensors 1-7 exceeding the lid closure threshold meets or exceeds the number of bits in the Lid Closure Pattern 1 register, a Lid Closure Event is flagged.
 - If the number of bits in Lid Closure Status 2 register equals or exceeds the number of bits in the Lid Closure Pattern 2 register, a Lid Closure Event is flagged. In other words, if the number of simultaneous grouped sensors 8-14 exceeding the lid closure threshold meets or exceeds the number of bits in the Lid Closure Pattern 2 register, a Lid Closure Event is flagged.
 - If the total number of bits in both the Lid Closure Status 1 and 2 registers equals or exceeds the total number of bits in both the Lid Closure Pattern 1 and 2 registers, a Lid Closure Event is flagged. In other words, if the total number of sensors above the lid closure threshold is greater than or equal to the number of sensors required for both Lid Closure Patterns, a Lid Closure Event is flagged.
- A value of 00h in both registers will effectively disable the Lid Closure circuitry and clear the LID status bit.

6.28 Recalibration Configuration Register

TABLE 6-37: RECALIBRATION CONFIGURATION REGISTER

ADDR	R/W	Register	B7	B6	B5	B4	B3	B2	B1	B0	Default
2Fh	R/W	Recalibration Configuration	BUT_LD_TH	GP_LD_TH	-	NEG_DELTA_CNT[1:0]		CAL_CFG[2:0]			93h

The Recalibration Configuration Register controls the automatic re-calibration routine settings as well as advanced controls to program the Sensor Threshold register settings and interrupt behavior.

Bit 7 - BUT_LD_TH - Enables setting all button Sensor Threshold registers by writing to the Sensor 1 Threshold register.

- '0' - Each Sensor X Threshold register is updated individually.
- '1' (default) - Writing the Sensor 1 Threshold register will automatically overwrite the Sensor Threshold registers for all buttons (Sensor Threshold 1 through Sensor Threshold 7). The individual Sensor X Threshold registers (Sensor 2 Threshold through Sensor 7 Threshold) can be individually updated at any time.

Bit 6 - GP_LD_TH - Enables setting the Group Threshold register by writing to the Sensor 1 Threshold register.

- '0' (default) - The Group Threshold register is updated independently of the Sensor 1 Threshold register.
- '1' - Writing the Sensor 1 Threshold register automatically overwrites the Group Threshold register settings.

Bits 4 - 3 - NEG_DELTA_CNT[1:0] - Determines the number of negative delta counts necessary to trigger a digital re-calibration as shown in [Table 6-38](#).

TABLE 6-38: NEG_DELTA_CNT BIT DECODE

NEG_DELTA_CNT[1:0]		Number of Consecutive Negative Delta Count Values
1	0	
0	0	8
0	1	16
1	0	32 (default)
1	1	None (disabled)

Bits 2 - 0 - CAL_CFG[2:0] - Determines the update time and number of samples of the automatic re-calibration routine. The settings apply to all sensors universally (though individual sensors and the group can be configured to support re-calibration - see [Section 6.19](#)).

TABLE 6-39: CAL_CFG BIT DECODE

CAL_CFG[2:0]			Recalibration Samples (See Note 6-1)	Update Time (See Note 6-2)
2	1	0		
0	0	0	16	16
0	0	1	32	32
0	1	0	64	64
0	1	1	256	256 (default)
1	0	0	256	1024
1	0	1	256	2048
1	1	0	256	4096
1	1	1	256	7936

Note 6-1 Recalibration Samples refers to the number of samples that are measured and averaged before the Base Count is updated.

Note 6-2 Update Time refers to the amount of time (in polling cycle periods) that elapses before the Base Count is updated.

6.29 Sensor Threshold Registers

TABLE 6-40: SENSOR THRESHOLD REGISTERS

ADDR	R/W	Register	B7	B6	B5	B4	B3	B2	B1	B0	Default
30h	R/W	Sensor 1 Threshold	-	64	32	16	8	4	2	1	40h
31h	R/W	Sensor 2 Threshold	-	64	32	16	8	4	2	1	40h

TABLE 6-40: SENSOR THRESHOLD REGISTERS (CONTINUED)

ADDR	R/W	Register	B7	B6	B5	B4	B3	B2	B1	B0	Default
32h	R/W	Sensor 3 Threshold	-	64	32	16	8	4	2	1	40h
33h	R/W	Sensor 4 Threshold	-	64	32	16	8	4	2	1	40h
34h	R/W	Sensor 5 Threshold	-	64	32	16	8	4	2	1	40h
35h	R/W	Sensor 6 Threshold	-	64	32	16	8	4	2	1	40h
36h	R/W	Sensor 7 Threshold	-	64	32	16	8	4	2	1	40h
37h	R/W	Group Threshold	-	64	32	16	8	4	2	1	40h

The Sensor Threshold Registers store the delta threshold that is used to determine if a touch has been detected. When a touch occurs, the input signal of the corresponding sensor changes due to the capacitance associated with a touch. If the sensor input change exceeds the threshold settings, a touch is detected.

When the BUT_LD_TH bit is set (see [Section 6.28](#) - bit 7), writing data to the Sensor 1 Threshold register will update all of the button threshold registers (31h - 36h inclusive).

When the GP_LD_TH bit is set (see [Section 6.28](#) - bit 6), writing data to the Sensor 1 Threshold register (30h) will update the Group Threshold register (37h) and the CS14 Threshold register (40h).

Individual button registers may be updated independently of the Sensor 1 Threshold settings. Similarly, the Up and Down Threshold registers may be updated independently of the Group Threshold register.

6.30 Button Noise Threshold Registers

TABLE 6-41: BUTTON NOISE THRESHOLD REGISTERS

ADDR	R/W	Register	B7	B6	B5	B4	B3	B2	B1	B0	Default
38h	R/W	Button Noise Threshold 1	CS4_BN_TH [1:0]		CS3_BN_TH [1:0]		CS2_BN_TH [1:0]		CS1_BN_TH [1:0]		AAh
39h	R/W	Button Noise Threshold 2	GR_BN_TH [1:0]		CS7_BN_TH [1:0]		CS6_BN_TH [1:0]		CS5_BN_TH [1:0]		AAh

The Button Noise Threshold Registers control the value of a secondary internal threshold to detect noise and improve the automatic recalibration routine. If a Capacitive Touch Sensor output exceeds the Button Noise Threshold but does not exceed the sensor threshold, it is determined to be caused by a noise spike. That sample is not used by the automatic re-calibration routine.

The Button Noise Threshold is proportional to the programmed threshold as shown in [Table 6-42](#).

TABLE 6-42: CSX_BN_TH BIT DECODE

CSX_BN_TH[1:0]		Threshold Divide Setting
1	0	
0	0	6.25%
0	1	12.5%
1	0	25% (default)
1	1	50%

6.30.1 BUTTON NOISE THRESHOLD 1 REGISTER

The Button Noise Threshold 1 Register controls the noise threshold for Capacitive Touch Sensors 1-4.

Bits 7-6 - CH4_BN_TH[1:0] - Controls the noise threshold for Capacitive Touch Sensor 4.

Bits 5-4 - CH3_BN_TH[1:0] - Controls the noise threshold for Capacitive Touch Sensor 3.

Bits 3-2 - CH2_BN_TH[1:0] - Controls the noise threshold for Capacitive Touch Sensor 2.

Bits 1-0 - CH1_BN_TH[1:0] - Controls the noise threshold for Capacitive Touch Sensor 1.

6.30.2 BUTTON NOISE THRESHOLD 2 REGISTER

The Button Noise Threshold 2 Register controls the noise threshold for Capacitive Touch Sensors 5 - 7 and the Grouped sensors.

Bits 7-6 - GR_BN_TH[1:0] - Controls the noise threshold for all grouped Capacitive Touch Sensors.

Bits 5-4 - CH7_BN_TH[1:0] - Controls the noise threshold for Capacitive Touch Sensor 7.

Bits 3-2 - CH6_BN_TH[1:0] - Controls the noise threshold for Capacitive Touch Sensor 6.

Bits 1-0 - CH5_BN_TH[1:0] - Controls the noise threshold for Capacitive Touch Sensor 5.

6.31 Lid Closure Threshold Registers

TABLE 6-43: LID CLOSURE THRESHOLD REGISTERS

ADDR	R/W	Register	B7	B6	B5	B4	B3	B2	B1	B0	Default
3Ah	R/W	Lid Closure Threshold 1	CS4_LD_TH [1:0]		CS3_LD_TH [1:0]		CS2_LD_TH [1:0]		CS1_LD_TH [1:0]		AAh
3Bh	R/W	Lid Closure Threshold 2	CS8_LD_TH [1:0]		CS7_LD_TH [1:0]		CS6_LD_TH [1:0]		CS5_LD_TH [1:0]		AAh
3Ch	R/W	Lid Closure Threshold 3	CS12_LD_TH [1:0]		CS11_LD_TH [1:0]		CS10_LD_TH [1:0]		CS9_LD_TH [1:0]		AAh
3Dh	R/W	Lid Closure Threshold 4	-	-	-	-	CS14_LD_TH [1:0]		CS13_LD_TH [1:0]		0Ah

The Lid Closure Threshold Registers control the value of a secondary internal threshold to detect noise potentially generated by lid closure. If a Capacitive Touch Sensor output exceeds the Lid Closure Threshold, the appropriate status bit is set in the Lid Closure Status register (see [Section 6.8](#)).

The Lid Closure Threshold is proportional to the programmed Sensor Threshold as shown in [Table 6-44](#).

TABLE 6-44: CSX_LD_TH BIT DECODE

CSX_LD_TH[1:0]		Threshold Divide Setting
1	0	
0	0	6.25%
0	1	12.5%
1	0	25% (default)
1	1	50%

6.31.1 LID CLOSURE THRESHOLD 1 REGISTER

The Lid Closure Threshold 1 Register controls the lid closure threshold for Capacitive Touch Sensors 1-4.

Bits 7-6 - CS4_LD_TH[1:0] - Controls the lid closure threshold for Capacitive Touch Sensor 4.

Bits 5-4 - CS3_LD_TH[1:0] - Controls the lid closure threshold for Capacitive Touch Sensor 3.

Bits 3-2 - CS2_LD_TH[1:0] - Controls the noise threshold for Capacitive Touch Sensor 2.

Bits 1-0 - CS1_LD_TH[1:0] - Controls the noise threshold for Capacitive Touch Sensor 1.

6.31.2 LID CLOSURE THRESHOLD 2 REGISTER

The Lid Closure Threshold 2 Register controls the lid closure threshold for Capacitive Touch Sensors 5 - 8.

Bits 7-6 - CS8_LD_TH[1:0] - Controls the lid closure threshold for Capacitive Touch Sensor 8 (one of the grouped sensors).

Bits 5-4 - CS7_LD_TH[1:0] - Controls the lid closure threshold for Capacitive Touch Sensor 7.

CAP1114

Bits 3-2 - CS6_LD_TH[1:0] - Controls the lid closure threshold for Capacitive Touch Sensor 6.

Bits 1-0 - CS5_LD_TH[1:0] - Controls the lid closure threshold for Capacitive Touch Sensor 5.

6.31.3 LID CLOSURE THRESHOLD 3 REGISTER

The Lid Closure Threshold 3 Register controls the lid closure threshold for Capacitive Touch Sensors 9 - 12.

Bits 7-6 - CS12_LD_TH[1:0] - Controls the lid closure threshold for Capacitive Touch Sensor 12 (one of the grouped sensors).

Bits 5-4 - CS11_LD_TH[1:0] - Controls the lid closure threshold for Capacitive Touch Sensor 11 (one of the grouped sensors).

Bits 3-2 - CS10_LD_TH[1:0] - Controls the lid closure threshold for Capacitive Touch Sensor 10 (one of the grouped sensors).

Bits 1-0 - CS9_LD_TH[1:0] - Controls the lid closure threshold for Capacitive Touch Sensor 9 (one of the grouped sensors).

6.31.4 LID CLOSURE THRESHOLD 4 REGISTER

The Lid Closure Threshold 4 Register controls the lid closure threshold for Capacitive Touch Sensors 13 - 14.

Bits 3-2 - CS14_LD_TH[1:0] - Controls the lid closure threshold for Capacitive Touch Sensor 14 (one of the grouped sensors).

Bits 1-0 - CS13_LD_TH[1:0] - Controls the lid closure threshold for Capacitive Touch Sensor 13 (one of the grouped sensors).

6.32 Slider Velocity Configuration Register

TABLE 6-45: SLIDER VELOCITY CONFIGURATION REGISTER

ADDR	R/W	Register	B7	B6	B5	B4	B3	B2	B1	B0	Default
3Eh	R/W	Slider Velocity Configuration	ACC_INT_EN	MAX_INT[2:0]		SLIDE_TIME [1:0]		RPT_SCALE [1:0]			C5h

The Slider Velocity Configuration Register controls the speed sensitive behaviors of the slider, allowing the number of interrupts to be increased as the slide speed increases.

Bit 7 - ACC_INT_EN - Enables the device to generate extra interrupts after an accelerated slide has been detected.

- '0' - The device will not generate extra interrupts during or after the slide has been detected.
- '1' (default) - The device will generate extra interrupts after an accelerated slide is detected. The number of extra interrupts generated will be proportional to the speed of the accelerated slide but will not exceed the maximum number of extra interrupts as determined by the MAX_INT bits.

Bits 6-4 - MAX_INT[2:0] - (default 100b) Determine the maximum number of extra interrupts that will be generated after a single slide (regardless of length). The variable "T" is the actual slide time and the parameter SLIDE_TIME is set by bits [3:2] of this register.

TABLE 6-46: MAX_INT BIT DECODE

MAX_INT[2:0]			Max # Interrupts	# Interrupts for T < 1/2 SLIDE_TIME	# Interrupts for 1/2 < T < 3/4 SLIDE_TIME	# Interrupts for 3/4 < T < FULL SLIDE_TIME
2	1	0				
0	0	0	0	0	0	0
0	0	1	1	1	0	0
0	1	0	2	2	1	0
0	1	1	3	3	1	0
1	0	0	4	4	2	1
1	0	1	5	5	2	1
1	1	0	6	6	3	1
1	1	1	7	7	3	1

Bits 3-2 - SLIDE_TIME[1:0] - (default 01b) - Determines how fast a slide must be to generate extra interrupts. This is the maximum slide time that will result in extra interrupts being generated. If the slide time is greater than SLIDE_TIME, no extra interrupts will be generated.

TABLE 6-47: SLIDE_TIME BIT DECODE

SLIDE_TIME[1:0]		Approximate Slide Time (msec)
1	0	
0	0	350
0	1	560 (default)
1	0	770
1	1	980

Bits 1 - 0 - RPT_SCALE[1:0] - (default 01b) - Determines how much to increase the Repeat Rate based on slide speed. The slide speed is determined by counting how many sensors are touched in approximately 100msec. The Repeat Rate is then increased various amounts based on the RPT_SCALE parameter.

When read in [Table 6-48](#), the repeat rate given is the number of measurement cycles between interrupts generated.

TABLE 6-48: RPT_SCALE BIT DECODE

Number of Sensors in 100msec	Repeat Rate (msec) RPT_SCALE[1:0]			
	00	01	10	11
>=5	35	35	35	35
4	35	35	35	70
3	35	35	70	105
2	35	70	105	140
1	RPT_RATE_SL			

Note 6-3 If the repeat rate for the slider is set at 105msec or lower, the 11b case will use the fixed values of 140, 105 and 70msec, respectively.

6.33 Digital Recalibration Control Register

TABLE 6-49: DIGITAL RECALIBRATION CONTROL REGISTER

ADDR	R/W	Register	B7	B6	B5	B4	B3	B2	B1	B0	Default
3Fh	R/W	Digital Recalibration Control	GP_D_CAL	CS7_D_CAL	CS6_D_CAL	CS5_D_CAL	CS4_D_CAL	CS3_D_CAL	CS2_D_CAL	CS1_D_CAL	00h

The Digital Recalibration Control Register forces channels to perform a digital calibration as if there were no base count. When a bit is set, the corresponding Capacitive Touch Sensor will be re-calibrated and the bit will be automatically cleared once the re-calibration routine has finished. This calibration routine will update the base count for touch detection.

Bit 7 - GP_D_CAL - Forces the grouped sensors to perform a digital recalibration as if there were no base count.

Bit 6 - CS7_D_CAL - Forces CS7 to perform a digital recalibration as if there were no base count.

Bit 5 - CS6_D_CAL - Forces CS6 to perform a digital recalibration as if there were no base count.

Bit 4 - CS5_D_CAL - Forces CS5 to perform a digital recalibration as if there were no base count.

Bit 3 - CS4_D_CAL - Forces CS4 to perform a digital recalibration as if there were no base count.

Bit 2 - CS3_D_CAL - Forces CS3 to perform a digital recalibration as if there were no base count.

Bit 1 - CS2_D_CAL - Forces CS2 to perform a digital recalibration as if there were no base count.

Bit 1 - CS1_D_CAL - Forces CS1 to perform a digital recalibration as if there were no base count.

6.34 Configuration 2 Register

TABLE 6-50: CONFIGURATION 2 REGISTER

ADDR	R/W	Register	B7	B6	B5	B4	B3	B2	B1	B0	Default
40h	R/W	Configuration 2	INV_LINK_TRAN	-	-	BLK_POL_MIR	SHOW_RF_NOISE	BLK_RF_NOISE	VOL_UP_DOWN	INT_REL_n	00h

Bit 7 - INV_LINK_TRAN - Determines the behavior of the Linked LED Transition controls (see [Section 6.46, "Linked LED Transition Control Registers"](#)).

- '0' (default) - When set, the Linked LED Transition controls set the min duty cycle equal to the max duty cycle.
- '1' - When set, the Linked LED Transition controls will invert the touch signal. For example, a touch signal will be inverted to a non-touched signal.

Bit 4 - BLK_POL_MIR - Determines whether the LED Mirror Control register bits are linked to the LED Polarity bits.

- '0' (default) - When the LED Polarity controls are set, the corresponding LED Mirror control is automatically set. Likewise, when the LED Polarity controls are cleared, the corresponding LED Mirror control is cleared.
- '1' - When the LED Polarity controls are changed, the corresponding LED Mirror control is not automatically changed.

Bit 3 - SHOW_RF_NOISE - Determines whether the Noise Status bits will show RF Noise as the only input source.

- '0' (default) - The Noise Status registers will show both RF noise and low frequency noise if either is detected on a Capacitive Touch Sensor channel.
- '1' - The Noise Status registers will only show RF noise if it is detected on a Capacitive Touch Sensor channel. Generic noise will still be detected and touches will be blocked normally; however, the status bits will not be updated.

Bit 2 - BLK_RF_NOISE - Blocks the analog RF noise detector from preventing touches.

- '0' (default) - If RF noise is detected by the analog block, any pending touch is blocked on the corresponding channel. During the analog calibration routine, RF Noise will cause it to retry. Note that this does not require that Noise Status bits be set.
- '1' - A touch is not blocked even if RF noise is detected. Likewise, the analog calibration routine will not retry if RF noise is detected.

Bit 1 - VOL_UP_DOWN - Determines how the Grouped Sensors are to be used.

- '0' (default) - The grouped sensors are used as a slider. All seven of the sensors are sampled together and may be disabled as a whole using the GP_EN (see [Section 6.15](#)) or GSLEEP (see [Section 6.23](#)) controls or individually (using the Grouped Sensor Channel Enable register - see [Section 6.35](#)). Alternately, each sensor may be disabled individually via the Group Sensor Channel Enable register. They will use the Group Threshold settings for all touch detections.
- '1' - The grouped sensors are used as separate sensors and are not grouped. They will behave as follows:
 1. Each sensor will flag individual interrupts when a touch is detected. They will set the corresponding status bit in the Button Status 2 register.
 2. The UP / DOWN, TAP, or PH status bits will not be set for CS9, CS10, CS11, CS12, or CS13. No slide will be detected.
 3. Each sensor will use the Group Threshold settings.
 4. Each sensor can be individually enabled / disabled via the Grouped Sensor Enable register settings.
 5. All sensors except CS8 and CS14 will use the button queue controls and repeat rates.
 6. The CS8 and CS14 sensors will use the tap and press and hold logic as well as the group repeat rate settings.
 7. All sensors will use the group max duration settings if this feature is enabled via the MAX_DUR_EN_G bit.
 8. For CS8 and CS14, interrupts will be generated in the same way as they would be for a TAP or Press and Hold event. This means that an interrupt will be generated on a touch. If the button is held, interrupts will be generated at the Group Repeat rate until the button is released. These buttons do not use the INT_REL_n control and will only generate an interrupt when a touch is detected.
 9. The CS8 sensor will be the designated "DOWN" button. When a tap or Press and Hold event is detected, it will cause the DOWN status bit to be set. The TAP and PH status bits will be set normally.

10. The CS14 sensor will be the designated “UP” button. When a Tap or Press and Hold event is detected, it will cause the UP status bit to be set. The TAP and PH status bits will be set normally.

Bit 0 - INT_REL_n - Controls the interrupt behavior when a release is detected on a button.

- ‘0’ (default) - An interrupt is generated when a press is detected and again when a release is detected and at the repeat rate (if enabled - see [Section 6.14](#) and [Section 6.34](#)).
- ‘1’ - An interrupt is generated when a press is detected and at the repeat rate (if enabled - see [Section 6.14](#) and [Section 6.34](#)).

6.35 Grouped Sensor Channel Enable Register

TABLE 6-51: GROUPED SENSOR CHANNEL ENABLE REGISTER

ADDR	R/W	Register	B7	B6	B5	B4	B3	B2	B1	B0	Default
41h	R/W	Grouped Sensor Channel Enable	-	CS14_EN	CS13_EN	CS12_EN	CS11_EN	CS10_EN	CS9_EN	CS8_EN	7Fh

The Grouped Sensor Channel Enable Register enables sensors within Grouped Sensors to be sampled during the polling cycle. This register may be updated at any time. If the grouped sensors are treated as a group (see [Section 6.34](#)), then disabling one or more sensors will cause the slider to behave erratically or not at all.

Bit 6 - CS14_EN - Enables the CS14 sensor to be sampled in the polling cycle.

Bit 5 - CS13_EN - Enables the CS13 sensor to be sampled in the polling cycle.

Bit 4 - CS12_EN - Enables the CS12 sensor to be sampled in the polling cycle.

Bit 3 - CS11_EN - Enables the CS11 sensor to be sampled in the polling cycle.

Bit 2 - CS10_EN - Enables the CS10 sensor to be sampled in the polling cycle.

Bit 1 - CS9_EN - Enables the CS9 sensor to be sampled in the polling cycle.

Bit 0 - CS8_EN - Enables the CS8 sensor to be sampled in the polling cycle.

6.36 Proximity Control Register

TABLE 6-52: PROXIMITY CONTROL REGISTER

ADDR	R/W	Register	B7	B6	B5	B4	B3	B2	B1	B0	Default
42h	R/W	Proximity Control	CS1_PROX	PROX_SUM	-	PROX_AVG [1:0]		PROX_D_SENSE[2:0]			02h

The Proximity Control Register controls sensitivity settings for CS1.

Bit 7 - CS1_PROX - Determines the functionality of the CS1 channel.

- ‘0’ (default) - The CS1 channel is not measuring proximity. It will use the standard button queue and data sensitivity controls. The Averaging will be set to a value of ‘1’. Writing to the PROX_AVG[2:0] bits will change the averaging applied to CS1 (and only CS1).
- ‘1’ - The CS1 channel is measuring proximity. It will not use the queue. In addition, the CS1 channel will not use the DELTA_SHIFT[2:0] sensitivity settings and will instead use the PROX_D_SHIFT[2:0] settings. In proximity mode, the signal is boosted by 8X to detect very small capacitance changes.

Bit 6 - PROX_SUM - Determines whether the CS1 channel averaging will perform an average or calculate the sum of the measured channel when comparing the delta count against the threshold.

‘0’ (default) - When configured to detect proximity, the CS1 channel delta counts will be the average.

‘1’ - When configured to detect proximity, the CS1 channel will sum the results of the averages rather than report the true average. This value will be compared against the threshold normally. Note that this mode is intended for very small signal detection. Because the delta count is the summation of several consecutive measurements, it may become very large. Adjustments to the sensitivity and threshold values will be required to maintain proper operation.

Bits 5 - 3 - PROX_AVG[1:0] - Determines the averaging value used when CS1 is set to detect proximity. When averaging is enabled (i.e. not set at a value of ‘1’), the CS1 sensor will be sampled the average number of times consecutively during the same polling cycle. The delta counts are summed and then divided by the number of averages to get an average delta which is compared against the threshold normally.

CAP1114

This will increase the time of the polling cycle linearly with the number of averages taken. As the polling cycle time is used to set the update rate, repeat rate, and recalibration times, these will likewise increase. See [Table 6-53](#).

TABLE 6-53: PROX_AVG BIT DECODE

PROX_AVG[1:0]		Number of Digital Averages	Polling Cycle Time Increase (See Note 6-4)
1	0		
0	0	16 (default)	+38.4ms
0	1	32	+79.36ms
1	0	64	+161.28ms
1	1	128	+325.12ms

Note 6-4 The Polling time increase is based on the default sampling time as determined by the Sampling Configuration register (see [Section 6.38](#)).

Bits 2 - 0 - PROX_D_SENSE[2:0] - Controls the sensitivity of proximity detection on CS1. The sensitivity settings act to scale the relative delta count value higher or lower based on the system parameters. A setting of 0000b is the most sensitive while a setting of 1111b is the least sensitive. At the more sensitive settings, touches are detected for a smaller delta C corresponding to a “lighter” touch. These settings are more sensitive to noise, however, and a noisy environment may flag more false touches than less sensitive levels. See [Table 6-17](#).

6.37 Sampling Channel Select Register

TABLE 6-54: SAMPLING CHANNEL SELECT REGISTER

ADDR	R/W	Register	B7	B6	B5	B4	B3	B2	B1	B0	Default
4Eh	R/W	Sampling Channel Select	GR_S	CS7_S	CS6_S	CS5_S	CS4_S	CS3_S	CS2_S	CS1_S	00h

The Sampling Channel Select Register determines which (if any) Capacitive Sensor input is controlled by the Sampling Configuration register.

Bit 7 - GR_S - Determines if all grouped sensors are controlled by the Sampling Configuration register settings.

- ‘0’ (default) - The grouped sensors are not controlled by the Sampling Configuration register settings. All Grouped sensors will be sampled in a 2.5ms window of the entire polling cycle (which requires 35ms).
- ‘1’ - The grouped sensors are controlled by the Sampling Configuration register settings. Each sensor sampling window will be determined based on these bit settings and the overall polling cycle time will increase.

Bit 6 - CS7_S - Determines if Capacitive Touch Sensor 7 is controlled by the Sampling Configuration register settings.

Bit 5 - CS6_S - Determines if Capacitive Touch Sensor 6 is controlled by the Sampling Configuration register settings.

Bit 4 - CS5_S - Determines if Capacitive Touch Sensor 5 is controlled by the Sampling Configuration register settings.

Bit 3 - CS4_S - Determines if Capacitive Touch Sensor 4 is controlled by the Sampling Configuration register settings.

Bit 2 - CS3_S - Determines if Capacitive Touch Sensor 3 is controlled by the Sampling Configuration register settings.

Bit 1 - CS2_S - Determines if Capacitive Touch Sensor 2 is controlled by the Sampling Configuration register settings.

Bit 0 - CS1_S - Determines if Capacitive Touch Sensor 1 is controlled by the Sampling Configuration register settings.

6.38 Sampling Configuration Register

TABLE 6-55: SAMPLING CONFIGURATION REGISTER

ADDR	R/W	Register	B7	B6	B5	B4	B3	B2	B1	B0	Default
4Fh	R/W	Sampling Configuration	-	-	-	-	-	OVERSAMP_RATE[2:0]			00h

The Sampling Configuration Register controls the length of the sampling window of selected Capacitive Touch Sensor channels as indicated in the Sampling Channel Select register.

Increasing the sampling window time will have two effects. The first effect will be to increase the effective sensitivity of that particular channel so that a touch may be detected with a smaller ΔC . However, at the larger sampling times, the resolution of the measurement is reduced.

The second effect will be increase the overall round robin rate (and all timing associated with the round robin rate such as re-calibration times, repeat rate times, and maximum duration times).

All Capacitive Touch Sensors default to a sampling time of 2.5ms. Increasing the sampling time of any single channel will increase the overall polling cycle by the same amount.

Bits 2 - 0 - OVERSAMP_RATE[2:0] - Determine the time to take a single sample. This setting applies to all selected sensors.

TABLE 6-56: OVERSAMP_RATE BIT DECODE

OVERSAMP_RATE[2:0]			Sensor Sampling Time
2	1	0	
1	0	0	40.96ms
1	0	1	20.48ms
1	1	0	10.24ms
1	1	1	5.12ms
0	0	0	2.56ms (default)
0	0	1	1.28ms
0	1	0	0.64ms
0	1	1	0.32ms

6.39 Sensor Base Count Registers

TABLE 6-57: SENSOR BASE COUNT REGISTERS

ADDR	R/W	Register	B7	B6	B5	B4	B3	B2	B1	B0	Default
50h	R	Sensor 1 Base Count	128	64	32	16	8	4	2	1	00h
51h	R	Sensor 2 Base Count	128	64	32	16	8	4	2	1	00h
52h	R	Sensor 3 Base Count	128	64	32	16	8	4	2	1	00h
53h	R	Sensor 4 Base Count	128	64	32	16	8	4	2	1	00h
54h	R	Sensor 5 Base Count	128	64	32	16	8	4	2	1	00h
55h	R	Sensor 6 Base Count	128	64	32	16	8	4	2	1	00h
56h	R	Sensor 7 Base Count	128	64	32	16	8	4	2	1	00h
57h	R	Sensor 8 Base Count	128	64	32	16	8	4	2	1	00h
58h	R	Sensor 9 Base Count	128	64	32	16	8	4	2	1	00h
59h	R	Sensor 10 Base Count	128	64	32	16	8	4	2	1	00h
5Ah	R	Sensor 11 Base Count	128	64	32	16	8	4	2	1	00h
5Bh	R	Sensor 12 Base Count	128	64	32	16	8	4	2	1	00h

TABLE 6-57: SENSOR BASE COUNT REGISTERS (CONTINUED)

ADDR	R/W	Register	B7	B6	B5	B4	B3	B2	B1	B0	Default
5Ch	R	Sensor 13 Base Count	128	64	32	16	8	4	2	1	00h
5Dh	R	Sensor 14 Base Count	128	64	32	16	8	4	2	1	00h

The Sensor Base Count Registers store the calibrated “Not Touched” input value from the Capacitive Touch Sensor inputs. These registers are periodically updated by the re-calibration routine.

The routine uses an internal adder to add the current count value for each reading to the sum of the previous readings until sample size has been reached. At this point, the upper 16 bits are taken and used as the Sensor Base Count. The internal adder is then reset and the re-calibration routine continues.

The data presented is determined by the BASE_SHIFT bits (see [Section 6.13](#)).

6.40 LED Status Registers

TABLE 6-58: LED STATUS REGISTERS

ADDR	R/W	Register	B7	B6	B5	B4	B3	B2	B1	B0	Default
60h	R	LED Status 1	LED8_DN	LED7_DN	LED6_DN	LED5_DN	LED4_DN	LED3_DN	LED2_DN	LED1_DN	00h
61h	R	LED Status 2	-	-	-	-	-	LED11_DN	LED10_DN	LED9_DN	00h

The LED Status Registers indicate which LED output has completed its actuated activity. The bits are cleared when the INT bit has been cleared. Likewise, these bits are cleared when the DSLEEP bit is set.

6.40.1 LED STATUS 1

Bit 7 - LED8_DN - Indicates that LED8 has finished its ramping behavior as determined by the LED8_CTL bits.

Bit 6 - LED7_DN - Indicates that LED7 has finished its ramping behavior as determined by the LED7_CTL bits.

Bit 5 - LED6_DN - Indicates that LED6 has finished its ramping behavior as determined by the LED6_CTL bits.

Bit 4 - LED5_DN - Indicates that LED5 has finished its ramping behavior as determined by the LED5_CTL bits.

Bit 3 - LED4_DN - Indicates that LED4 has finished its ramping behavior as determined by the LED4_CTL bits.

Bit 2 - LED3_DN - Indicates that LED3 has finished its ramping behavior as determined by the LED3_CTL bits.

Bit 1 - LED2_DN - Indicates that LED2 has finished its ramping behavior as determined by the LED2_CTL bits.

Bit 0 - LED1_DN - Indicates that LED1 has finished its ramping behavior as determined by the LED1_CTL bits.

6.40.2 LED STATUS 2

Bit 2 - LED11_DN - Indicates that LED11 has finished its ramping behavior as determined by the LED3_CTL bits.

Bit 1 - LED10_DN - Indicates that LED10 has finished its ramping behavior as determined by the LED2_CTL bits.

Bit 0 - LED9_DN - Indicates that LED9 has finished its ramping behavior as determined by the LED1_CTL bits.

6.41 LED / GPIO Direction Register

TABLE 6-59: LED / GPIO DIRECTION REGISTER

ADDR	R/W	Register	B7	B6	B5	B4	B3	B2	B1	B0	Default
70h	R/W	LED / GPIO Direction	LED8_DIR	LED7_DIR	LED6_DIR	LED5_DIR	LED4_DIR	LED3_DIR	LED2_DIR	LED1_DIR	00h

The LED / GPIO Direction Register controls the data flow direction for the LED / GPIO pins. Each pin is controlled by a single bit.

Bit 7 - LED8_DIR - Controls the direction of the LED8 / GPIO8 pin.

- '0' (default) - The LED8 / GPIO8 pin is configured as an input and cannot be used to drive an LED.
- '1' - The LED8 / GPIO8 pin is configured as an output.

Bit 6 - LED7_DIR - Controls the direction of the LED7 / GPIO7 pin.

Bit 5 - LED6_DIR - Controls the direction of the LED6 / GPIO6 pin.

Bit 4 - LED5_DIR - Controls the direction of the LED5 / GPIO5 pin.

Bit 3 - LED4_DIR - Controls the direction of the LED4 / GPIO4 pin.

Bit 2 - LED3_DIR - Controls the direction of the LED3 / GPIO3 pin.

Bit 1 - LED2_DIR - Controls the direction of the LED2 / GPIO2 pin.

Bit 0 - LED1_DIR - Controls the direction of the LED1 / GPIO1 pin.

6.42 LED / GPIO Output Type Register

TABLE 6-60: LED / GPIO OUTPUT TYPE REGISTER

ADDR	R/W	Register	B7	B6	B5	B4	B3	B2	B1	B0	Default
71h	R/W	LED / GPIO Output Type	LED8_OT	LED7_OT	LED6_OT	LED5_OT	LED4_OT	LED3_OT	LED2_OT	LED1_OT	00h

The LED / GPIO Output Type Register controls the type of output for the LEDx / GPIOx pins that are configured to operate as outputs. Each pin is controlled by a single bit.

Bit 7 - LED8_OT - Determines the output type of LED8.

- '0' (default) - The LED8 / GPIO8 pin is an open-drain output with an external pull-up resistor. When the appropriate bit is set to the "active" state (logic '1'), the pin will be driven low. Conversely, when the bit is set to the "inactive" state (logic '0'), the pin will be left in a high-Z state and pulled high via an external pull-up resistor.
- '1' - The LEDx / GPIO8 pin is a push-pull output. When driving a logic '1', the pin is driven high. When driving a logic '0', the pin is driven low.

Bit 6 - LED7_OT - Determines the output type of LED7.

Bit 5 - LED6_OT - Determines the output type of LED6.

Bit 4 - LED5_OT - Determines the output type of LED5.

Bit 3 - LED4_OT - Determines the output type of LED4.

Bit 2 - LED3_OT - Determines the output type of LED3.

Bit 1 - LED2_OT - Determines the output type of LED2.

Bit 0 - LED1_OT - Determines the output type of LED1.

6.43 GPIO Input Register

TABLE 6-61: GPIO INPUT REGISTER

ADDR	R/W	Register	B7	B6	B5	B4	B3	B2	B1	B0	Default
72h	R	GPIO Input	GPIO8	GPIO7	GPIO6	GPIO5	GPIO4	GPIO3	GPIO2	GPIO1	00h

The GPIO Input Register reflects the state of the LEDx / GPIOx pins. These bits are updated whenever the pin state changes regardless of the operation of the pin. If a LEDx / GPIOx pin is configured as an input (see [Section 6.41](#)), when a pin changes states, the GPIOx_STS bit is set. If the corresponding interrupt enable bit is also set, an interrupt will be asserted.

6.44 LED Output Control Registers

TABLE 6-62: LED OUTPUT CONTROL REGISTERS

ADDR	R/W	Register	B7	B6	B5	B4	B3	B2	B1	B0	Default
73h	R/W	LED Output Control 1	LED8_DR	LED7_DR	LED6_DR	LED5_DR	LED4_DR	LED3_DR	LED2_DR	LED1_DR	00h
74h	R/W	LED Output Control 2						LED11_DR	LED10_DR	LED9_DR	00h

The LED Output Control Registers control the output state of the LED pins when they are configured as outputs (see [Section 6.41, "LED / GPIO Direction Register"](#)). When these bits are set, the drive of the pin is determined by the output type and the polarity controls (see [Section 6.42, "LED / GPIO Output Type Register"](#) and [Section 6.45, "LED Polarity Registers"](#)).

The LED Polarity Control register will determine the non actuated state of the LED pins. The actuated LED behavior is determined by the LED behavior controls (see [Section 6.49](#)).

6.44.1 LED OUTPUT CONTROL 1

Bit 7 - LED8_DR - Determines whether the LED8 output is driven high or low. This LED cannot be linked to a Capacitive Touch Sensor.

- '0' (default) - The LED8 output is driven at the minimum duty cycle or is not actuated.
- '1' - The LED8 output is high-Z or driven at the maximum duty cycle or is actuated.

Bit 6 - LED7_DR - Determines whether LED7 output is driven high or low.

Bit 5 - LED6_DR - Determines whether LED6 output is driven high or low.

Bit 4 - LED5_DR - Determines whether LED5 output is driven high or low.

Bit 3 - LED4_DR - Determines whether LED4 output is driven high or low.

Bit 2 - LED3_DR - Determines whether LED3 output is driven high or low.

Bit 1 - LED2_DR - Determines whether LED2 output is driven high or low.

Bit 0 - LED1_DR - Determines whether LED1 output is driven high or low.

6.44.2 LED OUTPUT CONTROL 2

Bit 2 - LED11_DR - Determines whether LED11 is driven high or low. This LED cannot be linked to a Capacitive Touch Sensor.

- '0' (default) - The LED11 output is driven at the minimum duty cycle or is not actuated
- '1' - The LED11 output is high-Z or driven at the maximum duty cycle or is actuated.

Bit 1 - LED10_DR - Determines whether LED10 is driven high or low. If this LED is linked to the Group of sensors, LED9 is automatically linked to the Group if sensors.

Bit 0 - LED9_DR - Determines whether LED9 is driven high or low.

6.45 LED Polarity Registers

TABLE 6-63: LED POLARITY REGISTERS

ADDR	R/W	Register	B7	B6	B5	B4	B3	B2	B1	B0	Default
75h	R/W	LED Polarity 1	LED8_POL	LED7_POL	LED6_POL	LED5_POL	LED4_POL	LED3_POL	LED2_POL	LED1_POL	00h
76h	R/W	LED Polarity 2	-	-	-	-	-	LED11_POL	LED10_POL	LED9_POL	00h

The LED Polarity Registers control the logical polarity of the LED outputs. When these bits are set or cleared, the corresponding LED Mirror controls are also set or cleared (unless the BLK_POL_MIR bit is set - see [Section 6.34](#)). [Table 6-64, "LED Polarity Behavior"](#) shows the interaction between the polarity controls, output controls, and relative brightness.

APPLICATION NOTE: The polarity controls determine the final LED pin drive. A touch on a linked Capacitive Touch Sensor is treated in the same way as the LED Output Control bit being set to a logic '1'.

APPLICATION NOTE: The LED drive assumes that the LEDs are configured such that if the LED pin is driven to a logic '0', the LED will be on and the CAP1114 LED pin is sinking the LED current. Conversely, if the LED pin is driven to a logic '1', the LED will be off and there is no current flow. See Figure 5-1, "System Diagram for CAP1114".

APPLICATION NOTE: This application note applies when the LED polarity is inverted (LEDx_POL = '0'). For LED operation, the duty cycle settings determine the % of time that the LED pin will be driven to a logic '0' state in an inverted system. The Max Duty Cycle settings define the maximum % of time that the LED pin will be driven low (i.e. maximum % of time that the LED is **on**) while the Min Duty Cycle settings determine the minimum % of time that the LED pin will be driven low (i.e. minimum % of time that the LED is **on**). When there is no touch detected or the LED Output Control register bit is at a logic '0', the LED output will be driven at the minimum duty cycle setting. Breathe operations will ramp the duty cycle from the minimum duty cycle to the maximum duty cycle.

APPLICATION NOTE: This application note applies when the LED polarity is non-inverted (LEDx_POL = '1'). For LED operation, the duty cycle settings determine the % of time that the LED pin will be driven to a logic '1' state in a non-inverted system. The Max Duty Cycle settings define the maximum % of time that the LED pin will be driven high (i.e. maximum % of time that the LED is **off**) while the Min Duty Cycle settings determine the minimum % of time that the LED pin will be driven high (i.e. minimum % of time that the LED is **off**). When there is no touch detected or the LED Output Control register bit is at a logic '0', the LED output will be driven at 100 minus the minimum duty cycle setting. Breathe operations will ramp the duty cycle from 100 minus the minimum duty cycle to 100 minus the maximum duty cycle.

APPLICATION NOTE: The LED Mirror controls (see [Section 6.47, "LED Mirror Control"](#)) work with the polarity controls with respect to LED brightness but will not have a direct effect on the output pin drive.

TABLE 6-64: LED POLARITY BEHAVIOR

LED Output Control Register	Polarity	MAX Duty	MIN Duty	Brightness	LED Appearance
0	inverted ('0')	not used	minimum % of time that the LED is on (logic 0)	maximum brightness at min duty cycle	on at min duty cycle
1	inverted ('0')	maximum % of time that the LED is on (logic 0)	minimum % of time that the LED is on (logic 0)	maximum brightness at max duty cycle. Brightness ramps from min duty cycle to max duty cycle.	according to LED behavior
0	non-inverted ('1')	not used	minimum % of time that the LED is off (logic 1)	maximum brightness at 100 minus min duty cycle	on at 100 - min duty cycle
1	non-inverted ('1')	maximum % of time that the LED is off (logic 1)	minimum % of time that the LED is off (logic 1)	For Direct behavior, maximum brightness is 100 minus max duty cycle. When breathing, max brightness is 100 minus min duty cycle. Brightness ramps from 100 - min duty cycle to 100 - max duty cycle.	according to LED behavior

6.45.1 LED POLARITY 1

Bit 7 - LED8_POL - Determines the polarity of the LED8 output.

- '0' - The LED8 output is inverted. For example, a setting of '1' in the LED 8 Output register will cause the LED pin output to be driven to a logic '0'.
- '1' - The LED8 output is non-inverted. For example, a setting of '1' in the LED 8 Output register will cause the LED pin output to be driven to a logic '1' or left in the high-Z state as determined by its output type.

Bit 6 - LED7_POL - Determines the polarity of the LED7 output.

Bit 5 - LED6_POL - Determines the polarity of the LED6 output.

Bit 4 - LED5_POL - Determines the polarity of the LED5 output.

Bit 3 - LED4_POL - Determines the polarity of the LED4 output.

Bit 2 - LED3_POL - Determines the polarity of the LED3 output.

Bit 1 - LED2_POL - Determines the polarity of the LED2 output.

Bit 0 - LED1_POL - Determines the polarity of the LED1 output.

6.45.2 LED POLARITY 2

Bit 2 - LED11_POL - Determines the polarity of the LED11 output.

Bit 1 - LED10_POL - Determines the polarity of the LED10 output.

Bit 0 - LED9_POL - Determines the polarity of the LED9 output.

6.46 Linked LED Transition Control Registers

TABLE 6-65: LINKED LED TRANSITION CONTROL REGISTERS

ADDR	R/W	Register	B7	B6	B5	B4	B3	B2	B1	B0	Default
77h	R/W	Linked LED Transition Control 1	-	LED7_LTRAN	LED6_LTRAN	LED5_LTRAN	LED4_LTRAN	LED3_LTRAN	LED2_LTRAN	LED1_LTRAN	00h
78h	R/W	Linked LED Transition Control 2	-	-	-	-	-	-	LED10_LTRAN	LED9_LTRAN	00h

The Linked LED Transition Control Registers control the LED drive when the LED is linked to a Capacitive Touch sensor. These controls work in conjunction INV_LINK_TRAN bit (see [Section 6.34, "Configuration 2 Register"](#)) to create smooth transitions from host control to linked LEDs.

6.46.1 LINKED LED TRANSITION CONTROL 1 - 77H

Bit 6 - LED7_LTRAN - Determines the transition effect when LED7 is linked to CS7.

- '0' (default) - When the LED output control bit for CS7 is '1', and then CS7 is linked to LED7 and no touch is detected, the LED will change states.
- '1' - If the INV_LINK_TRAN bit is '1', when the LED output control bit for CS7 is '1', and then CS7 is linked to LED7 and no touch is detected, the LED will not change states. In addition, the LED state will change when the sensor is touched. If the INV_LINK_TRAN bit is '0', when the LED output control bit for CS7 is '1', and then CS7 is linked to LED7 and no touch is detected, the LED will not change states. However, the LED state will not change when the sensor is touched.

APPLICATION NOTE: If the LED behavior is not "Direct" and the INV_LINK_TRAN bit is '0', the LED will not perform as expected when the LED7_LTRAN bit is set to '1'. Therefore, if breathe and pulse behaviors are used, set the INV_LINK_TRAN bit to '1'.

Bit 5 - LED6_LTRAN - Determines the transition effect when LED6 is linked to CS6.

Bit 4 - LED5_LTRAN - Determines the transition effect when LED5 is linked to CS5.

Bit 3 - LED4_LTRAN - Determines the transition effect when LED4 is linked to CS4.

Bit 2 - LED3_LTRAN - Determines the transition effect when LED3 is linked to CS3.

Bit 1 - LED2_LTRAN - Determines the transition effect when LED2 is linked to CS2.

Bit 0 - LED1_LTRAN - Determines the transition effect when LED1 is linked to CS1.

6.46.2 LINKED LED TRANSITION CONTROL 2 - 78H

Bit 1 - LED10_LTRAN - Determines the transition effect when LED10 is linked to the Grouped Sensors.

Bit 0 - LED9_LTRAN - Determines the transition effect when LED9 is linked to the Grouped Sensors.

6.47 LED Mirror Control

TABLE 6-66: LED MIRROR CONTROL REGISTERS

ADDR	R/W	Register	B7	B6	B5	B4	B3	B2	B1	B0	Default
79h	R/W	LED Mirror Control 1	LED8_MIR_EN	LED7_MIR_EN	LED6_MIR_EN	LED5_MIR_EN	LED4_MIR_EN	LED3_MIR_EN	LED2_MIR_EN	LED1_MIR_EN	00h
7Ah	R/W	LED Mirror Control 2	-	-	-	-	-	LED11_MIR_EN	LED10_MIR_EN	LED9_MIR_EN	00h

The LED Mirror Control Registers determine the meaning of duty cycle settings when polarity is non-inverted for each LED channel. When the polarity bit is set to '1' (non-inverted), to obtain correct steps for LED ramping, pulse, and breathe behaviors, the min and max duty cycles need to be relative to 100%, rather than the default, which is relative to 0%.

APPLICATION NOTE: The LED drive assumes that the LEDs are configured such that if the LED pin is driven to a logic '0', the LED will be on and the CAP1114 LED pin is sinking the LED current. When the polarity bit is set to '1', it is considered non-inverted. For systems using the opposite LED configuration, mirror controls would apply when the polarity bit is '0'.

These bits are changed automatically if the corresponding LED Polarity bit is changed (unless the BLK_POL_MIR bit is set - see [Section 6.34](#)).

6.47.1 LED MIRROR CONTROL 1 - 79H

Bit 7 - LED8_MIR_EN - Determines whether the duty cycle settings are "biased" relative to 0% or 100% duty cycle.

- '0' (default) - The duty cycle settings are determined relative to 0% and are determined directly with the settings.
- '1' - The duty cycle settings are determined relative to 100%.

Bit 6 - LED7_MIR_EN - Determines whether the duty cycle settings are "biased" relative to 0% or 100% duty cycle.

Bit 5 - LED6_MIR_EN - Determines whether the duty cycle settings are "biased" relative to 0% or 100% duty cycle.

Bit 4 - LED5_MIR_EN - Determines whether the duty cycle settings are "biased" relative to 0% or 100% duty cycle.

Bit 3 - LED4_MIR_EN - Determines whether the duty cycle settings are "biased" relative to 0% or 100% duty cycle.

Bit 2 - LED3_MIR_EN - Determines whether the duty cycle settings are "biased" relative to 0% or 100% duty cycle.

Bit 1 - LED2_MIR_EN - Determines whether the duty cycle settings are "biased" relative to 0% or 100% duty cycle.

Bit 0 - LED1_MIR_EN - Determines whether the duty cycle settings are "biased" relative to 0% or 100% duty cycle.

6.47.2 LED MIRROR CONTROL 2 - 7AH

Bit 2 - LED11_MIR_EN - Determines whether the duty cycle settings are "biased" relative to 0% or 100% duty cycle.

Bit 1 - LED10_MIR_EN - Determines whether the duty cycle settings are "biased" relative to 0% or 100% duty cycle.

Bit 0 - LED9_MIR_EN - Determines whether the duty cycle settings are "biased" relative to 0% or 100% duty cycle.

6.48 Sensor LED Linking Register

TABLE 6-67: SENSOR LED LINKING REGISTER

ADDR	R/W	Register	B7	B6	B5	B4	B3	B2	B1	B0	Default
80h	R/W	Sensor LED Linking	UP_DOWN_LINK	CS7_LED7	CS6_LED6	CS5_LED5	CS4_LED4	CS3_LED3	CS2_LED2	CS1_LED1	00h

The Sensor LED Linking Register controls whether a Capacitive Touch Sensor is linked to an LED output or not. If the corresponding bit is set, the appropriate LED output will change states defined by the LED Behavior controls (see [Section 6.49](#)) in response to the Capacitive Touch sensor.

If the LED channel is configured as an input, the corresponding Sensor LED Linking bit is ignored.

Bit 7 - UP_DOWN_LINK - Links the LED10 output to a detected UP condition on the group including a slide in the “up” direction, a tap on the “up” side of the group or a press and hold condition on the “up” side of the group. The LED10 driver will be actuated and will behave as determined by the LED10_CTL bits. This bit also links the LED9 output to a detected DOWN condition on the group including a slide in the “down” direction, a tap on the “down” side of the group or a press and hold condition on the “down” side of the group. The LED9 driver will be actuated and will behave as determined by the LED9_CTL bits.

LED9 and LED10 will not be active simultaneously. If LED9 is actuated by detecting a slide, tap, or press and hold event, LED10 will be inactive. Likewise, if LED10 is actuated by detecting a slide, tap, or press and hold event, LED9 will be inactive.

Bit 6 - CS7_LED7 - Links the LED7 output to a detected touch on the CS7 sensor. When a touch is detected, the LED is actuated and will behave as determined by the LED Behavior controls.

- ‘0’ - The LED7 output is not associated with the CS7 input. If a touch is detected on the CS7 input, the LED will not automatically be actuated. The LED is enabled and controlled via the LED Output Configuration register (see [Section 6.44](#)) and the LED Behavior registers (see [Section 6.49](#)).
- ‘1’ - The LED 7 output is associated with the CS7 input. If a touch is detected on the CS7 input, the LED will be actuated and behave as defined in [Table 6-69](#). Furthermore, the LED will automatically be enabled.

Bit 5 - CS6_LED6 - Links the LED6 output to a detected touch on the CS6 sensor. When a touch is detected, the LED is actuated and will behave as determined by the LED Behavior controls.

Bit 4 - CS5_LED5 - Links the LED5 output to a detected touch on the CS5 sensor. When a touch is detected, the LED is actuated and will behave as determined by the LED Behavior controls.

Bit 4 - CS4_LED4 - Links the LED4 output to a detected touch on the CS4 sensor. When a touch is detected, the LED is actuated and will behave as determined by the LED Behavior controls.

Bit 2 - CS3_LED3 - Links the LED3 output to a detected touch on the CS3 sensor. When a touch is detected, the LED is actuated and will behave as determined by the LED Behavior controls.

Bit 1 - CS2_LED2 - Links the LED2 output to a detected touch on the CS2 sensor. When a touch is detected, the LED is actuated and will behave as determined by the LED Behavior controls.

Bit 0 - CS1_LED1 - Links the LED1 output to a detected touch on the CS1 sensor. When a touch is detected, the LED is actuated and will behave as determined by the LED Behavior controls.

6.49 LED Behavior Registers

TABLE 6-68: LED BEHAVIOR REGISTERS

ADDR	R/W	Register	B7	B6	B5	B4	B3	B2	B1	B0	Default
81h	R/W	LED Behavior 1	LED4_CTL[1:0]	LED3_CTL[1:0]	LED2_CTL[1:0]	LED1_CTL[1:0]					00h
82h	R/W	LED Behavior 2	LED8_CTL[1:0]	LED7_CTL[1:0]	LED6_CTL[1:0]	LED5_CTL[1:0]					00h
83h	R/W	LED Behavior 3	LED11_ALT [1:0]	LED11_CTL [1:0]	LED10_CTL [1:0]	LED9_CTL[1:0]					00h

The LED Behavior Registers control the operation of LEDs. Each LEDx / GPIOx pin is controlled by a 2-bit field. If the LEDx / GPIOx pin is configured as an input, these bits are ignored.

If the corresponding LED output is linked to a Capacitive Touch Sensor, the appropriate behavior will be enabled / disabled based on touches and releases.

If the LED output is not associated with a Capacitive Touch Sensor, the appropriate behavior will be enabled / disabled by the LED Output Control register. If the respective LEDx_DR bit is set to a logic '1', this will be associated as a "touch", and if the LEDx_DR bit is set to a logic '0', this will be associated as a "release".

Table 6-69 shows the behavior triggers. The defined behavior will activate when the Start Trigger is met and will stop when the Stop Trigger is met. Note the behavior of the Breathe Hold and Pulse Release option.

The LED Polarity Control register will determine the non actuated state of the LED outputs (see Section 6.45, "LED Polarity Registers").

APPLICATION NOTE: If an LED is not linked to a Capacitive Touch Sensor and is breathing (via the Breathe or Pulse behaviors), it must be unactuated before any changes to behavior are processed.

APPLICATION NOTE: If an LED is not linked to the Capacitive Touch Sensor and configured to operate using Pulse 1 Behavior, the circuitry will only be actuated when the corresponding bit is set. It will not check the bit condition until the Pulse 1 behavior is finished. The device will not remember if the bit was cleared and reset while it was actuated.

APPLICATION NOTE: If an LED is actuated and it is switched from linked to a Capacitive Touch Sensor to unlinked (or vice versa), the LED will respond to the new command source immediately if the behavior was Direct or Breathe. For Pulse behaviors, it will complete the behavior already in progress. For example, if a linked LED was actuated by a touch and the control is changed so that it is unlinked, it will check the status of the corresponding LED Output Control bit. If that bit is '0', the LED will behave as if a release was detected. Likewise, if an unlinked LED was actuated by the LED Output Control register and the control is changed so that it is linked and no touch is detected, the LED will behave as if a release was detected.

6.49.1 LED BEHAVIOR 1 - 81H

Bits 7 - 6 - LED4_CTL[1:0] - Determines the behavior of LED4 / GPIO4 when configured to operate as an LED output.

Bits 5 - 4 - LED3_CTL[1:0] - Determines the behavior of LED3 / GPIO3 when configured to operate as an LED output.

Bits 3 - 2 - LED2_CTL[1:0] - Determines the behavior of LED2 / GPIO2 when configured to operate as an LED output.

Bits 1 - 0 - LED1_CTL[1:0] - Determines the behavior of LED1 / GPIO1 when configured to operate as an LED output.

6.49.2 LED BEHAVIOR 2 - 82H

Bits 7 - 6 - LED8_CTL[1:0] - Determines the behavior of LED8 / GPIO8 when configured to operate as an LED output.

Bits 5 - 4 - LED7_CTL[1:0] - Determines the behavior of LED7 / GPIO7 when configured to operate as an LED output.

Bits 3 - 2 - LED6_CTL[1:0] - Determines the behavior of LED6 / GPIO6 when configured to operate as an LED output.

Bits 1 - 0 - LED5_CTL[1:0] - Determines the behavior of LED5 / GPIO5 when configured to operate as an LED output.

6.49.3 LED BEHAVIOR 3 - 83H

Bits 7 - 6 - LED11_ALT[1:0] - Determines the behavior of LED 11 when the PWR_LED bit is set and either the SLEEP or DSLEEP bits are set (see Section 6.1).

Bits 5 - 4 - LED11_CTL[1:0] - Determines the behavior of LED11 when the PWR_LED bit is set and both the SLEEP and DSLEEP bits are not set (see Section 6.1).

Bits 3 - 2 - LED10_CTL[1:0] - Determines the behavior of LED10.

Bits 1 - 0 - LED9_CTL[1:0] - Determines the behavior of LED9.

APPLICATION NOTE: When driving the LED / GPIOx output as a GPO, the LEDx_CTL[1:0] bits should be set to 00b.

TABLE 6-69: LEDX_CTL BIT DECODE

LEDX_CTL [1:0]		Operation	Description	Start Trigger	Stop Trigger
1	0				
0	0	Direct	The LED is driven to the programmed state (active or inactive). See Figure 6-5 .	Touch Detected or LED Output Control bit set	Release Detected or LED Output Control bit cleared
0	1	Pulse 1	The LED will “Pulse” a programmed number of times. During each “Pulse” the LED will breathe up to the maximum brightness and back down to the minimum brightness so that the total “Pulse” period matches the programmed value.	Touch or Release Detected or LED Output Control bit set or cleared (see Section 6.50)	n/a
1	0	Pulse 2	The LED will “Pulse” when the start trigger is detected. When the stop trigger is detected, it will “Pulse” a programmable number of times then return to its minimum brightness.	Touch Detected or LED Output Control bit set	Release Detected or LED Output Control bit cleared
1	1	Breathe	The LED will breathe. It will be driven with a duty cycle that ramps up from the programmed minimum duty cycle (default 0%) to the programmed maximum duty cycle (default 100%) and then back down. Each ramp takes up 50% of the programmed period. The total period of each “breath” is determined by the LED Breathe Period controls - see Section 6.52 .	Touch Detected or LED Output Control bit set	Release Detected or LED Control Output bit cleared

APPLICATION NOTE: The PWM frequency is determined based on the selected LED behavior, the programmed breathe period, and the programmed min and max duty cycles. For the Direct behavior mode, the PWM frequency is calculated based on the programmed Rise and Fall times. If these are set at 0, the maximum PWM frequency will be used based on the programmed duty cycle settings.

6.50 LED Pulse 1 Period Register

TABLE 6-70: LED PULSE 1 PERIOD REGISTER

ADDR	R/W	Register	B7	B6	B5	B4	B3	B2	B1	B0	Default
84h	R/W	LED Pulse 1 Period	ST_TRIG	P1_PER6	P1_PER5	P1_PER4	P1_PER3	P1_PER2	P1_PER1	P1_PER0	20h

The LED Pulse 1 Period Register determines the overall period of a pulse operation as determined by the LED_CTL registers (see [Table 6-69](#) - setting 01b). Each LSB represents 32ms so that a setting of 14h (20d) would represent a period of 640ms. The total range is from 32ms to 4.06 seconds as shown in [Table 6-71](#).

The number of pulses is programmable as determined by the PULSE1_CNT bits (see [Section 6.53](#)).

Bit 7 - ST_TRIG - Determines the start trigger for the LED Pulse behavior.

- ‘0’ (default) - The LED will Pulse when a touch is detected or the drive bit is set.
- ‘1’ - The LED will Pulse when a release is detected or the drive bit is cleared.

The Pulse 1 operation is shown in [Figure 6-1](#) (non-inverted polarity LEDx_POL = 1) and [Figure 6-2](#) (inverted polarity LEDx_POL = 0).

FIGURE 6-1: PULSE 1 BEHAVIOR WITH TOUCH TRIGGER AND NON-INVERTED POLARITY

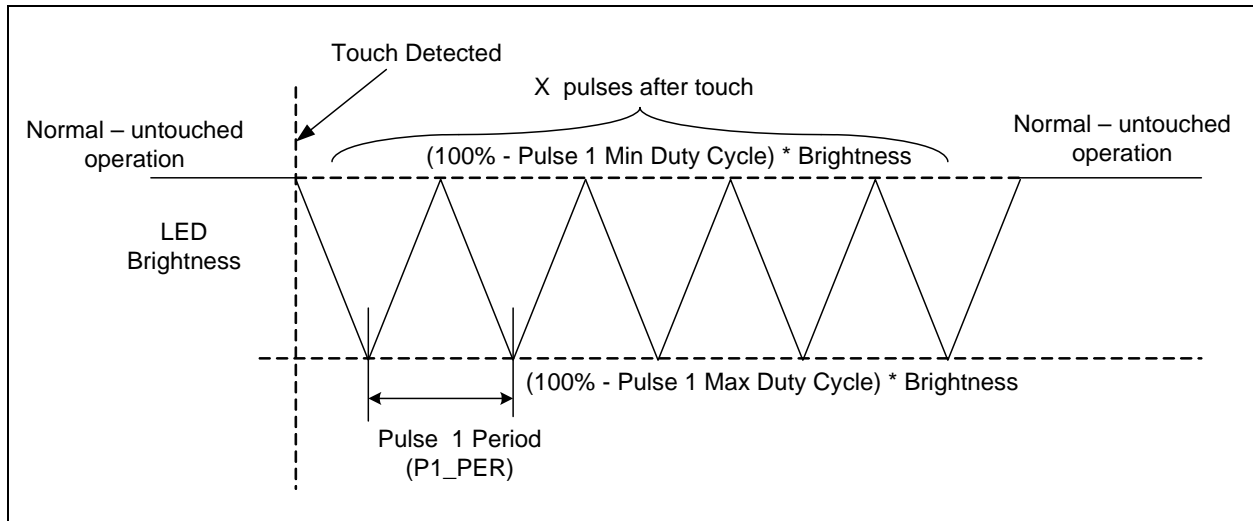

FIGURE 6-2: PULSE 1 BEHAVIOR WITH TOUCH TRIGGER AND INVERTED POLARITY

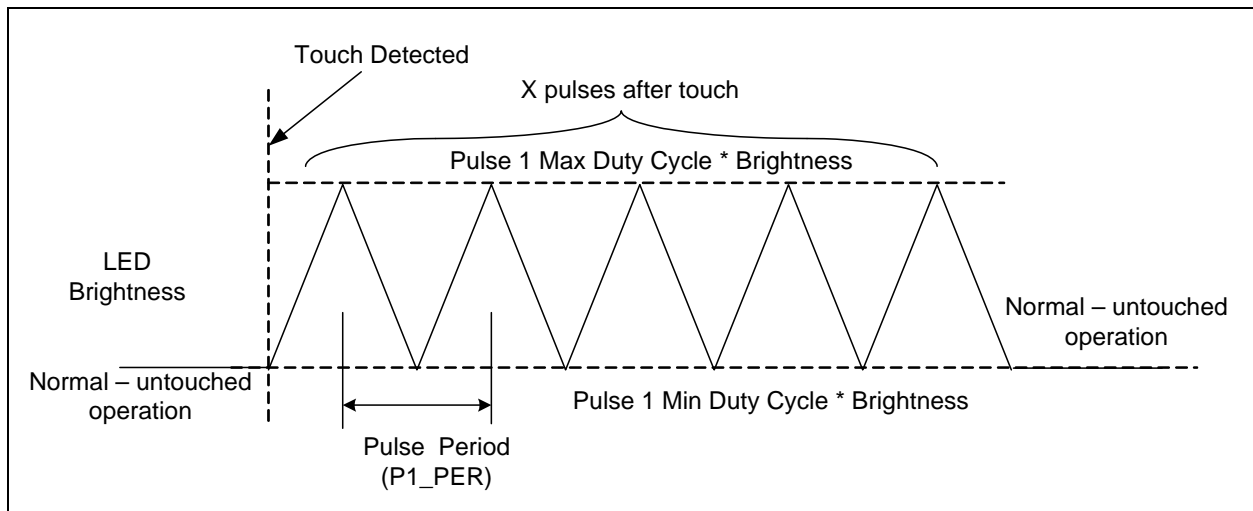

TABLE 6-71: LED PULSE / BREATHE PERIOD EXAMPLE

Setting (HEX)	Setting (Decimal)	Total Pulse / Breathe Period (ms)
00h	0	32
01h	1	32
02h	2	64
03h	3	96
04h	4	128
...
7Ch	124	3,968
7Dh	125	4,000
7Eh	126	4,032
7Fh	127	4,064

6.51 LED Pulse 2 Period Register

TABLE 6-72: LED PULSE 2 PERIOD REGISTER

ADDR	R/W	Register	B7	B6	B5	B4	B3	B2	B1	B0	Default
85h	R/W	LED Pulse 2 Period	-	P2_PER6	P2_PER5	P2_PER4	P2_PER3	P2_PER2	P2_PER1	P2_PER0	14h

The LED Pulse 2 Period Register determines the overall period of a pulse operation as determined by the LED_CTL registers (see [Table 6-69](#) - setting 10b). Each LSB represents 32ms so that a setting of 14h (20d) would represent a period of 640ms. The total range is from 32ms to 4.06 seconds (see [Table 6-71](#)).

The number of pulses is programmable as determined by the PULSE2_CNT bits (see [Section 6.53](#)).

The Pulse 2 Behavior is shown in [Figure 6-3](#) (non-inverted polarity LEDx_POL = 1) and [Figure 6-4](#) (inverted polarity LEDx_POL = 0).

FIGURE 6-3: PULSE 2 BEHAVIOR WITH NON-INVERTED POLARITY

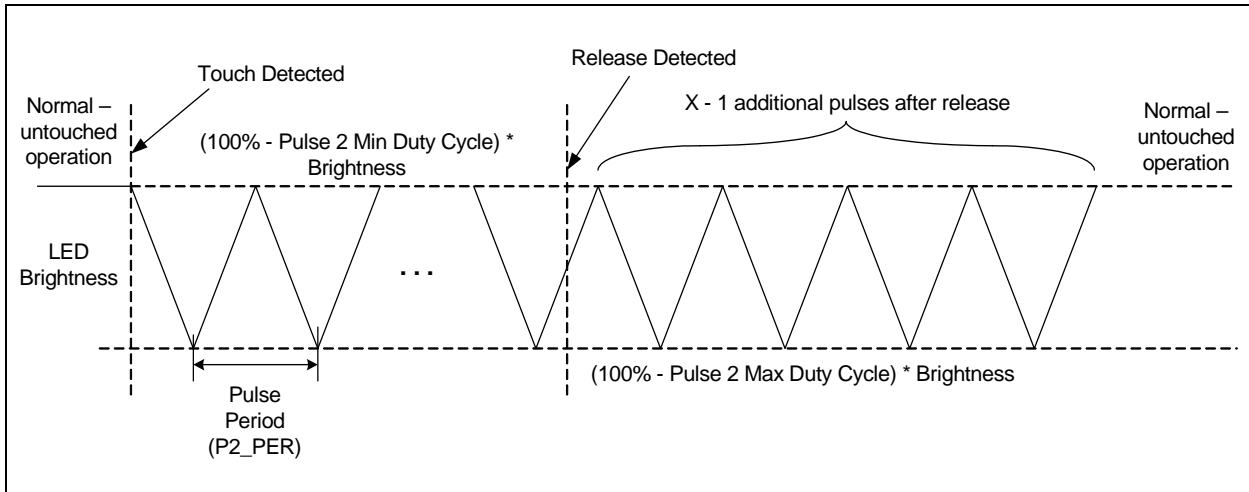
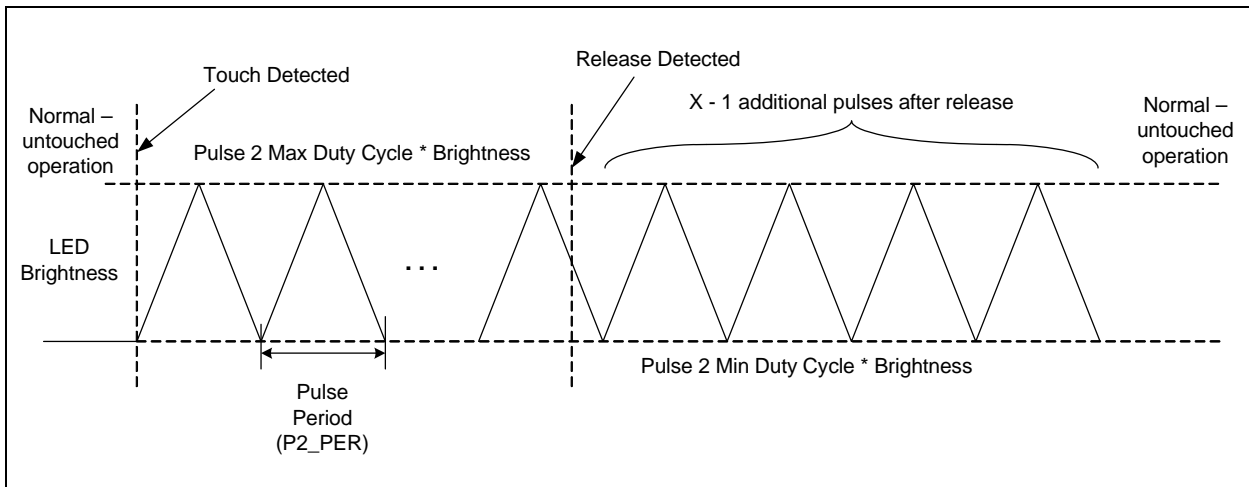

FIGURE 6-4: PULSE 2 BEHAVIOR WITH INVERTED POLARITY



6.52 LED Breathe Period Register

TABLE 6-73: LED BREATHE PERIOD REGISTER

ADDR	R/W	Register	B7	B6	B5	B4	B3	B2	B1	B0	Default
86h	R/W	LED Breathe Period	-	BR_PER6	BR_PER5	BR_PER4	BR_PER3	BR_PER2	BR_PER1	BR_PER0	5Dh

The LED Breathe Period Register determines the overall period of a breathe operation as determined by the LED_CTL registers (see [Table 6-69](#) - setting 11b). Each LSB represents 32ms so that a setting of 14h (20d) would represent a period of 640ms. The total range is from 32ms to 4.06 seconds (see [Table 6-71](#)).

6.53 LED Configuration Register

TABLE 6-74: LED CONFIGURATION REGISTERS

ADDR	R/W	Register	B7	B6	B5	B4	B3	B2	B1	B0	Default
88h	R/W	LED Config	-	RAMP_ALERT	PULSE2_CNT[2:0]			PULSE1_CNT[2:0]			24h

The LED Configuration Register controls the number of pulses that are sent for the Pulse 1 and Pulse 2 LED output behaviors.

Bit 6 - RAMP_ALERT - Determines whether the device will assert the ALERT pin when LEDs actuated by the LED Output Control register bits have finished their respective behaviors.

- '0' (default) - The ALERT pin will not be asserted when LEDs actuated by the LED Output Control register have finished their programmed behaviors.
- '1' - The ALERT pin will be asserted whenever any LED that is actuated by the LED Output Control register has finished its programmed behavior. If the DSLEEP bit is set, this bit is cleared.

Bits 5 - 3 - PULSE2_CNT[2:0] - Determines the number of pulses used for the Pulse 2 behavior as shown in [Table 6-75](#). The default is 100b.

Bits 2 - 0 - PULSE1_CNT[2:0] - Determines the number of pulses used for the Pulse 1 behavior as shown in [Table 6-75](#).

TABLE 6-75: PULSE_CNT DECODE

PULSEX_CNT[2:0]			Number of Breaths
2	1	0	
0	0	0	1
0	0	1	2
0	1	0	3
0	1	1	4
1	0	0	5 (default)
1	0	1	6
1	1	0	7
1	1	1	8

6.54 LED Pulse and Breathe Duty Cycle Registers

TABLE 6-76: LED PERIOD AND BREATHE DUTY CYCLE REGISTERS

ADDR	R/W	Register	B7	B6	B4	B4	B3	B2	B1	B0	Default
90h	R/W	LED Pulse 1 Duty Cycle	LED_P1_MAX_DUTY[3:0]				LED_P1_MIN_DUTY[3:0]				F0h
91h	R/W	LED Pulse 2 Duty cycle	LED_P2_MAX_DUTY[3:0]				LED_P2_MIN_DUTY[3:0]				F0h

CAP1114

TABLE 6-76: LED PERIOD AND BREATHE DUTY CYCLE REGISTERS (CONTINUED)

ADDR	R/W	Register	B7	B6	B4	B4	B3	B2	B1	B0	Default
92h	R/W	LED Breathe Duty Cycle	LED_BR_MAX_DUTY[3:0]				LED_BR_MIN_DUTY[3:0]				F0h
93h	R/W	Direct Duty Cycle	LED_DR_MAX_DUTY[3:0]				LED_DR_MIN_DUTY[3:0]				F0h

The LED Pulse and Breathe Duty Cycle Registers determine the minimum and maximum duty cycle settings used for the LED for each LED behavior. These settings affect the brightness of the LED when it is fully off and fully on.

The LED driver duty cycle will ramp up from the minimum duty cycle to the maximum duty cycle and back down again.

APPLICATION NOTE: When operating in Direct behavior mode, changes to the Duty Cycle settings will be applied immediately. When operating in Breathe, Pulse 1, or Pulse 2 modes, the LED must be unactuated and then re-actuated before changes to behavior are processed.

Bits 7 - 4 - LED_X_MAX_DUTY[3:0] - Determines the maximum PWM duty cycle for the LED drivers as shown in [Table 6-77](#).

Bits 3 - 0 - LED_X_MIN_DUTY[3:0] - Determines the minimum PWM duty cycle for the LED drivers as shown in [Table 6-77](#).

TABLE 6-77: LED DUTY CYCLE DECODE

X_MAX/MIN_DUTY [3:0]				Maximum Duty Cycle	Minimum Duty Cycle
3	2	1	0		
0	0	0	0	7%	0%
0	0	0	1	9%	7%
0	0	1	0	11%	9%
0	0	1	1	14%	11%
0	1	0	0	17%	14%
0	1	0	1	20%	17%
0	1	1	0	23%	20%
0	1	1	1	26%	23%
1	0	0	0	30%	26%
1	0	0	1	35%	30%
1	0	1	0	40%	35%
1	0	1	1	46%	40%
1	1	0	0	53%	46%
1	1	0	1	63%	53%
1	1	1	0	77%	63%
1	1	1	1	100%	77%

6.55 LED Direct Ramp Rates Register

TABLE 6-78: LED DIRECT RAMP RATES REGISTER

ADDR	R/W	Register	B7	B6	B5	B4	B3	B2	B1	B0	Default
94h	R/W	LED Direct Ramp Rates	-	-	RISE_RATE[2:0]			FALL_RATE[2:0]			00h

The LED Direct Ramp Rates Register control the rising and falling edge time of an LED that is configured to operate in Direct behavior mode. The rising edge time corresponds to the amount of time the LED takes to transition from its minimum duty cycle to its maximum duty cycle. Conversely, the falling edge time corresponds to the amount of time that the LED takes to transition from its maximum duty cycle to its minimum duty cycle.

Bits 5 - 3 - RISE_RATE[2:0] - Determines the rising edge time of an LED when it transitions from its minimum drive state to its maximum drive state as shown in [Table 6-79](#).

APPLICATION NOTE: If a non-zero fall time is desired, the rise rate must be set to be equal to the desired fall rate. This should be done as a register write after the LED has been actuated and before it is unactuated.

Bits 2 - 0 - FALL_RATE[2:0] - Determines the falling edge time of an LED when it transitions from its maximum drive state to its minimum drive state as shown in [Table 6-79](#).

TABLE 6-79: RISE / FALL RATE CYCLE DECODE

RISE/FALL_RATE [2:0]			Rise / Fall Time (T _{RISE} / T _{FALL})
2	1	0	
0	0	0	0
0	0	1	250ms
0	1	0	500ms
0	1	1	750ms
1	0	0	1s
1	0	1	1.25s
1	1	0	1.5s
1	1	1	2s

6.56 LED Off Delay Register

TABLE 6-80: LED OFF DELAY REGISTER

ADDR	R/W	Register	B7	B6	B5	B4	B3	B2	B1	B0	Default
95h	R/W	LED Off Delay Register	-	-	-	-	-	DIR_OFF_DLY [2:0]			00h

The LED Off Delay Register determines the amount of time an LED in Direct behavior mode remains active after it is no longer actuated (such as after a release has been detected or the drive state has been changed).

Bits 2 - 0 - DIR_OFF_DLY[2:0] - Determines the turn-off delay, as shown in [Table 6-81](#), for all LEDs that are configured to operate in Direct behavior mode.

TABLE 6-81: OFF DELAY SETTINGS

DIR_OFF_DLY [2:0]			Off Delay T _{OFF_DLY}
2	1	0	
0	0	0	0
0	0	1	0.5s
0	1	0	1.0s
0	1	1	1.5s
1	0	0	2.0s
1	0	1	3.0s
1	1	0	4.0s
1	1	1	5.0s

The Direct behavior operation is shown determined by the combination of programmed Rise Time, Fall Time, and Off Delay as shown in [Table 6-5](#) (non-inverted polarity LED_x_POL = 1) and [Figure 6-6](#) (inverted polarity LED_x_POL = 0).

FIGURE 6-5: DIRECT BEHAVIOR FOR NON-INVERTED POLARITY

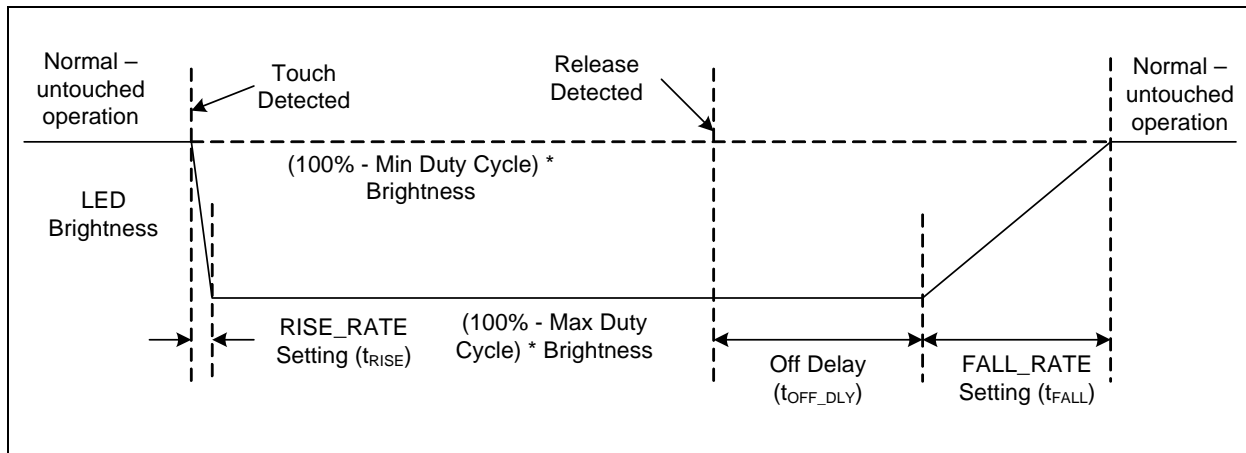
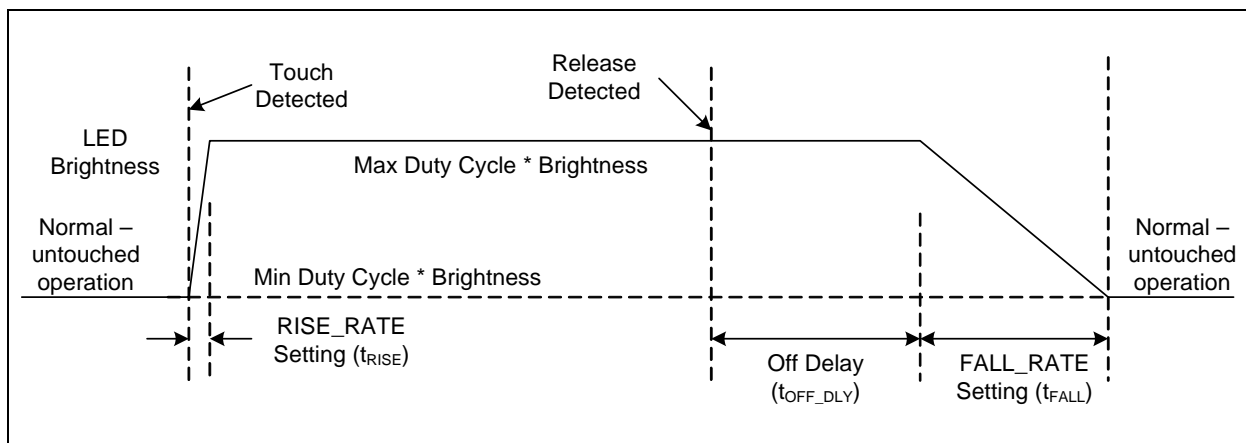

FIGURE 6-6: DIRECT BEHAVIOR FOR INVERTED POLARITY



6.57 Sensor Calibration Registers

TABLE 6-82: SENSOR CALIBRATION REGISTERS

ADDR	Register	R/W	B7	B6	B5	B4	B3	B2	B1	B0	Default
B1h	Sensor 1 Calibration	R	CAL1_9	CAL1_8	CAL1_7	CAL1_6	CAL1_5	CAL1_4	CAL1_3	CAL1_2	00h
B2h	Sensor 2 Calibration	R	CAL2_9	CAL2_8	CAL2_7	CAL2_6	CAL2_5	CAL2_4	CAL2_3	CAL2_2	00h
B3h	Sensor 3 Calibration	R	CAL3_9	CAL3_8	CAL3_7	CAL3_6	CAL3_5	CAL3_4	CAL3_3	CAL3_2	00h
B4h	Sensor 4 Calibration	R	CAL4_9	CAL4_8	CAL4_7	CAL4_6	CAL4_5	CAL4_4	CAL4_3	CAL4_2	00h
B5h	Sensor 5 Calibration	R	CAL5_9	CAL5_8	CAL5_7	CAL5_6	CAL5_5	CAL5_4	CAL5_3	CAL5_2	00h
B6h	Sensor 6 Calibration	R	CAL6_9	CAL6_8	CAL6_7	CAL6_6	CAL6_5	CAL6_4	CAL6_3	CAL6_2	00h

TABLE 6-82: SENSOR CALIBRATION REGISTERS (CONTINUED)

ADDR	Register	R/W	B7	B6	B5	B4	B3	B2	B1	B0	Default
B7h	Sensor 7 Calibration	R	CAL7_9	CAL7_8	CAL7_7	CAL7_6	CAL7_5	CAL7_4	CAL7_3	CAL7_2	00h
B8h	Sensor 8 Calibration	R	CAL8_9	CAL8_8	CAL8_7	CAL8_6	CAL8_5	CAL8_4	CAL8_3	CAL8_2	00h
B9h	Sensor 9 Calibration	R	CAL9_9	CAL9_8	CAL9_7	CAL9_6	CAL9_5	CAL9_4	CAL9_3	CAL9_2	00h
BAh	Sensor 10 Calibration	R	CAL10_9	CAL10_8	CAL10_7	CAL10_6	CAL10_5	CAL10_4	CAL10_3	CAL10_2	00h
BBh	Sensor 11 Calibration	R	CAL11_9	CAL11_8	CAL11_7	CAL11_6	CAL11_5	CAL11_4	CAL11_3	CAL11_2	00h
BCh	Sensor 12 Calibration	R	CAL12_9	CAL12_8	CAL12_7	CAL12_6	CAL12_5	CAL12_4	CAL12_3	CAL12_2	00h
BDh	Sensor 13 Calibration	R	CAL13_9	CAL13_8	CAL13_7	CAL13_6	CAL13_5	CAL13_4	CAL13_3	CAL13_2	00h
BEh	Sensor 14 Calibration	R	CAL14_9	CAL14_8	CAL14_7	CAL14_6	CAL14_5	CAL14_4	CAL14_3	CAL14_2	00h
D0h	Sensor 1 Calibration Low byte	R	CAL4_1	CAL4_0	CAL3_1	CAL3_0	CAL2_1	CAL2_0	CAL1_1	CAL1_0	00h
D1h	Sensor 5 Calibration Low byte	R	CAL8_1	CAL8_0	CAL7_1	CAL7_0	CAL6_1	CAL6_0	CAL5_1	CAL5_0	00h
D2h	Sensor 9 Calibration Low byte	R	CAL12_1	CAL12_0	CAL11_1	CAL11_0	CAL10_1	CAL10_0	CAL9_1	CAL9_0	00h
D3h	Sensor 13 Calibration Low byte	R	-	-	-	-	CAL14_1	CAL14_0	CAL13_1	CAL13_0	00h

The Sensor Calibration Registers hold the 10-bit value that is used for the analog block when each sensor is selected. These registers are read only. They are updated automatically by the digital block when the analog re-calibration routine is performed.

These bits are cleared when the device is placed into Standby or Deep Sleep for all channels that are not sampled.

6.58 Product ID Register

TABLE 6-83: PRODUCT ID REGISTER

ADDR	R/W	Register	B7	B6	B5	B4	B3	B2	B1	B0	Default
FDh	R	Product ID	0	0	1	1	1	0	1	0	3Ah

The Product ID Register stores a unique 8-bit value that identifies the device.

6.59 Revision Register

TABLE 6-84: REVISION REGISTER

ADDR	R/W	Register	B7	B6	B5	B4	B3	B2	B1	B0	Default
FFh	R	Revision	1	0	0	0	0	0	0	0	80h

The Revision Register stores an 8-bit value that represents the part revision.

7.0 PACKAGE INFORMATION

7.1 Package Drawings

FIGURE 7-1: PACKAGE DIAGRAM - 32-PIN QFN

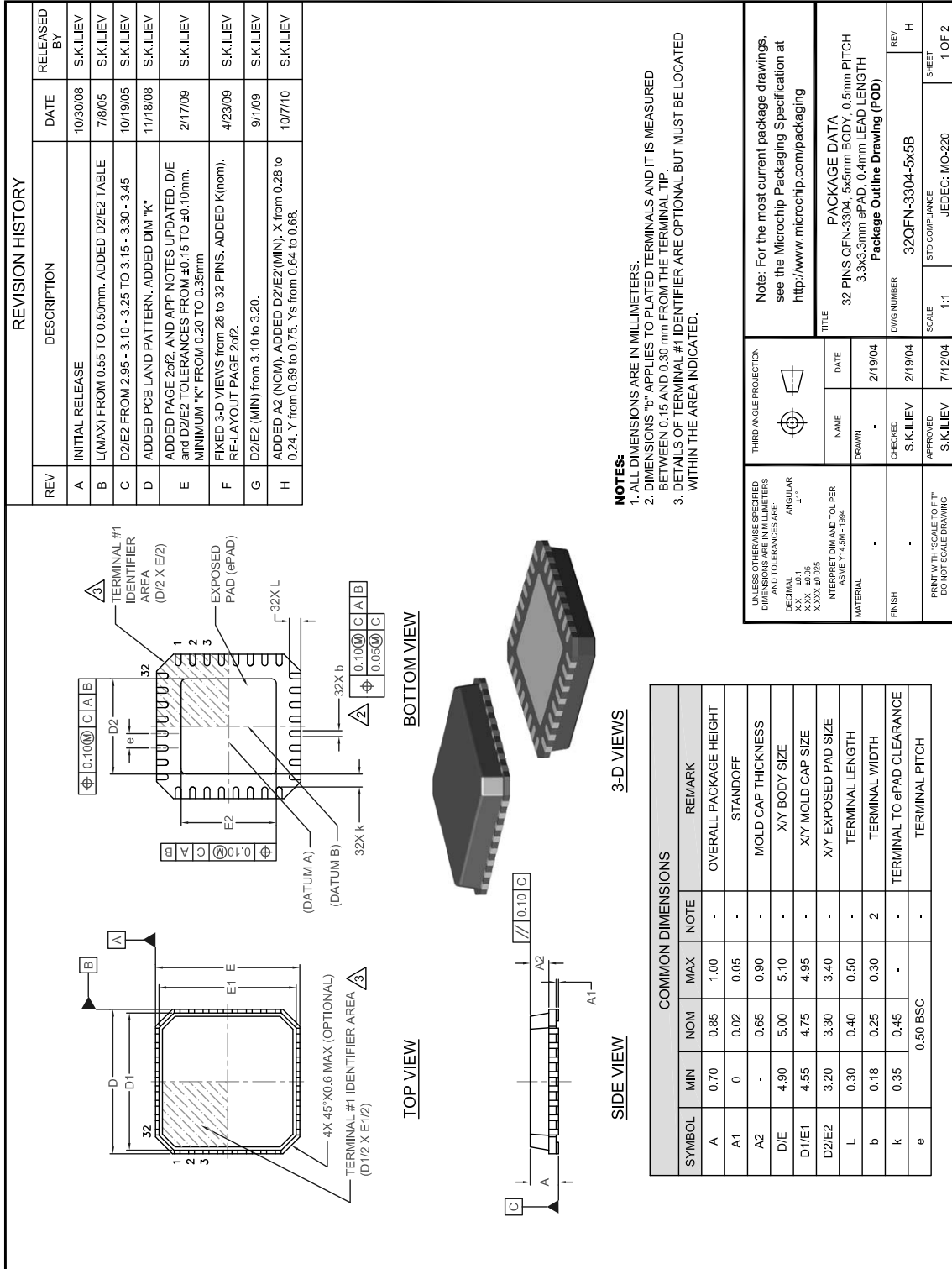
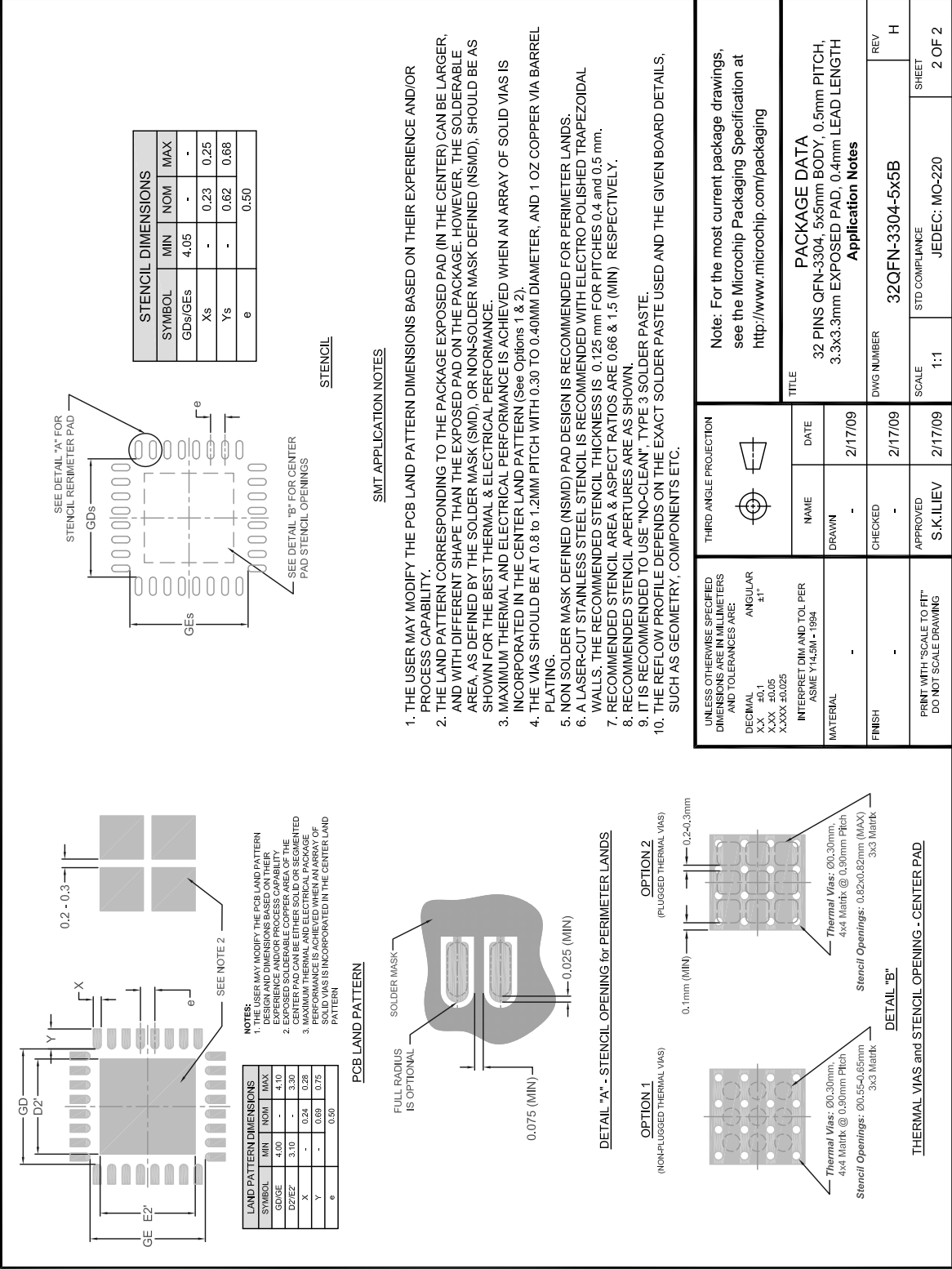

FIGURE 7-1: PACKAGE DIAGRAM - 32-PIN QFN (CONTINUED)



CAP1114

7.2 Package Marking

All packages will be marked as shown in [Figure 7-2](#).

FIGURE 7-2: PACKAGE MARKINGS

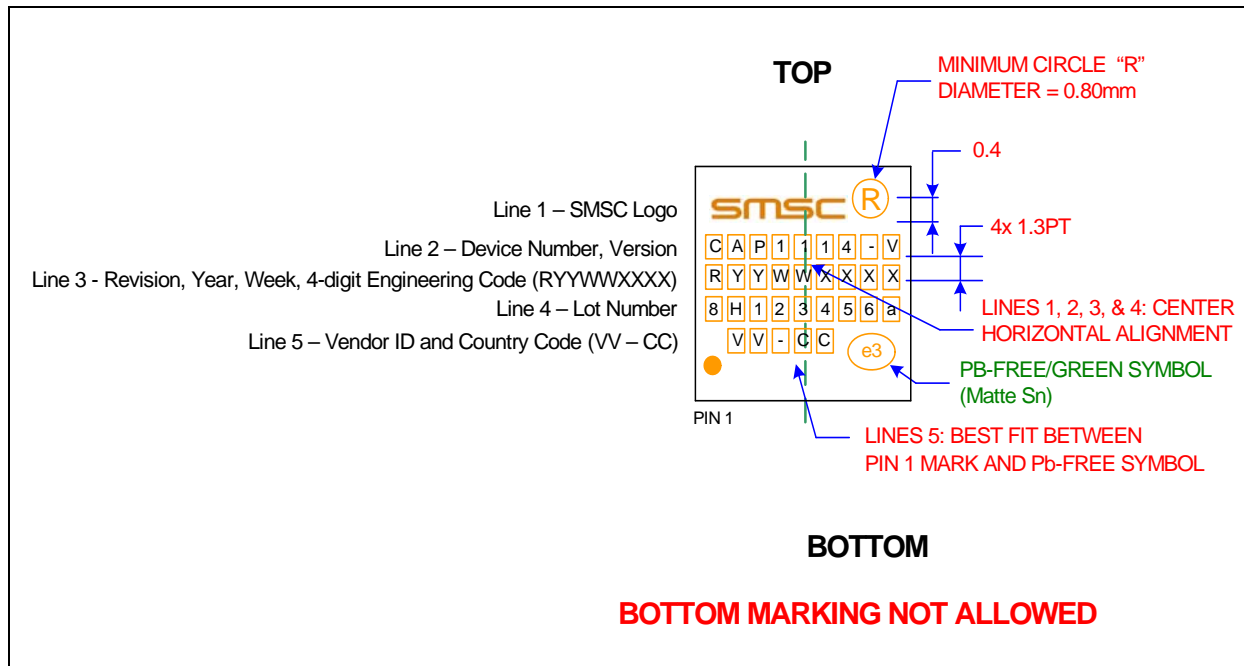

APPENDIX A: DATA SHEET REVISION HISTORY

TABLE A-1: REVISION HISTORY

REVISION LEVEL & DATE	SECTION/FIGURE/ENTRY	CORRECTION
DS00002444A (05-02-17)	Replaces previous SMSC version Rev. 1.1 (02-04-11)	
	Section 4.1.2, "SMBus Address and RD / WR Bit," on page 12	Section modified
Rev. 1.1 (02-04-11)	Cover	RightTouch logo added.
Rev. 1.1 (04-06-10)	Features	Added: "Proximity detection" under "Capacitive Touch Inputs"
	Section 6.36, "Proximity Control Register"	Modified CS1_PROX and PROX_SUM descriptions
	Section 1.0, "Delta from CAP1014 to CAP1114," on page 4	Added delta chapter
	Table 3-2, "Electrical Specifications"	Completed electrical specification values. Changed Time to Communications (t_{COMM}) spec. from 15ms max to 15ms typ and 20ms max. Added drive frequency spec of 2kHz.
	Figure 5-1, "System Diagram for CAP1114"	Added resistors to LED lines.
	Section 5.1, "Power States"	Description for DSLEEP recommended disabling LEDs. Except for LED11, LEDs are driven to non-actuated state with no PWM operations. Users can decide whether to disable or not.
	Section 6.1, "Main Status Control Register"	Description for DSLEEP set to 1 said LEDs (except LED11) are disabled. Instead, they are driven to their programmed non-actuated state and no PWM operations will be done.
	Section 6.34, "Configuration 2 Register"	Renamed INV_LINK_POL to INV_LINK_TRAN. It pertains to Linked LED Transition Controls.
	Section 6.36, "Proximity Control Register"	Added.
	Section 6.44, "LED Output Control Registers"	When LEDs are not linked to capacitive touch sensor channels, LED behaviors can still be used. A bit setting of 1 is activated.
	Section 6.45, "LED Polarity Registers"	Split second application note into three notes to separate inverted versus non-inverted behavior and raise the importance of the assumption of how LEDs are connected. Added reference to system diagram. Clarified description of bit settings. LEDx_POL = 0 is inverted system, and LEDx_POL = 1 is non-inverted system.
	Table 6-64, "LED Polarity Behavior"	Updated table to reflect actual behavior.
	Section 6.46, "Linked LED Transition Control Registers"	Updated. These controls work with the INV_LINK_TRAN bit (not polarity).

CAP1114

TABLE A-1: REVISION HISTORY (CONTINUED)

REVISION LEVEL & DATE	SECTION/FIGURE/ENTRY	CORRECTION
	Section 6.47, "LED Mirror Control"	Updated to clarify.
	Section 6.49, "LED Behavior Registers"	If an LED is not linked and breathing, it must be unactuated for behavior changes to take effect. Clarified explanation of how triggers start and stop.
	Section 6.50, "LED Pulse 1 Period Register"	Removed mirrored figures as behavior is the same. ST_TRIG applies to host drive, too.
	Section 6.51, "LED Pulse 2 Period Register"	The pulse during which the release is detected counts as one of the pulses.
	Section 6.54, "LED Pulse and Breathe Duty Cycle Registers"	Duty cycle changes are only applied immediately in Direct behavior. Removed incorrect application note.
	Section 6.55, "LED Direct Ramp Rates Register"	Ramp rates apply to host control, too.
	Table 6-79, "Rise / Fall Rate Cycle Decode"	For 750ms, bit settings are 011 instead of 111.
	Section 6.56, "LED Off Delay Register"	Removed: "This register is only used if the LED is linked to a Capacitive Touch sensor."
Rev. 1.0 (12-09-09)	Formal release	

THE MICROCHIP WEB SITE

Microchip provides online support via our WWW site at www.microchip.com. This web site is used as a means to make files and information easily available to customers. Accessible by using your favorite Internet browser, the web site contains the following information:

- **Product Support** – Data sheets and errata, application notes and sample programs, design resources, user's guides and hardware support documents, latest software releases and archived software
- **General Technical Support** – Frequently Asked Questions (FAQ), technical support requests, online discussion groups, Microchip consultant program member listing
- **Business of Microchip** – Product selector and ordering guides, latest Microchip press releases, listing of seminars and events, listings of Microchip sales offices, distributors and factory representatives

CUSTOMER CHANGE NOTIFICATION SERVICE

Microchip's customer notification service helps keep customers current on Microchip products. Subscribers will receive e-mail notification whenever there are changes, updates, revisions or errata related to a specified product family or development tool of interest.

To register, access the Microchip web site at www.microchip.com. Under "Support", click on "Customer Change Notification" and follow the registration instructions.

CUSTOMER SUPPORT

Users of Microchip products can receive assistance through several channels:

- Distributor or Representative
- Local Sales Office
- Field Application Engineer (FAE)
- Technical Support

Customers should contact their distributor, representative or field application engineer (FAE) for support. Local sales offices are also available to help customers. A listing of sales offices and locations is included in the back of this document.

Technical support is available through the web site at: <http://www.microchip.com/support>

CAP1114

PRODUCT IDENTIFICATION SYSTEM

To order or obtain information, e.g., on pricing or delivery, refer to the factory or the listed sales office.

<u>PART NO.</u>	<u>[X]</u>	<u>XXX</u>	<u>[X]</u>
Device	Addressing Option	Package	Tape and Reel Option
Device:	CAP1114		
Package:	EZK = 32-pin QFN		
Tape and Reel Option:	Blank = Tray packaging TR = Tape and Reel ⁽¹⁾		

Examples:

- a) CAP1114-1-EZK-TR = 32-pin QFN
RoHS Compliant Package, Tape & Reel
- b) CAP1114-2-EZK-TR = 32-pin QFN
RoHS Compliant Package, Tape & Reel

Note 1: Tape and Reel identifier only appears in the catalog part number description. This identifier is used for ordering purposes and is not printed on the device package. Check with your Microchip Sales Office for package availability with the Tape and Reel option. Reel size is 4,000.

Note the following details of the code protection feature on Microchip devices:

- Microchip products meet the specification contained in their particular Microchip Data Sheet.
- Microchip believes that its family of products is one of the most secure families of its kind on the market today, when used in the intended manner and under normal conditions.
- There are dishonest and possibly illegal methods used to breach the code protection feature. All of these methods, to our knowledge, require using the Microchip products in a manner outside the operating specifications contained in Microchip's Data Sheets. Most likely, the person doing so is engaged in theft of intellectual property.
- Microchip is willing to work with the customer who is concerned about the integrity of their code.
- Neither Microchip nor any other semiconductor manufacturer can guarantee the security of their code. Code protection does not mean that we are guaranteeing the product as “unbreakable.”

Code protection is constantly evolving. We at Microchip are committed to continuously improving the code protection features of our products. Attempts to break Microchip's code protection feature may be a violation of the Digital Millennium Copyright Act. If such acts allow unauthorized access to your software or other copyrighted work, you may have a right to sue for relief under that Act.

Information contained in this publication regarding device applications and the like is provided only for your convenience and may be superseded by updates. It is your responsibility to ensure that your application meets with your specifications. MICROCHIP MAKES NO REPRESENTATIONS OR WARRANTIES OF ANY KIND WHETHER EXPRESS OR IMPLIED, WRITTEN OR ORAL, STATUTORY OR OTHERWISE, RELATED TO THE INFORMATION, INCLUDING BUT NOT LIMITED TO ITS CONDITION, QUALITY, PERFORMANCE, MERCHANTABILITY OR FITNESS FOR PURPOSE. Microchip disclaims all liability arising from this information and its use. Use of Microchip devices in life support and/or safety applications is entirely at the buyer's risk, and the buyer agrees to defend, indemnify and hold harmless Microchip from any and all damages, claims, suits, or expenses resulting from such use. No licenses are conveyed, implicitly or otherwise, under any Microchip intellectual property rights unless otherwise stated.

Trademarks

The Microchip name and logo, the Microchip logo, AnyRate, AVR, AVR logo, AVR Freaks, BeaconThings, BitCloud, CryptoMemory, CryptoRF, dsPIC, FlashFlex, flexPWR, Heldo, JukeBlox, KEELoQ, KEELoQ logo, Klear, LANCheck, LINK MD, maXStylus, maXTouch, MediaLB, megaAVR, MOST, MOST logo, MPLAB, OptoLyzor, PIC, picoPower, PICSTART, PIC32 logo, Prochip Designer, QTouch, RightTouch, SAM-BA, SpyNIC, SST, SST Logo, SuperFlash, tinyAVR, UNI/O, and XMEGA are registered trademarks of Microchip Technology Incorporated in the U.S.A. and other countries.

ClockWorks, The Embedded Control Solutions Company, EtherSynch, Hyper Speed Control, HyperLight Load, IntelliMOS, mTouch, Precision Edge, and Quiet-Wire are registered trademarks of Microchip Technology Incorporated in the U.S.A.

Adjacent Key Suppression, AKS, Analog-for-the-Digital Age, Any Capacitor, AnyIn, AnyOut, BodyCom, chipKIT, chipKIT logo, CodeGuard, CryptoAuthentication, CryptoCompanion, CryptoController, dsPICDEM, dsPICDEM.net, Dynamic Average Matching, DAM, ECAN, EtherGREEN, In-Circuit Serial Programming, ICSP, Inter-Chip Connectivity, JitterBlocker, KlearNet, KlearNet logo, Mindi, MiWi, motorBench, MPASM, MPF, MPLAB Certified logo, MPLIB, MPLINK, MultiTRAK, NetDetach, Omniscient Code Generation, PICDEM, PICDEM.net, PICkit, PICtail, PureSilicon, QMatrix, RightTouch logo, REAL ICE, Ripple Blocker, SAM-ICE, Serial Quad I/O, SMART-I.S., SQI, SuperSwitcher, SuperSwitcher II, Total Endurance, TSHARC, USBCheck, VariSense, ViewSpan, WiperLock, Wireless DNA, and ZENA are trademarks of Microchip Technology Incorporated in the U.S.A. and other countries.

SQTP is a service mark of Microchip Technology Incorporated in the U.S.A.

Silicon Storage Technology is a registered trademark of Microchip Technology Inc. in other countries.

GestIC is a registered trademark of Microchip Technology Germany II GmbH & Co. KG, a subsidiary of Microchip Technology Inc., in other countries.

All other trademarks mentioned herein are property of their respective companies.

© 2009-2017, Microchip Technology Incorporated, All Rights Reserved.

ISBN: 9781522416807

QUALITY MANAGEMENT SYSTEM
CERTIFIED BY DNV
== ISO/TS 16949 ==

Microchip received ISO/TS-16949:2009 certification for its worldwide headquarters, design and wafer fabrication facilities in Chandler and Tempe, Arizona; Gresham, Oregon and design centers in California and India. The Company's quality system processes and procedures are for its PIC® MCUs and dsPIC® DSCs, KEELoQ® code hopping devices, Serial EEPROMs, microperipherals, nonvolatile memory and analog products. In addition, Microchip's quality system for the design and manufacture of development systems is ISO 9001:2000 certified.



Worldwide Sales and Service

AMERICAS

Corporate Office

2355 West Chandler Blvd.
Chandler, AZ 85224-6199

Tel: 480-792-7200

Fax: 480-792-7277

Technical Support:

<http://www.microchip.com/support>

Web Address:

www.microchip.com

Atlanta

Duluth, GA

Tel: 678-957-9614

Fax: 678-957-1455

Austin, TX

Tel: 512-257-3370

Boston

Westborough, MA

Tel: 774-760-0087

Fax: 774-760-0088

Chicago

Itasca, IL

Tel: 630-285-0071

Fax: 630-285-0075

Dallas

Addison, TX

Tel: 972-818-7423

Fax: 972-818-2924

Detroit

Novi, MI

Tel: 248-848-4000

Houston, TX

Tel: 281-894-5983

Indianapolis

Noblesville, IN

Tel: 317-773-8323

Fax: 317-773-5453

Tel: 317-536-2380

Los Angeles

Mission Viejo, CA

Tel: 949-462-9523

Fax: 949-462-9608

Tel: 951-273-7800

Raleigh, NC

Tel: 919-844-7510

New York, NY

Tel: 631-435-6000

San Jose, CA

Tel: 408-735-9110

Tel: 408-436-4270

Canada - Toronto

Tel: 905-695-1980

Fax: 905-695-2078

ASIA/PACIFIC

Asia Pacific Office

Suites 3707-14, 37th Floor
Tower 6, The Gateway
Harbour City, Kowloon

Hong Kong

Tel: 852-2943-5100

Fax: 852-2401-3431

Australia - Sydney

Tel: 61-2-9868-6733

Fax: 61-2-9868-6755

China - Beijing

Tel: 86-10-8569-7000

Fax: 86-10-8528-2104

China - Chengdu

Tel: 86-28-8665-5511

Fax: 86-28-8665-7889

China - Chongqing

Tel: 86-23-8980-9588

Fax: 86-23-8980-9500

China - Dongguan

Tel: 86-769-8702-9880

China - Guangzhou

Tel: 86-20-8755-8029

China - Hangzhou

Tel: 86-571-8792-8115

Fax: 86-571-8792-8116

China - Hong Kong SAR

Tel: 852-2943-5100

Fax: 852-2401-3431

China - Nanjing

Tel: 86-25-8473-2460

Fax: 86-25-8473-2470

China - Qingdao

Tel: 86-532-8502-7355

Fax: 86-532-8502-7205

China - Shanghai

Tel: 86-21-3326-8000

Fax: 86-21-3326-8021

China - Shenyang

Tel: 86-24-2334-2829

Fax: 86-24-2334-2393

China - Shenzhen

Tel: 86-755-8864-2200

Fax: 86-755-8203-1760

China - Wuhan

Tel: 86-27-5980-5300

Fax: 86-27-5980-5118

China - Xian

Tel: 86-29-8833-7252

Fax: 86-29-8833-7256

ASIA/PACIFIC

China - Xiamen

Tel: 86-592-2388138

Fax: 86-592-2388130

China - Zhuhai

Tel: 86-756-3210040

Fax: 86-756-3210049

India - Bangalore

Tel: 91-80-3090-4444

Fax: 91-80-3090-4123

India - New Delhi

Tel: 91-11-4160-8631

Fax: 91-11-4160-8632

India - Pune

Tel: 91-20-3019-1500

Japan - Osaka

Tel: 81-6-6152-7160

Fax: 81-6-6152-9310

Japan - Tokyo

Tel: 81-3-6880-3770

Fax: 81-3-6880-3771

Korea - Daegu

Tel: 82-53-744-4301

Fax: 82-53-744-4302

Korea - Seoul

Tel: 82-2-554-7200

Fax: 82-2-558-5932 or

82-2-558-5934

Malaysia - Kuala Lumpur

Tel: 60-3-6201-9857

Fax: 60-3-6201-9859

Malaysia - Penang

Tel: 60-4-227-8870

Fax: 60-4-227-4068

Philippines - Manila

Tel: 63-2-634-9065

Fax: 63-2-634-9069

Singapore

Tel: 65-6334-8870

Fax: 65-6334-8850

Taiwan - Hsin Chu

Tel: 886-3-5778-366

Fax: 886-3-5770-955

Taiwan - Kaohsiung

Tel: 886-7-213-7830

Taiwan - Taipei

Tel: 886-2-2508-8600

Fax: 886-2-2508-0102

Thailand - Bangkok

Tel: 66-2-694-1351

Fax: 66-2-694-1350

EUROPE

Austria - Wels

Tel: 43-7242-2244-39

Fax: 43-7242-2244-393

Denmark - Copenhagen

Tel: 45-4450-2828

Fax: 45-4485-2829

Finland - Espoo

Tel: 358-9-4520-820

France - Paris

Tel: 33-1-69-53-63-20

Fax: 33-1-69-30-90-79

France - Saint Cloud

Tel: 33-1-30-60-70-00

Germany - Garching

Tel: 49-8931-9700

Germany - Haan

Tel: 49-2129-3766400

Germany - Heilbronn

Tel: 49-7131-67-3636

Germany - Karlsruhe

Tel: 49-721-625370

Germany - Munich

Tel: 49-89-627-144-0

Fax: 49-89-627-144-44

Germany - Rosenheim

Tel: 49-8031-354-560

Israel - Ra'anana

Tel: 972-9-744-7705

Italy - Milan

Tel: 39-0331-742611

Fax: 39-0331-466781

Italy - Padova

Tel: 39-049-7625286

Netherlands - Drunen

Tel: 31-416-690399

Fax: 31-416-690340

Norway - Trondheim

Tel: 47-7289-7561

Poland - Warsaw

Tel: 48-22-3325737

Romania - Bucharest

Tel: 40-21-407-87-50

Spain - Madrid

Tel: 34-91-708-08-90

Fax: 34-91-708-08-91

Sweden - Gothenberg

Tel: 46-31-704-60-40

Sweden - Stockholm

Tel: 46-8-5090-4654

UK - Wokingham

Tel: 44-118-921-5800

Fax: 44-118-921-5820