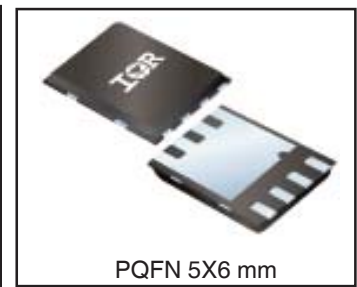
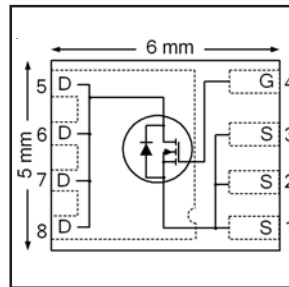


|  |            |                             |
|--|------------|-----------------------------|
| $V_{DS}$                                   | <b>60</b>  | <b>V</b>                    |
| $R_{DS(on) \max}$<br>(@ $V_{GS} = 10V$ )   | <b>6.7</b> | <b>m<math>\Omega</math></b> |
| $Q_g$ (typical)                            | <b>40</b>  | <b>nC</b>                   |
| $R_G$ (typical)                            | <b>1.7</b> | <b><math>\Omega</math></b>  |
| $I_D$<br>(@ $T_{c(Bottom)} = 25^\circ C$ ) | <b>89</b>  | <b>A</b>                    |



### Applications

- Secondary Side Synchronous Rectification
- Inverters for DC Motors
- DC-DC Brick Applications
- Boost Converters

### Features and Benefits

#### Features

|  |
|--|
| Low $R_{DS(on)}$ ( $\leq 7.0m\Omega$ at $V_{GS}=10V$ )       |
| Low Thermal Resistance to PCB ( $\leq 1.2^\circ C/W$ )       |
| 100% Rg tested   |
| Low Profile ( $\leq 0.9$ mm)                                 |
| Industry-Standard Pinout                                     |
| Compatible with Existing Surface Mount Techniques            |
| RoHS Compliant Containing no Lead, no Bromide and no Halogen |
| MSL1, Industrial Qualification                               |

results in  
⇒

#### Benefits

|                                   |
|-----------------------------------|
| Lower Conduction Losses           |
| Enable better thermal dissipation |
| Increased Reliability             |
| Increased Power Density           |
| Multi-Vendor Compatibility        |
| Easier Manufacturing              |
| Environmentally Friendlier        |
| Increased Reliability             |

| Orderable part number | Package Type   | Standard Pack |          | Note             |
|-----------------------|----------------|---------------|----------|------------------|
|                       |                | Form          | Quantity |                  |
| IRFH5206TRPBF         | PQFN 5mm x 6mm | Tape and Reel | 4000     |                  |
| IRFH5206TR2PBF        | PQFN 5mm x 6mm | Tape and Reel | 400      | EOL notice # 259 |

### Absolute Maximum Ratings

|                                       | Parameter                                | Max.         | Units         |
|---------------------------------------|--|--------------|---------------|
| $V_{DS}$                              | Drain-to-Source Voltage                  | 60           | V             |
| $V_{GS}$                              | Gate-to-Source Voltage                   | $\pm 20$     |               |
| $I_D$ @ $T_A = 25^\circ C$            | Continuous Drain Current, $V_{GS}$ @ 10V | 16           | A             |
| $I_D$ @ $T_A = 70^\circ C$            | Continuous Drain Current, $V_{GS}$ @ 10V | 13           |               |
| $I_D$ @ $T_{C(Bottom)} = 25^\circ C$  | Continuous Drain Current, $V_{GS}$ @ 10V | 89           |               |
| $I_D$ @ $T_{C(Bottom)} = 100^\circ C$ | Continuous Drain Current, $V_{GS}$ @ 10V | 56           |               |
| $I_{DM}$                              | Pulsed Drain Current ①                   | 350          |               |
| $P_D$ @ $T_A = 25^\circ C$            | Power Dissipation ⑤                      | 3.6          | W             |
| $P_D$ @ $T_{C(Bottom)} = 25^\circ C$  | Power Dissipation ④                      | 100          |               |
|                                       | Linear Derating Factor (Bottom) ④        | 0.83         | W/ $^\circ C$ |
| $T_J$                                 | Operating Junction and                   | -55 to + 150 | $^\circ C$    |
| $T_{STG}$                             | Storage Temperature Range                |              |               |

Notes ① through ⑥ are on page 9

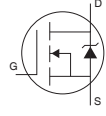
**Static @ T<sub>J</sub> = 25°C (unless otherwise specified)**

|                                     | Parameter   | Min. | Typ. | Max. | Units | Conditions  |
|-------------------------------------|---|------|------|------|-------|---|
| B <sub>V</sub> DSS                  | Drain-to-Source Breakdown Voltage                   | 60   | —    | —    | V     | V <sub>GS</sub> = 0V, I <sub>D</sub> = 250μA  |
| ΔB <sub>V</sub> DSS/ΔT <sub>J</sub> | Breakdown Voltage Temp. Coefficient                 | —    | 0.07 | —    | V/°C  | Reference to 25°C, I <sub>D</sub> = 1mA   |
| R <sub>DS(on)</sub>                 | Static Drain-to-Source On-Resistance                | —    | 5.6  | 6.7  | mΩ    | V <sub>GS</sub> = 10V, I <sub>D</sub> = 50A ③   |
| V <sub>GS(th)</sub>                 | Gate Threshold Voltage                              | 2.0  | —    | 4.0  | V     | V <sub>DS</sub> = V <sub>GS</sub> , I <sub>D</sub> = 100μA  |
| ΔV <sub>GS(th)</sub>                | Gate Threshold Voltage Coefficient                  | —    | -9.7 | —    | mV/°C |   |
| I <sub>DSS</sub>                    | Drain-to-Source Leakage Current                     | —    | —    | 20   | μA    | V <sub>DS</sub> = 60V, V <sub>GS</sub> = 0V   |
|                                     |   | —    | —    | 250  |       | V <sub>DS</sub> = 60V, V <sub>GS</sub> = 0V, T <sub>J</sub> = 125°C   |
| I <sub>GSS</sub>                    | Gate-to-Source Forward Leakage                      | —    | —    | 100  | nA    | V <sub>GS</sub> = 20V   |
|                                     | Gate-to-Source Reverse Leakage                      | —    | —    | -100 |       | V <sub>GS</sub> = -20V  |
| g <sub>fs</sub>                     | Forward Transconductance                            | 73   | —    | —    | S     | V <sub>DS</sub> = 25V, I <sub>D</sub> = 50A   |
| Q <sub>g</sub>                      | Total Gate Charge                                   | —    | 40   | 60   | nC    | V <sub>DS</sub> = 30V<br>V <sub>GS</sub> = 10V<br>I <sub>D</sub> = 50A<br>See Fig.17 & 18                   |
| Q <sub>gs1</sub>                    | Pre-V <sub>th</sub> Gate-to-Source Charge           | —    | 6.2  | —    |       |   |
| Q <sub>gs2</sub>                    | Post-V <sub>th</sub> Gate-to-Source Charge          | —    | 3.4  | —    |       |   |
| Q <sub>gd</sub>                     | Gate-to-Drain Charge                                | —    | 12   | —    |       |   |
| Q <sub>godr</sub>                   | Gate Charge Overdrive                               | —    | 18.4 | —    |       |   |
| Q <sub>sw</sub>                     | Switch Charge (Q <sub>gs2</sub> + Q <sub>gd</sub> ) | —    | 15.4 | —    |       |   |
| Q <sub>oss</sub>                    | Output Charge                                       | —    | 14   | —    | nC    | V <sub>DS</sub> = 16V, V <sub>GS</sub> = 0V   |
| R <sub>G</sub>                      | Gate Resistance                                     | —    | 1.7  | —    | Ω     |   |
| t <sub>d(on)</sub>                  | Turn-On Delay Time                                  | —    | 6.4  | —    | ns    | V <sub>DD</sub> = 30V, V <sub>GS</sub> = 10V<br>I <sub>D</sub> = 50A<br>R <sub>G</sub> = 1.8Ω<br>See Fig.15 |
| t <sub>r</sub>                      | Rise Time   | —    | 11   | —    |       |   |
| t <sub>d(off)</sub>                 | Turn-Off Delay Time                                 | —    | 22   | —    |       |   |
| t <sub>f</sub>                      | Fall Time   | —    | 8.2  | —    |       |   |
| C <sub>iss</sub>                    | Input Capacitance                                   | —    | 2490 | —    | pF    | V <sub>GS</sub> = 0V<br>V <sub>DS</sub> = 25V<br>f = 1.0MHz   |
| C <sub>oss</sub>                    | Output Capacitance                                  | —    | 360  | —    |       |   |
| C <sub>rss</sub>                    | Reverse Transfer Capacitance                        | —    | 160  | —    |       |   |

**Avalanche Characteristics**

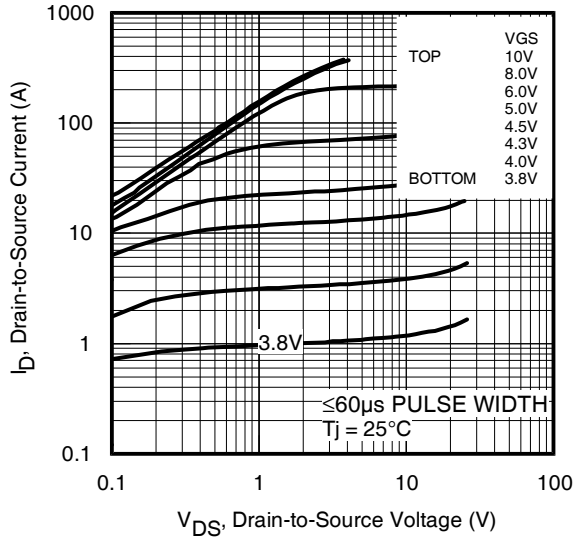
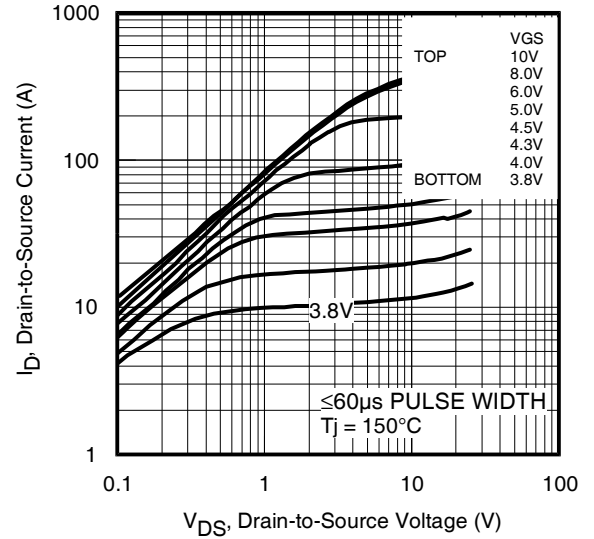
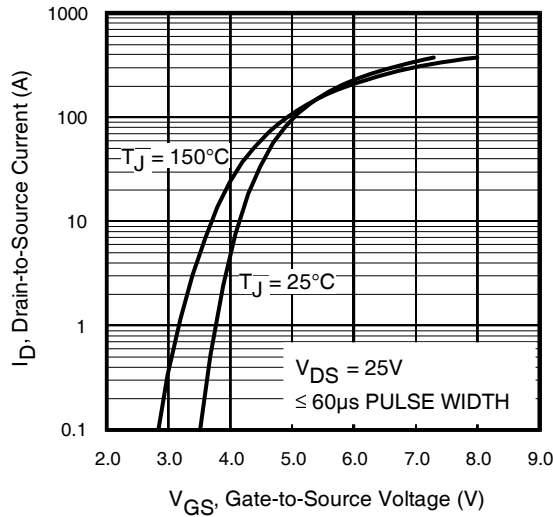
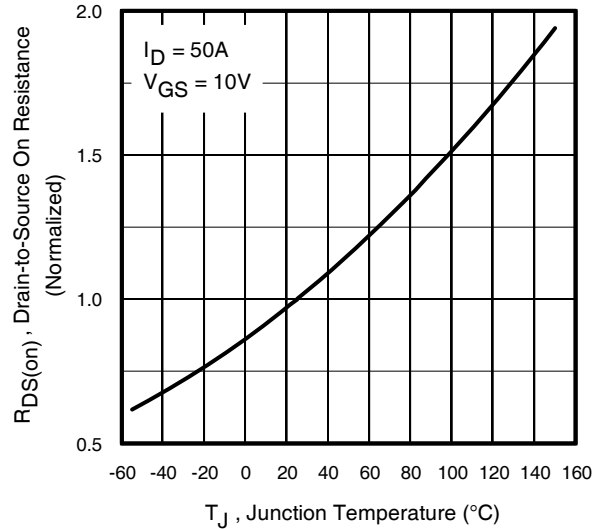
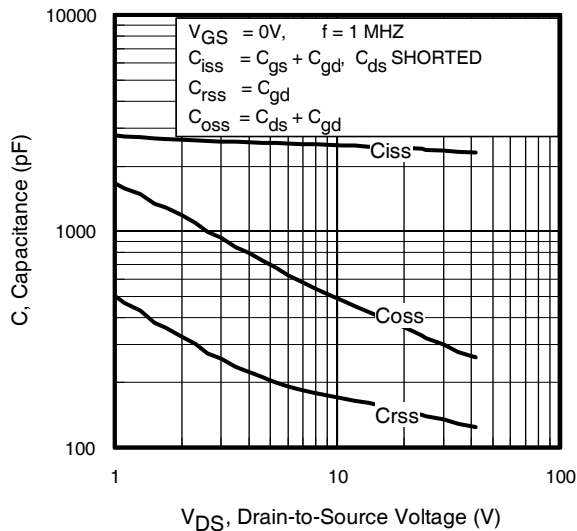
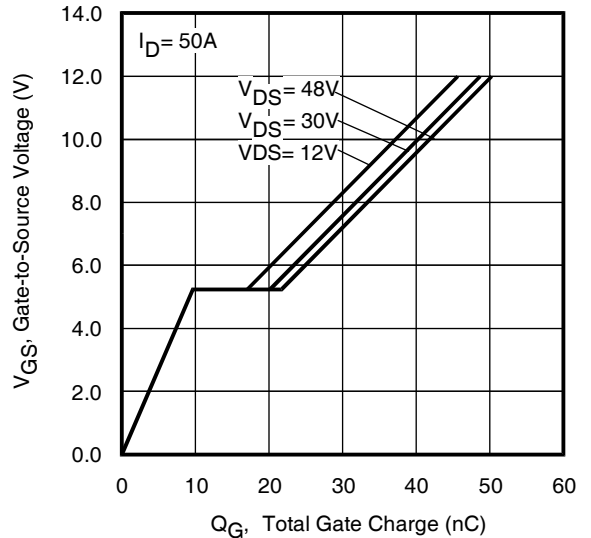
|                 | Parameter                       | Typ. | Max. | Units |
|-----------------|---------------------------------|------|------|-------|
| E <sub>AS</sub> | Single Pulse Avalanche Energy ② | —    | 87   | mJ    |
| I <sub>AR</sub> | Avalanche Current ①             | —    | 50   | A     |

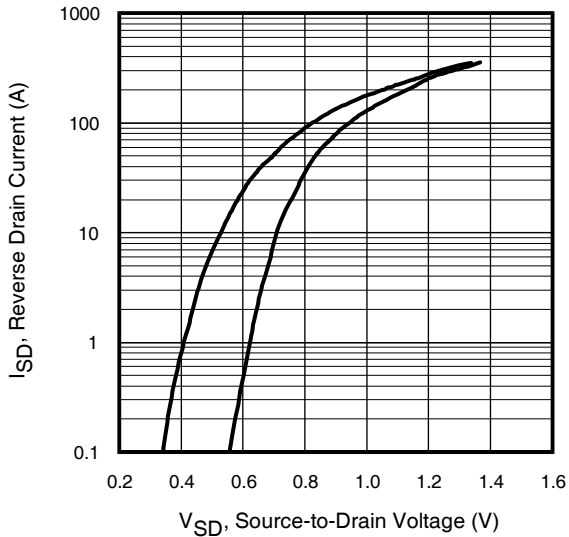
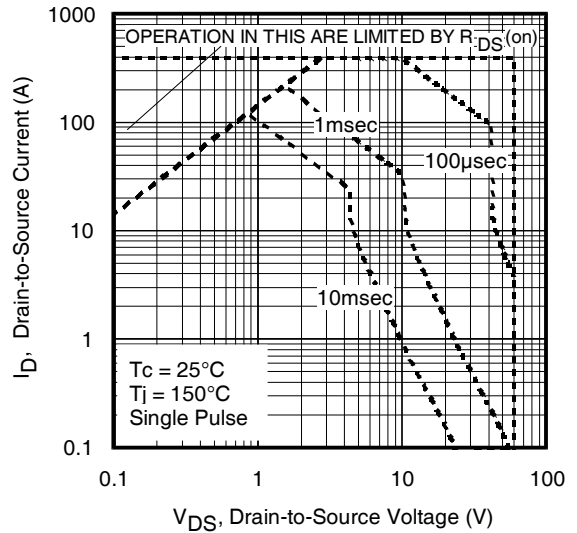
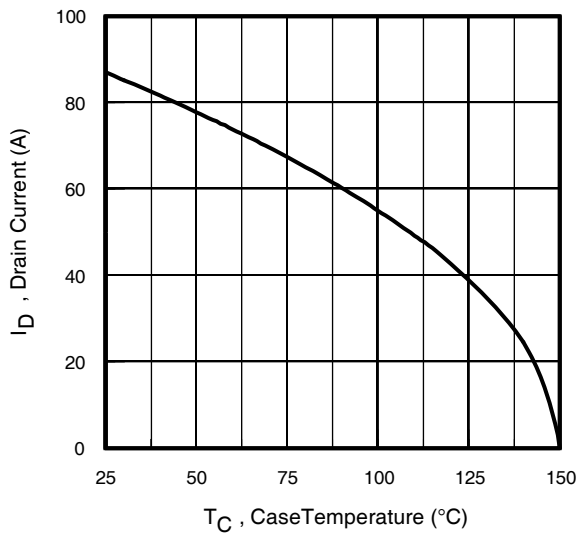
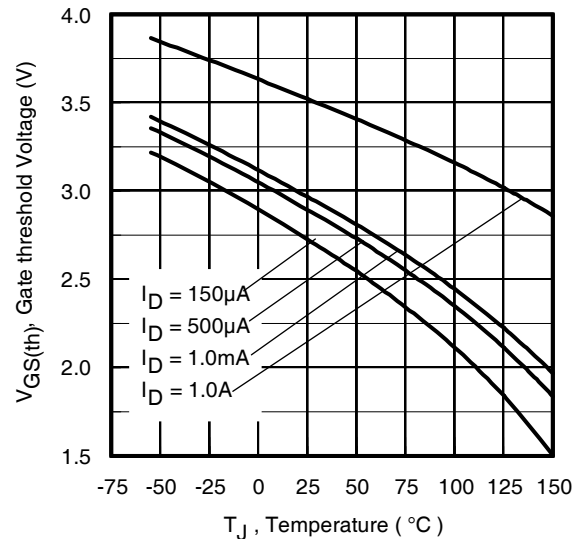
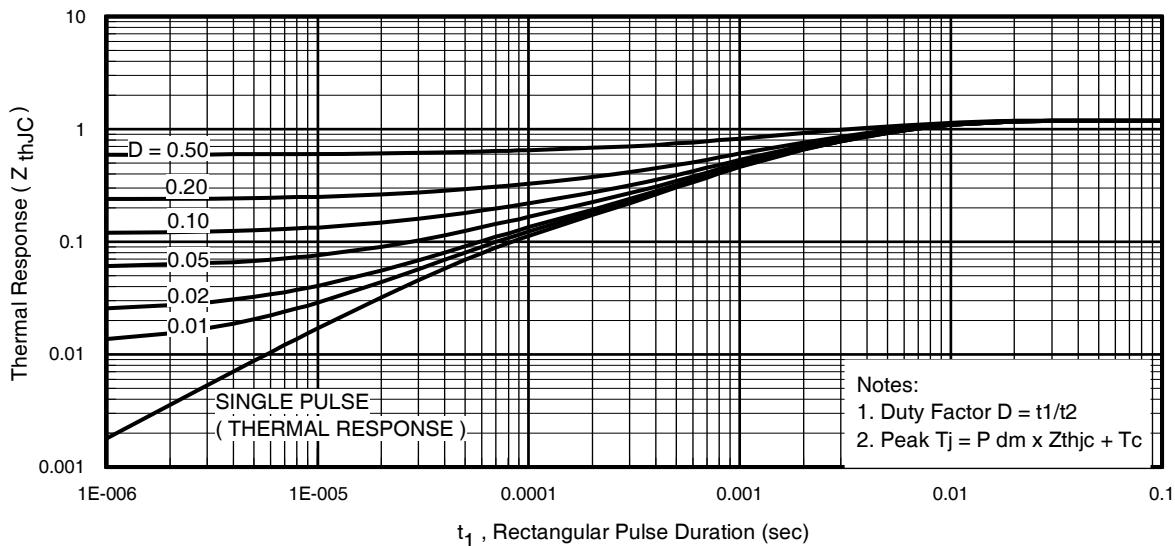
**Diode Characteristics**

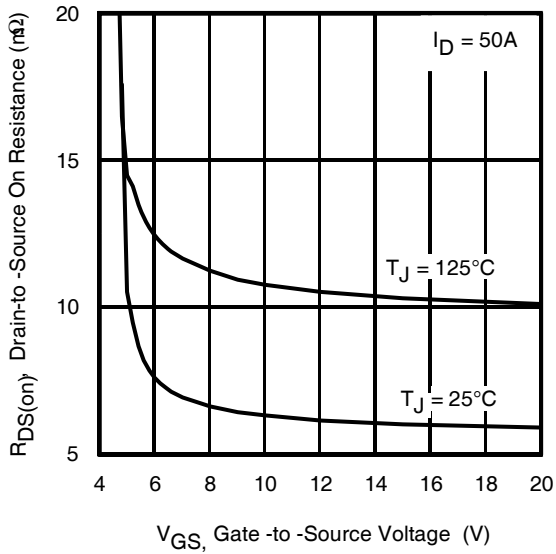
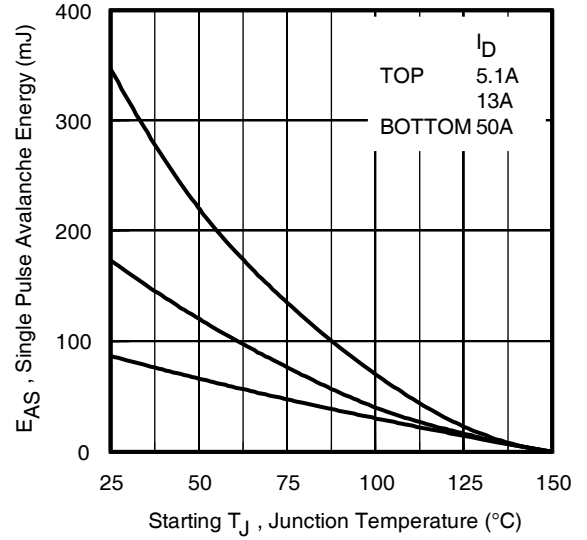
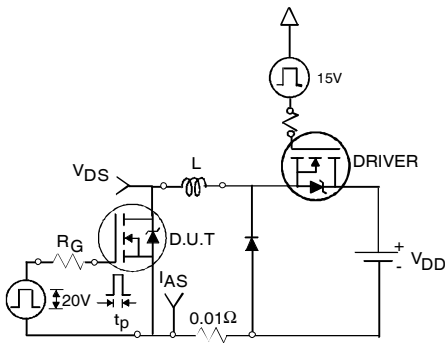
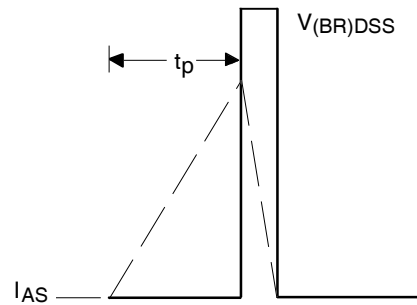
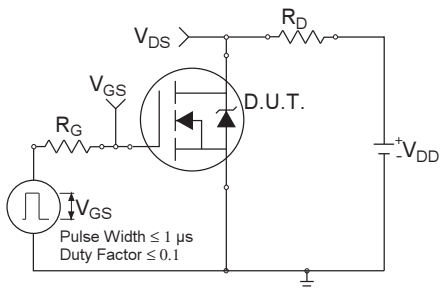
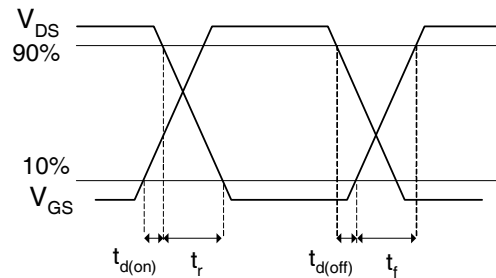
|                 | Parameter                                 | Min.                                      | Typ. | Max. | Units | Conditions  |
|-----------------|---|---|------|------|-------|---|
| I <sub>S</sub>  | Continuous Source Current<br>(Body Diode) | —   | —    | 89   | A     | MOSFET symbol<br>showing the<br>integral reverse<br>p-n junction diode.  |
| I <sub>SM</sub> | Pulsed Source Current<br>(Body Diode) ①   | —   | —    | 350  |       |   |
| V <sub>SD</sub> | Diode Forward Voltage                     | —   | —    | 1.3  | V     | T <sub>J</sub> = 25°C, I <sub>S</sub> = 50A, V <sub>GS</sub> = 0V ③   |
| t <sub>rr</sub> | Reverse Recovery Time                     | —   | 26   | 39   | ns    | T <sub>J</sub> = 25°C, I <sub>F</sub> = 50A, V <sub>DD</sub> = 30V  |
| Q <sub>rr</sub> | Reverse Recovery Charge                   | —   | 110  | 165  | nC    | di/dt = 500A/μs ③   |
| t <sub>on</sub> | Forward Turn-On Time                      | Time is dominated by parasitic Inductance |      |      |       |   |

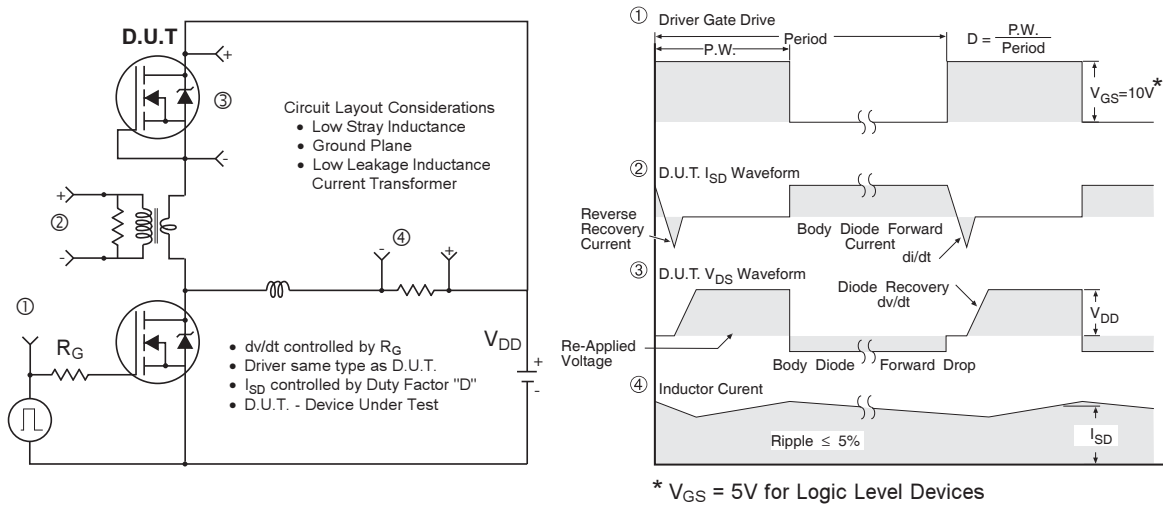
**Thermal Resistance**

|                           | Parameter             | Typ. | Max. | Units |
|---------------------------|-----------------------|------|------|-------|
| R <sub>θJC</sub> (Bottom) | Junction-to-Case ④    | —    | 1.2  | °C/W  |
| R <sub>θJC</sub> (Top)    | Junction-to-Case ④    | —    | 15   |       |
| R <sub>θJA</sub>          | Junction-to-Ambient ⑤ | —    | 35   |       |
| R <sub>θJA</sub> (<10s)   | Junction-to-Ambient ⑤ | —    | 22   |       |

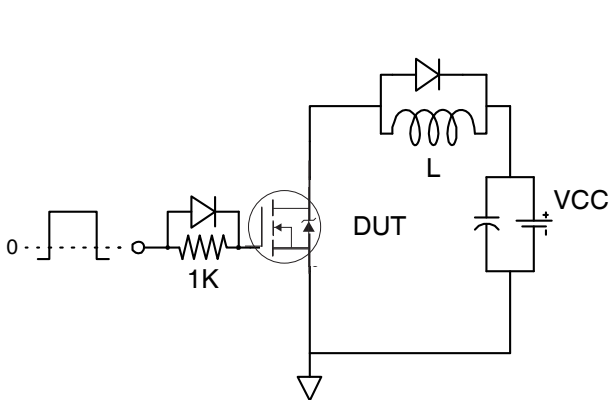

**Fig 1. Typical Output Characteristics**

**Fig 2. Typical Output Characteristics**

**Fig 3. Typical Transfer Characteristics**

**Fig 4. Normalized On-Resistance Vs. Temperature**

**Fig 5. Typical Capacitance Vs. Drain-to-Source Voltage**

**Fig 6. Typical Gate Charge Vs. Gate-to-Source Voltage**


**Fig 7.** Typical Source-Drain Diode Forward Voltage

**Fig 8.** Maximum Safe Operating Area

**Fig 9.** Maximum Drain Current Vs. Case (Bottom) Temperature

**Fig 10.** Threshold Voltage Vs. Temperature

**Fig 11.** Maximum Effective Transient Thermal Impedance, Junction-to-Case (Bottom)

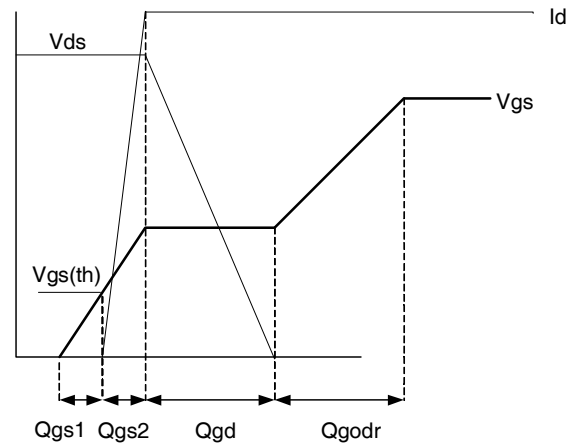

**Fig 12. On-Resistance vs. Gate Voltage**

**Fig 13. Maximum Avalanche Energy vs. Drain Current**

**Fig 14a. Unclamped Inductive Test Circuit**

**Fig 14b. Unclamped Inductive Waveforms**

**Fig 15a. Switching Time Test Circuit**

**Fig 15b. Switching Time Waveforms**



**Fig 16. Peak Diode Recovery  $dv/dt$  Test Circuit for N-Channel HEXFET<sup>®</sup> Power MOSFETs**

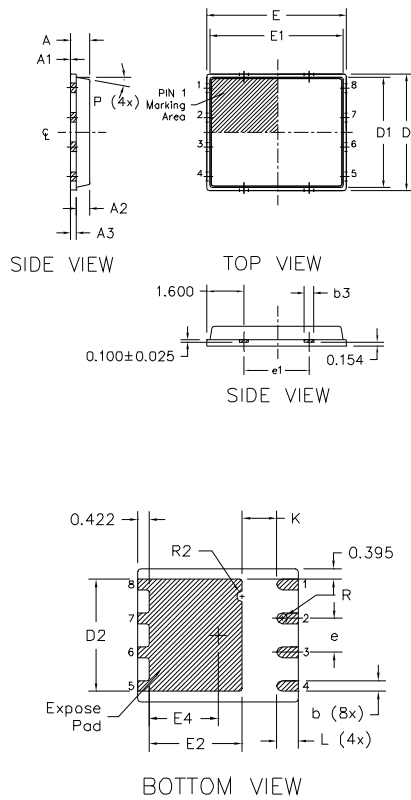


**Fig 17. Gate Charge Test Circuit**



**Fig 18. Gate Charge Waveform**

# PQFN 5x6 Outline "B" Package Details



| DIM<br>SYMBOL | MILLIMETERS |       | INCH       |        |
|---------------|-------------|-------|------------|--------|
|               | MIN         | MAX   | MIN        | MAX    |
| A             | 0.800       | 0.900 | 0.0315     | 0.0543 |
| A1            | 0.000       | 0.050 | 0.0000     | 0.0020 |
| A3            | 0.200 REF   |       | 0.0079 REF |        |
| b             | 0.350       | 0.470 | 0.0138     | 0.0185 |
| b1            | 0.025       | 0.125 | 0.0010     | 0.0049 |
| b2            | 0.210       | 0.410 | 0.0083     | 0.0161 |
| b3            | 0.150       | 0.450 | 0.0059     | 0.0177 |
| D             | 5.000 BSC   |       | 0.1969 BSC |        |
| D1            | 4.750 BSC   |       | 0.1870 BSC |        |
| D2            | 4.100       | 4.300 | 0.1614     | 0.1693 |
| E             | 6.000 BSC   |       | 0.2362 BSC |        |
| E1            | 5.750 BSC   |       | 0.2264 BSC |        |
| E2            | 3.380       | 3.780 | 0.1331     | 0.1488 |
| e             | 1.270 REF   |       | 0.0500 REF |        |
| e1            | 2.800 REF   |       | 0.1102 REF |        |
| K             | 1.200       | 1.420 | 0.0472     | 0.0559 |
| L             | 0.710       | 0.900 | 0.0280     | 0.0354 |
| P             | 0°          | 12°   | 0°         | 12°    |
| R             | 0.200 REF   |       | 0.0079 REF |        |
| R2            | 0.150       | 0.200 | 0.0059     | 0.0079 |

**Note:**

1. Dimensions and tolerancing confirm to ASME Y14.5M-1994
2. Dimension L represents terminal full back from package edge up to 0.1mm is acceptable
3. Coplanarity applies to the expose Heat Slug as well as the terminal
4. Radius on terminal is Optional

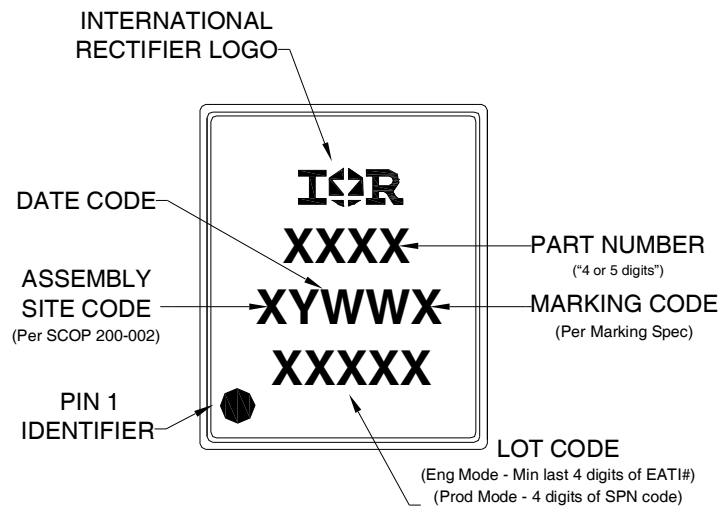
For more information on board mounting, including footprint and stencil recommendation, please refer to application note AN-1136:

<http://www.irf.com/technical-info/appnotes/an-1136.pdf>

For more information on package inspection techniques, please refer to application note AN-1154:

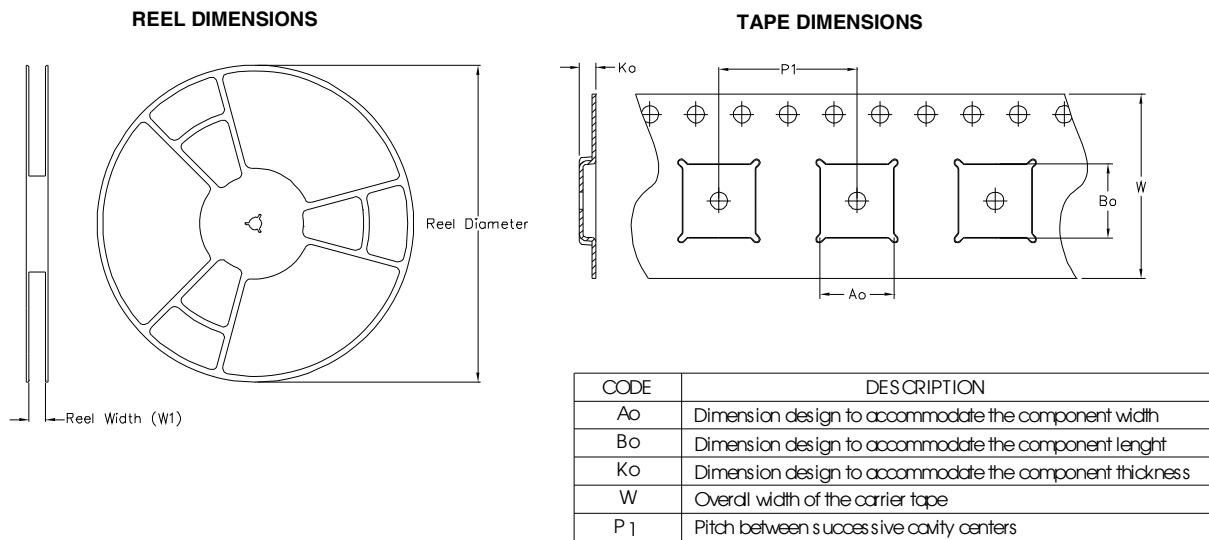
<http://www.irf.com/technical-info/appnotes/an-1154.pdf>

## PQFN 5x6 Part Marking

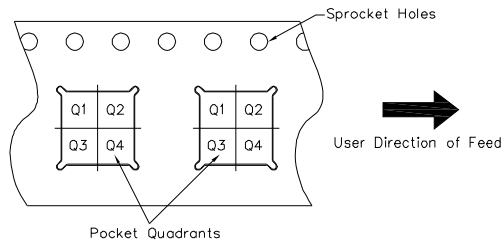


**Note:** For the most current drawing please refer to IR website at: <http://www.irf.com/package/>

# PQFN Tape and Reel



**QUADRANT ASSIGNMENTS FOR PIN 1 ORIENTATION IN TAPE**



Note: All dimension are nominal

| Package Type | Reel Diameter (Inch) | QTY  | Reel Width W1 (mm) | Ao (mm) | Bo (mm) | Ko (mm) | P1 (mm) | W (mm) | Pin 1 Quadrant |
|--------------|----------------------|------|--------------------|---------|---------|---------|---------|--------|----------------|
| 5 X 6 PQFN   | 13                   | 4000 | 12.4               | 6.300   | 5.300   | 1.20    | 8.00    | 12     | Q1             |

Note: For the most current drawing please refer to IR website at: <http://www.irf.com/package/>



**Qualification information<sup>†</sup>**

|                            |   |  |
|----------------------------|---|--|
| Qualification level        | Industrial <sup>††</sup><br>(per JEDEC JESD47F <sup>†††</sup> guidelines) |  |
| Moisture Sensitivity Level | PQFN 5mm x 6mm  | MSL 1<br>(per JEDEC J-ST D-020D <sup>†††</sup> ) |
| RoHS compliant             | Yes   |  |

† Qualification standards can be found at International Rectifier's web site  
<http://www.irf.com/product-info/reliability>

†† Higher qualification ratings may be available should the user have such requirements.  
 Please contact your International Rectifier sales representative for further information:  
<http://www.irf.com/whoto-call/salesrep/>

††† Applicable version of JEDEC standard at the time of product release.

**Notes:**

- ① Repetitive rating; pulse width limited by max. junction temperature.
- ② Starting  $T_J = 25^\circ\text{C}$ ,  $L = 0.07\text{mH}$ ,  $R_G = 25\Omega$ ,  $I_{AS} = 50\text{A}$ .
- ③ Pulse width  $\leq 400\mu\text{s}$ ; duty cycle  $\leq 2\%$ .
- ④  $R_\theta$  is measured at  $T_J$  of approximately  $90^\circ\text{C}$ .
- ⑤ When mounted on 1 inch square 2 oz copper pad on 1.5x1.5 in. board of FR-4 material.
- ⑥ Calculated continuous current based on maximum allowable junction temperature. Package is limited to 100A by production test capability

**Revision History**

| Date      | Comment  |
|-----------|--|
| 5/14/2014 | <ul style="list-style-type: none"> <li>• Updated ordering information to reflect the End-Of-life (EOL) of the mini-reel option (EOL notice #259)</li> <li>• Updated Package outline on page 7.</li> <li>• Updated data sheet based on corporate template.</li> </ul> |
| 3/19/2015 | <ul style="list-style-type: none"> <li>• Updated package outline and tape and reel on pages 7 and 8.</li> </ul>  |